



NIVA 3



RNS 1-2

## RNS-1, RNS-2 et NIVA 3

de régulation de niveau paramétrable

Réf : PF10L006 / PF10L002 / PF10L009

### Table des matières

1. Caractéristiques techniques .....	2
2. Contenu de l'emballage .....	3
3. Installation .....	3
3.1. Raccordement électrique .....	3
4. Fonctionnement de l'appareil - description des fonctions .....	6
4.1. Fonctionnalités disponibles (selon version) .....	6
5. Installation des accessoires .....	7
5.1. Flotteur MFP-2 (RNS-1) .....	7
5.2. Sonde SE-3 (RNS-2) .....	7
5.3. Sondes SE-1 (Niva-3) .....	8
<b>A. Déclaration de conformité .....</b>	<b>8</b>



**Lire attentivement cette notice avant d'installer, de mettre en service, ou d'utiliser ce produit.**

## 1. Caractéristiques techniques

Tension d'alimentation	230V AC - 50Hz
Dimensions hors tout	220 x 200 x 150 mm
Indice de protection	IP-55
Capteur de niveau	Selon modèle : <ul style="list-style-type: none"><li>• 1 flotteur MFP2 (SF140008) = <b>RNS-1</b></li><li>• 1 sonde SE-3 (SF140005) = <b>RNS-2</b></li><li>• 3 sondes SE-1 (SF140017) = <b>NIVA-3</b></li></ul>
Sorties	1 sortie 24V AC - 6VA pour électrovanne 1 sortie contact sec pour gérer l'interdit pompe



**Sortie marche forcée et voyant correspondant**  **non actif sur RNS-1, RNS-2 et NIVA 3**

## 2. Contenu de l'emballage

1 coffret RNS-1, RNS-2 et NIVA 3	1 filtre tamis (pression max 4 bar)
1 électrovanne 24V	1 Notice technique (ce document)
1 capteur de niveau (différent selon modèle)	

## 3. Installation

### 3.1. Raccordement électrique



L'installation de ce produit peut vous exposer à des chocs électriques. Il est vivement recommandé de faire appel à une personne qualifiée. Une erreur d'installation peut vous mettre en danger et endommager de façon irréversible le produit et les équipements qui lui sont raccordés.



Pour des raisons de sécurité et conformément à la norme NF C15-100, le coffret dans lequel est installé le RNS-1, RNS-2 et NIVA 3 doit être installé

- soit à plus de 3m50 du bord de la piscine. Cette distance s'apprécie en prenant en compte le contournement des obstacles. Si le coffret du RNS-1, RNS-2 et NIVA 3 est installé derrière un mur, il s'agit donc de la distance nécessaire pour faire le tour et rejoindre le coffret.
- soit dans un local enterré à proximité immédiate de la piscine. Dans ce cas le local doit être accessible par une trappe nécessitant un outil pour son ouverture.
- après une protection différentielle de haute sensibilité (30mA) conformément à la norme NF C15-100

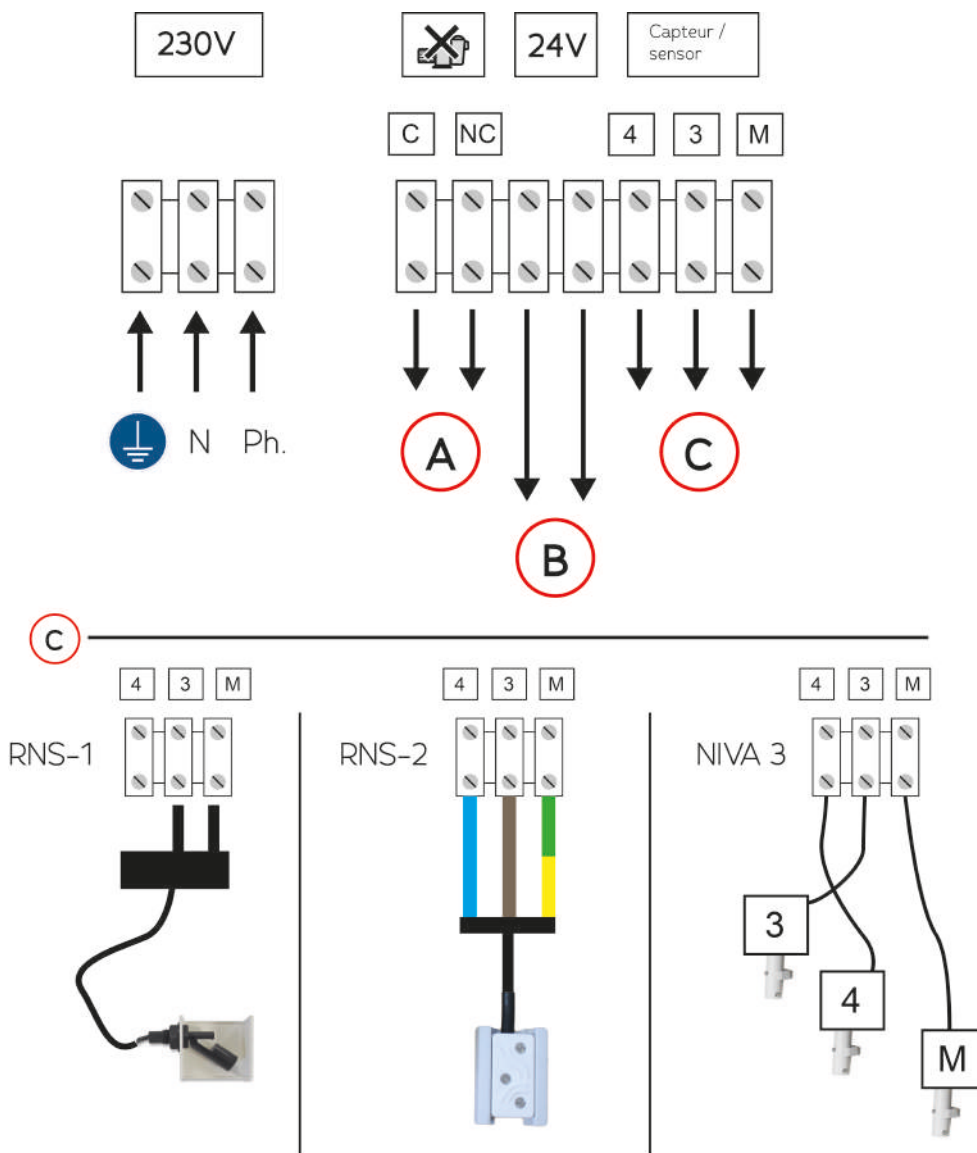

- A. Interdit pompe (voir plus loin pour plus de détail)
- B. Sortie 24V pour électrovanne
- C. Raccordement du capteur de niveau fourni avec le coffret.

*Selon le capteur de niveau utilisé, le raccordement est différent. La partie inférieure de l'image (C) décrit les raccordements possibles.*

### 3.1.1. Raccordement interdit pompe

#### 3.1.1.1. Sur un coffret électrique de la marque CCEI

Les coffrets électriques fabriqués par CCEI sont équipés d'un bornier pré-raccordé, repéré ABCD pour les régulations de niveau automatique.

- **A et B** : marche forcée de la pompe de filtration (non utilisé pour les RNS-1, RNS-2 et NIVA 3)
- **C et D** : interdit pompe

Il suffit alors d'enlever le "shunt" existant entre C et D sur le coffret filtration et de brancher à la place les 2 fils venants de la sortie "Interdit pompe" du coffret RNS-1, RNS-2 et NIVA 3.

#### 3.1.1.2. Sur un coffret électrique standard

Si le coffret électrique n'est pas pré-équipé pour une régulation de niveau automatique, il faut se brancher directement sur le contacteur de filtration. Les informations suivantes sont données à titre indicatif et il est impératif de suivre la notice de votre coffret électrique de piscine ou de contacter au préalable le fabricant de votre coffret.

#### Interdit pompe :

Reliez le bornier Interdit pompe sur la borne A1 du contacteur de filtration

- **A** : fils existants dans le coffret de filtration
- **B** : contacteur de filtration installé dans le coffret
- **C** : fil à ajouter pour raccorder l'interdit pompe au coffret RNS-1, RNS-2 et NIVA 3

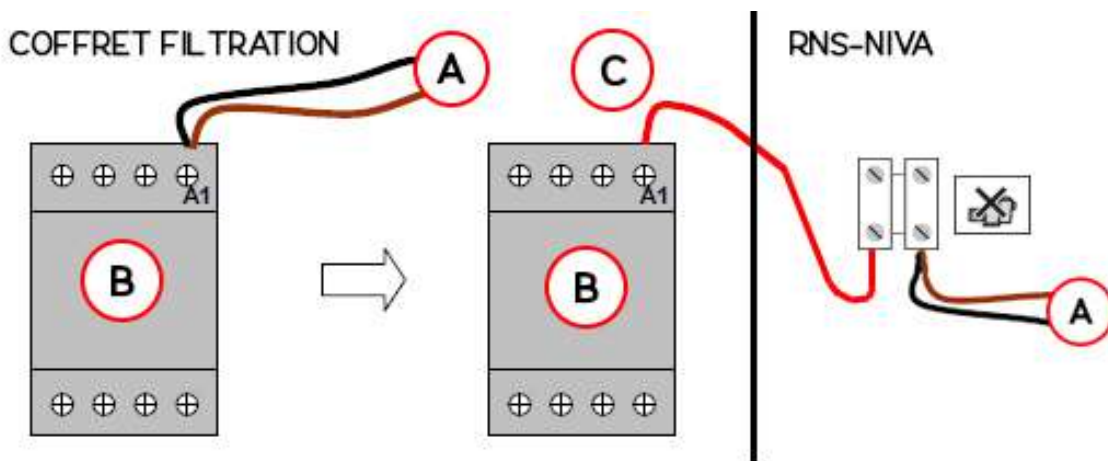

Débrancher le ou les fils arrivant sur la borne A1 du contacteur de filtration et les envoyer sur une borne du domino "Interdit pompe" du coffret RNS-1, RNS-2 et NIVA 3. Relier, ensuite par un fil l'autre borne du domino "Interdit pompe" à la borne A1 du contacteur de filtration.

## 4. Fonctionnement de l'appareil - description des fonctions

### 4.1. Fonctionnalités disponibles (selon version)

#### 4.1.1. Temporisation

Afin de rendre le système insensible au clapot, le dispositif électronique temporise la détection d'un changement de niveau. Ainsi le dispositif n'ouvre l'électrovanne de remplissage que lorsque le niveau détecté reste en dessous du niveau de seuil pendant 10 secondes.

De même l'électrovanne se fermera que lorsque le niveau s'est stabilisé au dessus du seuil durant 5 secondes.

#### 4.1.2. Sortie interdit pompe

Le RNS-1, RNS-2 et NIVA 3 dispose d'une sortie Interdit Pompe qui permet d'éviter que la pompe ne tourne en situation de manque d'eau.

#### 4.1.3. Sortie électrovanne de remplissage

Sur cette sortie, le RNS-1, RNS-2 et NIVA 3 envoie du 24V alternatif lorsque le remplissage est requis. Reliez cette sortie à l'électrovanne fournie avec le module. Lorsque le remplissage est actif,

la LED



s'allume.

##### 4.1.3.1. Défaut de remplissage

Si le niveau haut n'est pas atteint au bout de 3 heures, le coffret entre en surveillance pour 30 minutes

et le voyant  est allumé en orange (LEDs vertes + rouges). Au bout de 30 minutes, si le niveau

n'est toujours pas atteint, le remplissage est coupé et l'interdit pompe reste activé par sécurité. Le

voyant  est alors allumé en rouge.

Il faut alors contrôler le capteur de niveau et l'électrovanne de remplissage. Pour annuler le défaut, il faut éteindre et rallumer l'appareil.

## 5. Installation des accessoires

### 5.1. Flotteur MFP-2 (RNS-1)

	<p>Le flotteur MFP-2 se fixe dans du skimmer. Utiliser de préférence de la colle silicone ou néoprène et veillez à ne pas empêcher la sortie du panier filtrant.</p> <p>A. Flotteur</p> <p>L'appareil agit comme un "tout ou rien". La hauteur du flotteur varie en fonction du niveau de l'eau et lorsque celui-ci est en dessous de la position horizontale (par exemple comme sur la photo), il actionne le remplissage et l'interdit pompe.</p> <p>Une fois le niveau d'eau atteint, l'appareil stoppe le remplissage et remet en route la pompe de filtration.</p>
-----------------------------------------------------------------------------------	-------------------------------------------------------------------------------------------------------------------------------------------------------------------------------------------------------------------------------------------------------------------------------------------------------------------------------------------------------------------------------------------------------------------------------------------------------------------------------------------------------------------------------------------------------------------------

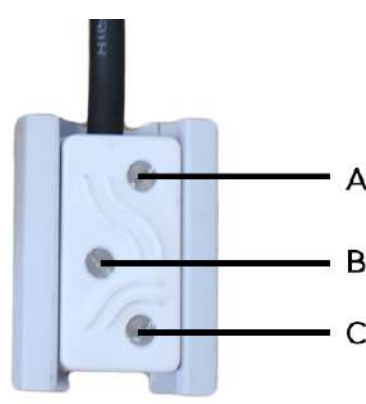

### 5.2. Sonde SE-3 (RNS-2)

	<p>La sonde SE-3 se fixe dans le skimmer. Utiliser de préférence de la colle silicone ou néoprène.</p> <p>A. Niveau haut B. Niveau bas C. Niveau ref.</p> <p>Si le niveau de l'eau est au dessus du niveau haut (A), la filtration est autorisée et le remplissage automatique arrêté.</p> <p>Si le niveau de l'eau se situe sous le niveau bas (B), l'appareil stoppe la filtration (interdit pompe) et active le remplissage jusqu'à atteindre le niveau haut (A).</p>
-------------------------------------------------------------------------------------	----------------------------------------------------------------------------------------------------------------------------------------------------------------------------------------------------------------------------------------------------------------------------------------------------------------------------------------------------------------------------------------------------------------------------------------------------------------------------------

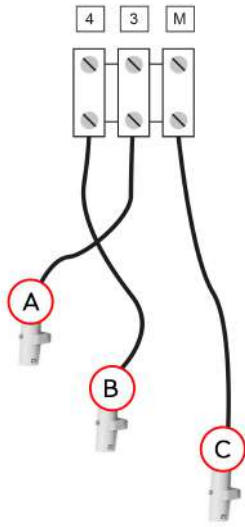
### 5.3. Sondes SE-1 (Niva-3)

	<p>Les 3 sondes SE-3 sont positionnés dans le skimmer, écartées les unes des autres. <b>Nous recommandons</b> de les installer dans une goulotte ou un tuyau PVC pour les isoler de la paroi et les maintenir séparées. Les sondes doivent être fixées à la hauteur voulue afin d'empêcher leur mouvement et d'éviter toute traction sur leur fil. Les fils des sondes doivent être guidées de façon à éviter leur enchevêtrement.</p> <p>A. Niveau haut (à raccorder sur la borne 3)          B. Niveau bas (à raccorder sur la borne 4)          C. Niveau ref. (à raccorder sur la borne M)</p> <p>Si le niveau de l'eau est au dessus du niveau haut (<b>A</b>), la filtration est autorisée et le remplissage automatique arrêté.</p> <p>Si le niveau de l'eau se situe sous le niveau bas (<b>B</b>), l'appareil stoppe la filtration (interdit pompe) et active le remplissage jusqu'à atteindre le niveau haut (<b>A</b>), ou l'arrête au bout de 3 heures (voir paragraphe Défaut)</p>
-----------------------------------------------------------------------------------	---------------------------------------------------------------------------------------------------------------------------------------------------------------------------------------------------------------------------------------------------------------------------------------------------------------------------------------------------------------------------------------------------------------------------------------------------------------------------------------------------------------------------------------------------------------------------------------------------------------------------------------------------------------------------------------------------------------------------------------------------------------------------------------------------------------------------------------------------------------------------------------------------------------------------------------------------------------------------------------------------------

## A. Déclaration de conformité

<p>La société CCEI S.A.S (FR 47 40 35 21 693) déclare que le produit RNS-1, RNS-2 et NIVA 3 satisfait aux exigences de sécurité et de compatibilité électromagnétique des directives européennes 2014/35/UE et 2014/30/UE.</p>		
		<p>Emmanuel Baret              Marseille, le 15/05/2019</p>
<p style="text-align: center;"><b>Cachet Distributeur</b></p>		
<p>Date de la vente : ..... N° de lot : .....</p>		





NIVA 3



RNS 1-2

## RNS-1, RNS-2 and NIVA 3 Module

level regulation module

Réf : PF10L006 / PF10L002 / PF10L009

### Table des matières

1. Technical specifications .....	2
2. Pack contents .....	3
3. Installation .....	3
3.1. Connection to electricity .....	3
4. Device operation - function description .....	6
4.1. Available features (depending on the version) .....	6
5. Installing the accessories .....	7
5.1. MFP-2 floater (RNS-1) .....	7
5.2. SE-3 sensor (RNS-2) .....	7
5.3. SE-1 sensors (Niva-3) .....	8
<b>A. Declaration of conformity .....</b>	<b>8</b>



**Read these instructions carefully before installing, commissioning and using this product**

## 1. Technical specifications

Power supply voltage	230V AC - 50Hz
Dimensions:	220 x 200 x 150 mm
Protection factor	IP-55
Level sensor	Depending on the model: <ul style="list-style-type: none"> <li>• 1 MFP2 (SF140008) floater = <b>RNS-1</b></li> <li>• 1 SE-3 (SF140005) sensor = <b>RNS-2</b></li> <li>• 3 SE-1 (SF140017) sensors = <b>NIVA-3</b></li> </ul>
Outputs	1 24V AC - 6VA output for solenoid 1 dry contact output to manage pump prohibition



**Forced operation output and corresponding indicator**



**not active on**

**RNS-1, RNS-2 and NIVA 3 Module**

## 2. Pack contents

1 module RNS-1, RNS-2 and NIVA 3 Module	1 screen filter (max pressure 4 bars)
1 24V solenoid	1 Technical manual (this document)
1 level sensor (different depending on the model)	

## 3. Installation

### 3.1. Connection to electricity



**Installation of this project involves a hazard of electric shocks. We strongly recommend you contract a professional installer. Incorrect installation places you in danger and may irreversibly damage the product and the equipment connected to it.**



**For safety reasons and in compliance with the NF C15-100 standard, the box in which the RNS-1, RNS-2 and NIVA 3 Module is installed must be**

- **either at 3.50 m from the pool edge. This distance takes into account the distance around obstacles. If the RNS-1, RNS-2 and NIVA 3 Module control box is installed behind a wall, the distance will include the length of the path taken to move around the wall to reach the box.**
- **or in an in-ground space immediately next to the swimming pool. In this case the space must be accessible via a hatch which requires a tool to open it.**
- **downstream of a high sensitivity ground fault protection (30mA) in compliance with the NF C15-100 standard**

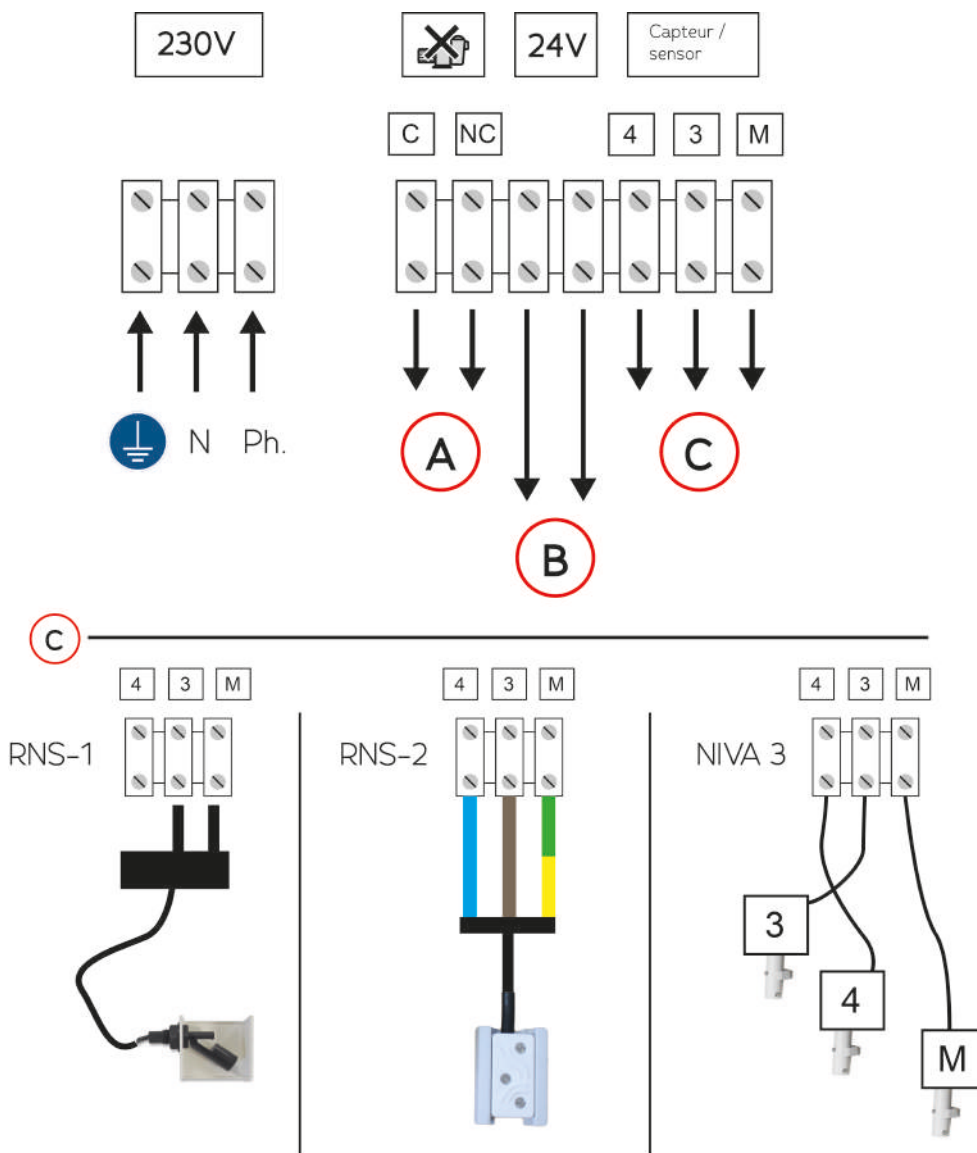

- A. Pump prohibition (see below for more details)
- B. 24V output for solenoid
- C. Level sensor connection supplied with the box.

*The connection differs depending on the level sensor being used. The lower part of the image (C) describes the possible connections.*

### 3.1.1. Pump prohibition connection

#### 3.1.1.1. To a CCEI brand electric box

The electric boxes manufactured by CCEI are fitted with a pre-connected terminal block marked ABCD for automatic level regulators.

- **A and B:** filtration pump forced operation (not used for RNS-1, RNS-2 and NIVA 3 Module)
- **C and D:** pump prohibition

All that remains to do is to remove the "shunt" between C and D on the filtration box and to connect the 2 wires from the "Pump prohibition" output of the RNS-1, RNS-2 and NIVA 3 Module box instead.

#### 3.1.1.2. On a standard electric box

If the electric box is not pre-fitted for automatic level regulation, connect directly to the filtration contact . The following information is given as an indication only. It is imperative to follow the instructions for your pool electric box or to first contact your box manufacturer.

#### **Pump prohibition:**

Connect the Pump prohibition terminal block to terminal block A1 on the filtration contact

- **A:** existing wires in the filtration box
- **B:** filtration contact installed in the box
- **C:** wire to add to connect the pump prohibition to the box RNS-1, RNS-2 and NIVA 3 Module

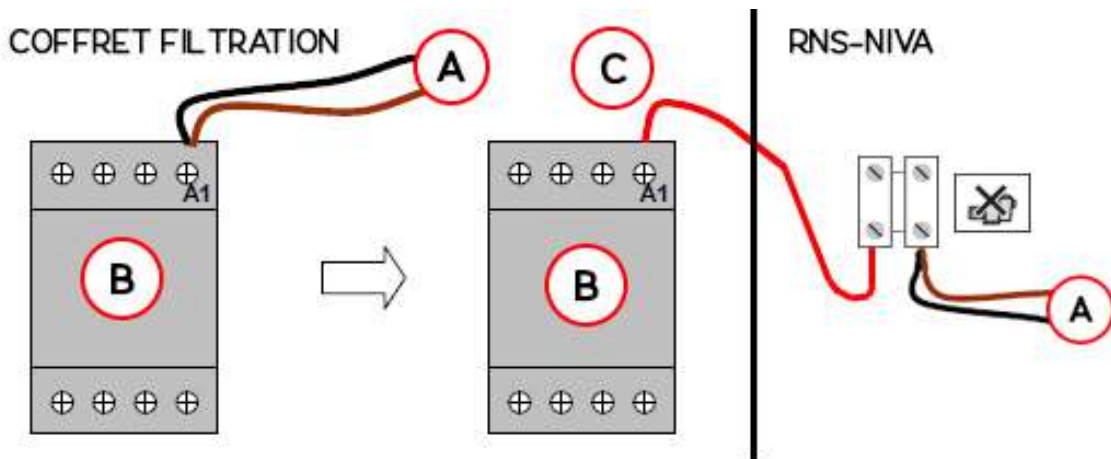

Disconnect the wire or wires arriving on the A1 terminal block from the filtration contact and send them to a terminal on the "Pump prohibition" screw terminal on the RNS-1, RNS-2 and NIVA 3 Module box. Then use another wire to connect the other "Pump prohibition" screw terminal to terminal A1 on the filtration contact.

## 4. Device operation - function description

### 4.1. Available features (depending on the version)

#### 4.1.1. Timer

In order to make the system insensitive to lapping water, the electronic system times level change detection. The system only opens the filling solenoid when the detected level remains below the threshold for 10 seconds.

Similarly, the solenoid will close when the level has stabilised over the threshold for 5 seconds.

#### 4.1.2. Pump prohibition output

The RNS-1, RNS-2 and NIVA 3 Module has a Pump prohibition output that is used to prevent the pump from running if there is not enough water.

#### 4.1.3. Filling solenoid output

Using this output, the RNS-1, RNS-2 and NIVA 3 Module sends alternating 24V when filling is required. Connect this output to the solenoid supplied with the module. When filling is active, the

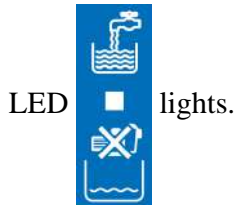

##### 4.1.3.1. Filling fault

If the high level is not reached after 3 hours, the box switches to monitoring mode for 30 minutes

and the indicator  lights orange (green + red LEDs). After 30 minutes, if the level has still not been reached, filling is cut and the pump prohibition remains active as a safety measure. The

indicator  switches to red.

In this situation, check the level sensor and the filling solenoid. Turn the device off and on again to reset the fault.

## 5. Installing the accessories

### 5.1. MFP-2 floater (RNS-1)

	<p>The MFP-2 floater is fixed in the skimmer. Preferably use silicone or neoprene adhesive and make sure not to block the removal of the filtering basket.</p> <p>A. Floater</p> <p>The device acts as an "on-off" switch. The floater height varies with the water level and when it is below the horizontal position (as in the photo for example), it activates filling and pump prohibition.</p> <p>Once the level has been reached, the device stops filling and restarts the filtration pump.</p>
-----------------------------------------------------------------------------------	---------------------------------------------------------------------------------------------------------------------------------------------------------------------------------------------------------------------------------------------------------------------------------------------------------------------------------------------------------------------------------------------------------------------------------------------------------------------------------------------------------

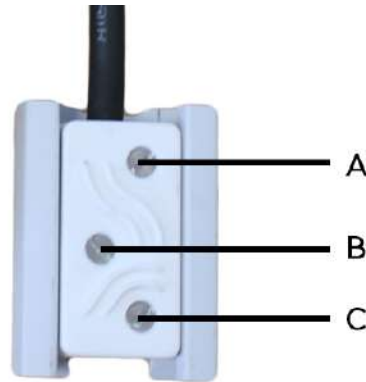

### 5.2. SE-3 sensor (RNS-2)

	<p>The SE-3 sensor is fixed in the skimmer. Preferably use silicone or neoprene adhesive.</p> <p>A. High level B. Low level C. Ref. level</p> <p>If the water level is above the high level (A), filtration is authorised and automatic filling is stopped.</p> <p>If the water level is below the low level (B), the device stops filtration (pump prohibition) and activates filling until the high level is reached (A).</p>
-------------------------------------------------------------------------------------	-----------------------------------------------------------------------------------------------------------------------------------------------------------------------------------------------------------------------------------------------------------------------------------------------------------------------------------------------------------------------------------------------------------------------------------------

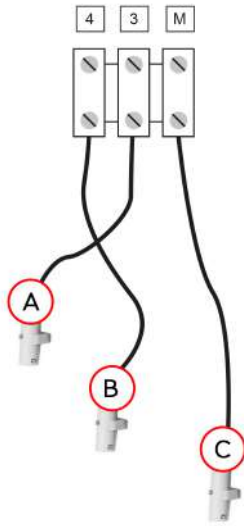
### 5.3. SE-1 sensors (Niva-3)

	<p>The 3 SE-3 sensors are placed in the skimmer, separately from each other. <b>We recommend</b> installing them in a channel or a PVC pipe to isolate them from the wall and keep them separate. The sensors must be fixed at the required height to prevent them from moving and avoid any pull on their wire. The sensor wires must be guided so that they do not tangle.</p> <p>A. High level (to connect to terminal 3)          B. Low level (to connect to terminal 4)          C. Ref. level (to connect to terminal M)</p> <p>If the water level is above the high level (A), filtration is authorised and automatic filling is stopped.</p> <p>If the water level is below the low level (B), the device stops filtration (pump prohibition) and activates filling until the high level is reached (A), or stops after 3 hours (see Fault section)</p>
-----------------------------------------------------------------------------------	--------------------------------------------------------------------------------------------------------------------------------------------------------------------------------------------------------------------------------------------------------------------------------------------------------------------------------------------------------------------------------------------------------------------------------------------------------------------------------------------------------------------------------------------------------------------------------------------------------------------------------------------------------------------------------------------------------------------------------------------------------------------------------------------------------------------------------------------------------------------------

## A. Declaration of conformity

<p>CCEI S.A.S (FR 47 40 35 21 693) declares that product RNS-1, RNS-2 and NIVA 3 Module is compliant with the safety and electromagnetic compatibility requirements of European directives E.M.C (2014/30/UE), Low voltage (2014/35/UE), RoHS (2011/65/UE), WEEE (2002/96/CE) and REACH (1907/2006).</p>		
		<p>Emmanuel Baret Marseille, on 02/01/2020</p>
<p><b>Distributor's stamp</b></p>		
<p><i>Date of sale:</i> ..... <i>Batch N°:</i> .....</p>		





NIVA 3



RNS 1-2

## RNS-1, RNS-2 und NIVA 3

Wasserstandregulierungsmodul

Réf : PF10L006 / PF10L002 / PF10L009

### Table des matières

1. Technische Daten .....	2
2. Verpackungsinhalt .....	3
3. Installation .....	3
3.1. Elektrischer Anschluss .....	3
4. Funktionsweise des Geräts - Beschreibung der Funktionen .....	6
4.1. Verfügbare Funktionen (je nach Version) .....	6
5. Installation des Zubehörs .....	7
5.1. Schwimmer MFP-2 (RNS-1) .....	7
5.2. Sonde SE-3 (RNS-2) .....	7
5.3. Sonden SE-1 (Niva-3) .....	8
<b>A. Konformitätserklärung .....</b>	<b>8</b>



**Diese Anweisung vor der Installation, Inbetriebnahme oder Benutzung dieses Produkts aufmerksam lesen.**

## 1. Technische Daten

Versorgungsspannung	230V AC - 50Hz
Gesamtabmessungen	220 x 200 x 150 mm
Schutzindex	IP-55
Füllstandsensoren	Je nach Modell: <ul style="list-style-type: none"><li>• 1 Schwimmer MFP2 (SF140008) = <b>RNS-1</b></li><li>• 1 Sonde SE-3 (SF140005) = <b>RNS-2</b></li><li>• 3 Sonden SE-1 (SF140017) = <b>NIVA-3</b></li></ul>
Ausgänge	1 Ausgang 24V AC - 6VA für Magnetventil 1 Ausgang potenzialfreier Kontakt zum Steuern der Pumpensperre



**Ausgang Zwangsbetrieb und entsprechende Kontrollleuchte**



**nicht aktiviert auf RNS-1, RNS-2 und NIVA 3**

## 2. Verpackungsinhalt

1 Box/ RNS-1, RNS-2 und NIVA 3	
1 Magnetventil 24V	1 Schmutzfänger (max. Druck 4 bar)
1 Füllstandsensor (je nach Modell unterschiedlich)	1 Betriebsanleitung (dieses Dokument)

## 3. Installation

### 3.1. Elektrischer Anschluss



Die Installation dieses Produkts kann Sie Stromschlägen aussetzen. Es wird empfohlen, eine qualifizierte Person hinzuzuziehen. Ein Installationsfehler, kann eine Gefährdung für Sie darstellen und das Produkt und die daran angeschlossenen Geräte unwiederbringlich schädigen.



Aus Sicherheitsgründen und entsprechend der Norm NF C15-100 muss der Schaltkasten, in dem das RNS-1, RNS-2 und NIVA 3 installiert ist,

- mehr als 3,50 m vom Poolrand entfernt angebracht werden, Beim Messen dieses Abstands wird die Umgehung von Hindernissen berücksichtigt. Wenn der Schaltkasten des RNS-1, RNS-2 und NIVA 3 hinter einer Mauer installiert wird, handelt es sich folglich um die Entfernung, die notwendig ist, um die Mauer zu umrunden und bis zum Schaltkasten zu gelangen.
- oder in einem in den Boden eingelassenen Bereich in unmittelbarer Umgebung des Pools, In diesem Fall muss der Bereich über eine Klappe zugänglich sein, für deren Öffnen ein Werkzeug erforderlich sein muss.
- hinter einem hochsensiblen Differentialschutz (30mA) gemäß der Norm NF C15-100.

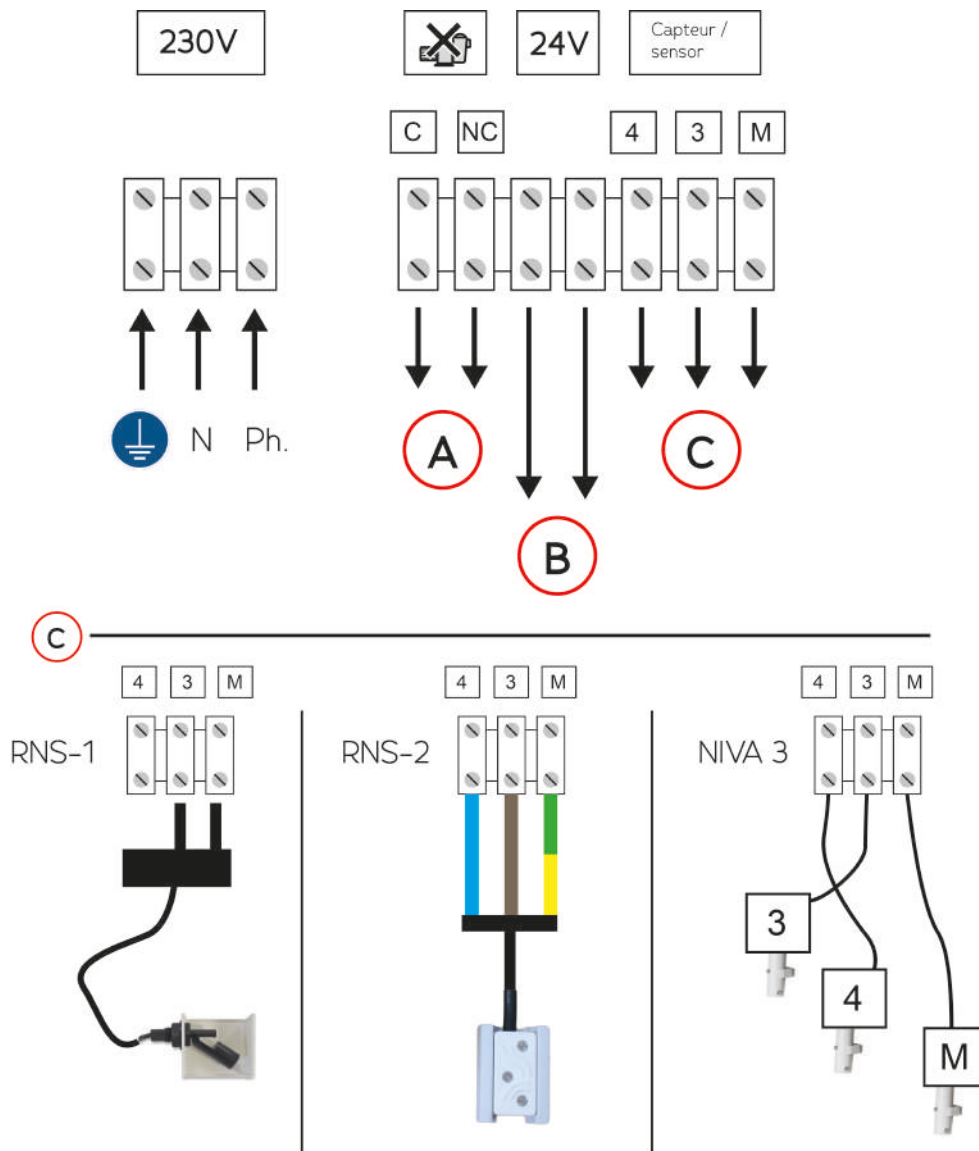

- A. Pumpensperre (Details unten)
- B. Ausgang 24V für Magnetventil
- C. Anschluss des mitgelieferten Füllstandsensors.

*Der Anschluss hängt vom verwendeten Füllstandsensor ab. Im unteren Teil des Bilds (C) werden die möglichen Anschlüsse beschrieben.*

### 3.1.1. Anschluss Pumpensperre

#### 3.1.1.1. Auf einem Schaltkasten der Marke CCEI

Die von CCEI hergestellten Schaltkästen sind mit einer vorverdrahteten ABCD-Klemmenleiste für die automatische Wasserstandsregulierung ausgestattet.

- **A und B:** Zwangsbetrieb der Filterpumpe (nicht benutzt bei RNS-1, RNS-2 und NIVA 3)
- **C und D:** Pumpensperre

In diesem Fall genügt es, den bestehenden "Shunt" zwischen C und D auf dem Filtergehäuse abzunehmen und die beiden, vom Ausgang "Pumpensperre" des RNS-1, RNS-2 und NIVA 3 kommenden Drähte daran anzuschließen.

#### 3.1.1.2. Bei einem Standard-Schaltkasten

Ist der Schaltkasten nicht für eine automatische Wasserstandsregulierung vorverdrahtet, erfolgt der Anschluss direkt am Filterschütz. Die Informationen haben ausschließlich Hinweisharakter. Befolgen Sie die Anweisungen der Bedienungsanleitung Ihres Pool-Schaltchranks oder kontaktieren Sie vorher den Hersteller des Schaltchranks.

#### **Pumpensperre:**

Schließen Sie die Klemmenleiste der Pumpensperre an der Klemme A1 des Filterschützes an

- **A:** im Filtergehäuse vorhandene Drähte
- **B:** im Schaltschrank installierter Filterschütz
- **C:** hinzuzufügender Draht zum Anschließen der Pumpensperre im Schaltkasten RNS-1, RNS-2 und NIVA 3

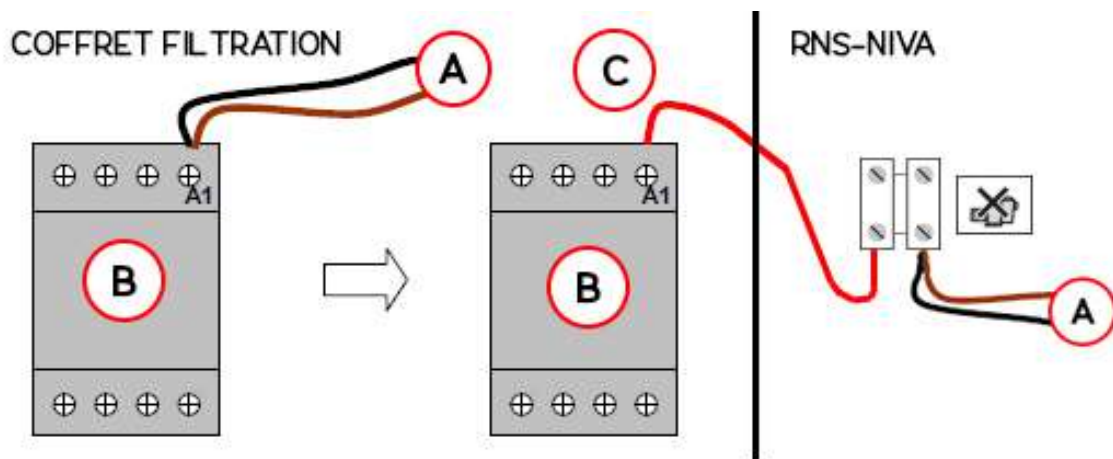

Den oder die zu Klemme A1 des Filterschützes führenden Drähte lösen und zu einem Anschluss der Lüsterklemme für die "Pumpensperre" der Box RNS-1, RNS-2 und NIVA 3 führen. Anschließend mit einem Draht den anderen Anschluss der Lüsterklemme der "Pumpensperre" an der Klemme A1 des Filterschützes anschließen.

## 4. Funktionsweise des Geräts - Beschreibung der Funktionen

### 4.1. Verfügbare Funktionen (je nach Version)

#### 4.1.1. Zeitverzögerung

Damit das System nicht auf Wellenschlag reagiert, verzögert die elektronische Vorrichtung die Detektion eines veränderten Wasserstands. Die Vorrichtung öffnet das Füllventil nur dann, wenn der erfasste Stand 10 Sekunden lang unterhalb des Grenzfüllstands bleibt.

Das Magnetventil schließt sich, wenn sich der Füllstand unterhalb des Grenzfüllstands 5 Sekunden lang stabilisiert hat.

#### 4.1.2. Ausgang Pumpensperre

RNS-1, RNS-2 und NIVA 3 verfügt über eine Pumpensperre, durch die vermieden wird, dass die Pumpe bei Wassermangel läuft.

#### 4.1.3. Ausgang Füllmagnetventil

An diesem Ausgang liefert RNS-1, RNS-2 und NIVA 3 24V Wechselstrom, wenn das Befüllen erforderlich ist. Verbinden Sie diesen Ausgang mit dem Magnetventil, das mit dem Modul mitge-

liefert wurde. Ist die Befüllung aktiviert, leuchtet die LED  auf.



##### 4.1.3.1. Fehler beim Befüllen

Wurde der hohe Wasserstand nach 3 Stunden nicht erreicht, schaltet das Gerät 30 Minuten lang auf den Überwachungsmodus um und die  Kontrollleuchte leuchtet Orange auf (LEDs Grün

+ Rot). Wurde nach weiteren 30 Minuten immer noch nicht der gewünschte Füllstand erreicht, wird die Befüllung unterbrochen und die Pumpensperre bleibt aus Sicherheitsgründen aktiviert. Die

Kontrollleuchte  leuchtet Rot auf.

In diesem Fall sind der Füllstandsensord und das Füllmagnetventil zu überprüfen. Um die Fehlermeldung zu deaktivieren, das Gerät aus- und wieder anschalten.

## 5. Installation des Zubehörs

### 5.1. Schwimmer MFP-2 (RNS-1)

	<p>Der Schwimmer MFP-2 wird im Skimmer befestigt. Vorzugsweise Silikon- oder Neoprenkleber benutzen und darauf achten, dass der Ausgang des Filterkorbs nicht verschlossen wird.</p> <p>A. Schwimmer</p> <p>Das Gerät agiert nach dem Auf/Zu-Prinzip. Die Höhe des Schwimmers hängt vom Wasserstand ab. Liegt dieser unter der horizontalen Position (wie z.B. auf dem Foto gezeigt), werden Befüllung und Pumpensperre aktiviert.</p> <p>Wurde der gewünschte Wasserstand erreicht, stoppt das Gerät die Befüllung und setzt die Filterpumpe wieder in Betrieb.</p>
-----------------------------------------------------------------------------------	----------------------------------------------------------------------------------------------------------------------------------------------------------------------------------------------------------------------------------------------------------------------------------------------------------------------------------------------------------------------------------------------------------------------------------------------------------------------------------------------------------------------------------------------------------------------

### 5.2. Sonde SE-3 (RNS-2)

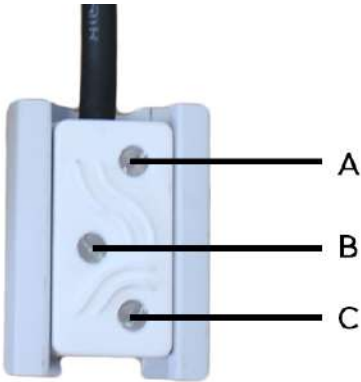
	<p>Die Sonde SE-3 wird im Skimmer befestigt. Vorzugsweise Silikon- oder Neoprenkleber benutzen.</p> <p>A. Hoher Stand B. Niedriger Stand C. Bezugsstand</p> <p>Steht das Wasser über dem oberen Füllstand (A), wird die Filterung freigegeben und die automatische Befüllung gestoppt.</p> <p>Steht das Wasser unter dem unteren Füllstand (B), stoppt das Gerät die Filterung (Pumpensperre) und aktiviert die Befüllung, bis der hohe Wasserstand (A) erreicht ist.</p>
-------------------------------------------------------------------------------------	-----------------------------------------------------------------------------------------------------------------------------------------------------------------------------------------------------------------------------------------------------------------------------------------------------------------------------------------------------------------------------------------------------------------------------------------------------------------------------------

### 5.3. Sonden SE-1 (Niva-3)

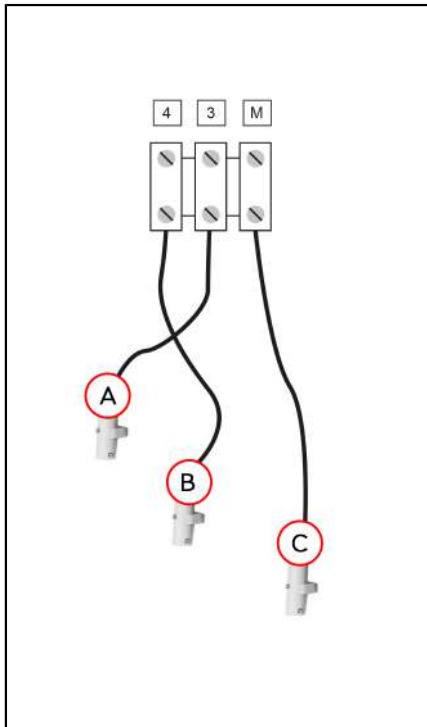

Die 3 Sonden SE-3 werden zueinander beabstandet in den Skimmer eingesetzt. **Wir empfehlen**, sie in eine Rinne oder ein PVC--Rohr einzusetzen, um sie von der Wand zu isolieren und voneinander zu trennen. Die Sonden sind in der angegebenen Höhe zu befestigen, damit sie sich nicht bewegen und keine Zugkraft auf ihren Draht ausgeübt wird. Die Drähte der Sonden müssen so geführt werden, dass sie sich nicht verheddern.

- A. Hoher Stand (Anschluss an Klemme 3)
- B. Niedriger Stand (Anschluss an Klemme 4)
- C. Bezugsstand (Anschluss an Klemme M)

Steht das Wasser über dem oberen Füllstand (A), wird die Filterung freigegeben und die automatische Befüllung gestoppt.

Steht das Wasser unter dem unteren Füllstand (B), stoppt das Gerät die Filterung (Pumpensperre) und aktiviert die Befüllung, bis der hohe Wasserstand (A) erreicht ist, oder schaltet sich nach 3 Stunden aus (siehe Abschnitt Fehler beim Befüllen)

## A. Konformitätserklärung

Die Gesellschaft CCEI S.A.S (FR 47 40 35 21 693) mit Sitz in 21, rue Antoine et Henri Maurras, 13016 Marseille, erklärt, dass das Produkt RNS-1, RNS-2 und NIVA 3 den Anforderungen an Sicherheit und elektromagnetischer Kompatibilität der europäischen Richtlinien C.E.M (2014/30/UE), Niederspannungen (2014/35/UE), RoHS (2014/65/UE), WEEE (2002/96/CE) und REACH (1907/2006) erfüllt.



Emmanuel Baret  
Marseille, am 02/01/2020

**Stempel Händler**

Verkaufsdatum: ..... Chargennr.: .....





NIVA 3



RNS 1-2

## RNS-1, RNS-2 en NIVA 3

Instelbare voor niveauregeling

Réf : PF10L006 / PF10L002 / PF10L009

### Table des matières

1. Technische eigenschappen .....	2
2. Inhoud van de verpakking .....	3
3. Installatie .....	3
3.1. Elektrische aansluiting .....	3
4. Werking van het apparaat - beschrijving van de functies .....	6
4.1. Beschikbare functies (volgens model) .....	6
5. Installatie van accessoires .....	7
5.1. Vlotter MFP-2 (RNS-1) .....	7
5.2. Sonde SE-3 (RNS-2) .....	7
5.3. Sondes SE-1 (Niva-3) .....	8
<b>A. Conformiteitsverklaring .....</b>	<b>8</b>



**Lees aandachtig deze handleiding vooraleer u dit product installeert, in werking stelt of in gebruik neemt.**

## 1. Technische eigenschappen

Voedingsspanning	230V AC - 50Hz
Totale afmetingen	220 x 200 x 150 mm
Beschermingsindex	IP-55
niveausensor	Volgens model: <ul style="list-style-type: none"><li>• 1 vlotter MFP2 (SF140008) = <b>RNS-1</b></li><li>• 1 sonde SE-3 (SF140005) = <b>RNS-2</b></li><li>• 3 sondes SE-1 (SF140017) = <b>NIVA-3</b></li></ul>
Uitgangen	1 uitgang 24V AC - 6VA voor magneetventiel 1 uitgang potentiaalvrij contact om de pompblokkering aan te sturen



**Uitgang geforceerde werking en het verklikkerlampje**  
**RNS-1, RNS-2 en NIVA 3**



**non-actief op**

## 2. Inhoud van de verpakking

1 RNS-1, RNS-2 en NIVA 3	1 zeefilter (max. druk 4 bar)
1 magneetventiel 24 V	1 Technische handleiding (onderhavig document)
1 niveausensor (verschilt naargelang model)	

## 3. Installatie

### 3.1. Elektrische aansluiting



De installatie van dit product kan u blootstellen aan elektrische schokken. Het wordt sterk aangeraden om beroep te doen op een gekwalificeerde persoon. Een installatiefout kan u in gevaar brengen en leiden tot onherstelbare schade aan het product en de aangesloten apparatuur.



De kast waarin de RNS-1, RNS-2 en NIVA 3 is geïnstalleerd, moet om veiligheidsredenen en in overeenstemming met de norm NF C15-100,

- worden geïnstalleerd, dit betekent op meer dan 3,5 m van het zwembad. Houd rekening met eventuele obstakels bij het meten van deze afstand. Als de kast van de RNS-1, RNS-2 en NIVA 3 achter een muur is geïnstalleerd, dan betreft het dus de afstand die nodig is om de omweg te doen en de kast te bereiken.
- hetzij in een ingegraven ruimte dicht bij het zwembad worden geïnstalleerd. In dit geval moet de ruimte toegankelijk zijn via een deksel die geopend wordt met een hulpmiddel.
- na een hoogsensitieve differentiaalbeveiliging (30mA) volgens de norm NF C15-100

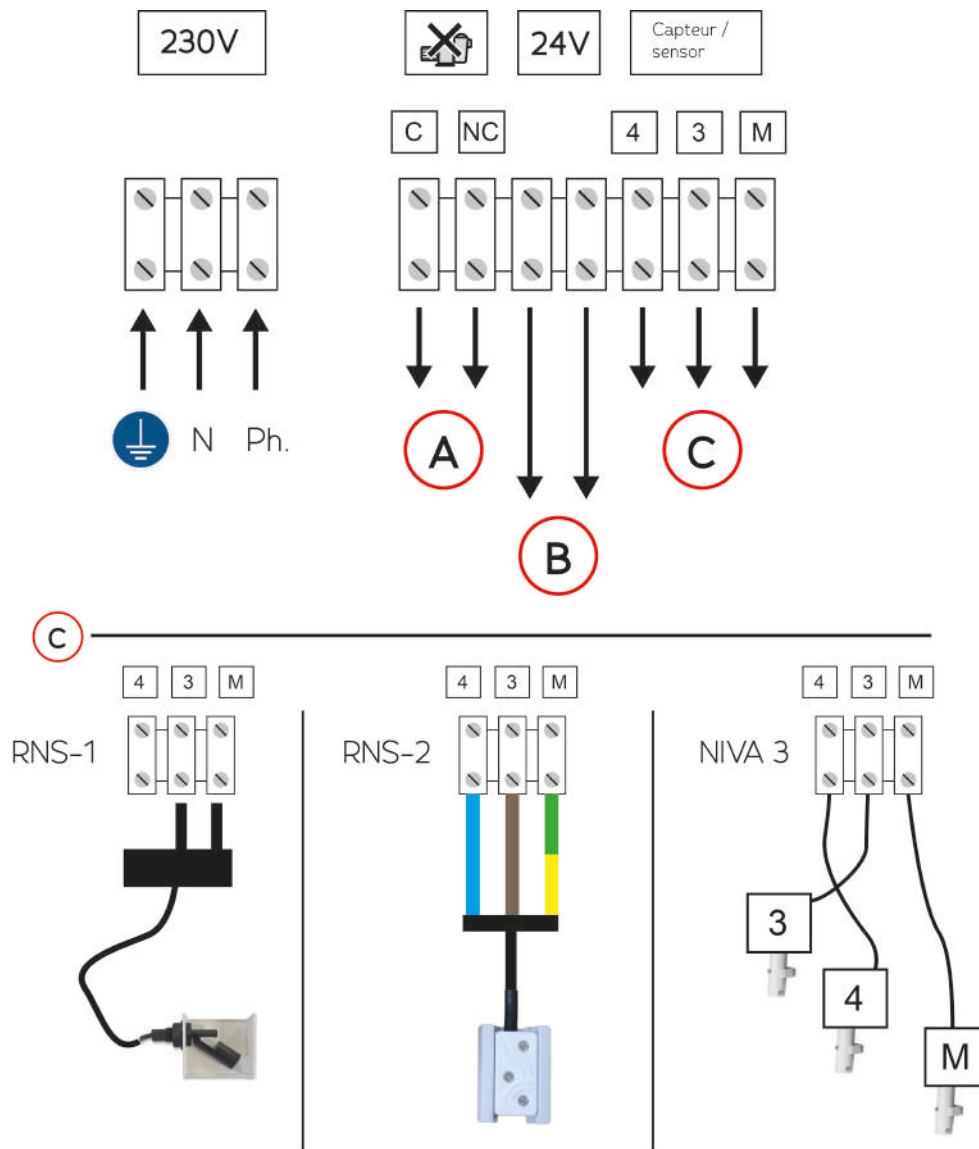

- A. Pompblokkering: (zie hieronder voor meer details)
- B. 24V-uitgang voor magneetventiel
- C. Aansluiting van de niveausensor die bij de elektrische doos werd geleverd.

*De aansluiting kan verschillen afhankelijk van de gebruikte niveausensor. Het onderste deel van de afbeelding (C) beschrijft de mogelijke aansluitingen.*

### 3.1.1. Aansluiting pompblokkering

#### 3.1.1.1. Op een elektrische doos van het merk CCEI

De door CCEI geproduceerde elektrische dozen zijn voorzien van een vooraf aangesloten aansluitblok, gemarkeerd met ABCD voor automatische niveaubesturing.

- **A en B:** geforceerde werking van de filterpomp (niet van toepassing op RNS-1, RNS-2 en NIVA 3)
- C en D: pompblokkering

Het enige wat u dan nog hoeft te doen is de "shunt" tussen C en D op de filtereenheid te verwijderen en in plaats daarvan de 2 draden aan te sluiten die uit de uitgang "pompblokkering" van de kast van de RNS-1, RNS-2 en NIVA 3.

#### 3.1.1.2. Op een standaard elektrische doos

Als de elektrische kast niet is uitgerust met een automatische niveauregeling, moeten de filterschakelaar . De volgende informatie wordt enkel ter informatie gegeven en het is absoluut noodzakelijk dat u de instructies voor uw elektrische kast voor het zwembad opvolgt of dat u vooraf contact opneemt met de fabrikant van uw kast.

#### **Pompblokkering:**

Sluit het klem pompblokkering aan op klem A1 van het filtratieschakelaar

- A: bestaande draden in de filterkast
- B: filtratieschakelaar geïnstalleerd in de doos
- C: draad die moet worden toegevoegd om de pompblokkering aan te sluiten op de doos RNS-1, RNS-2 en NIVA 3

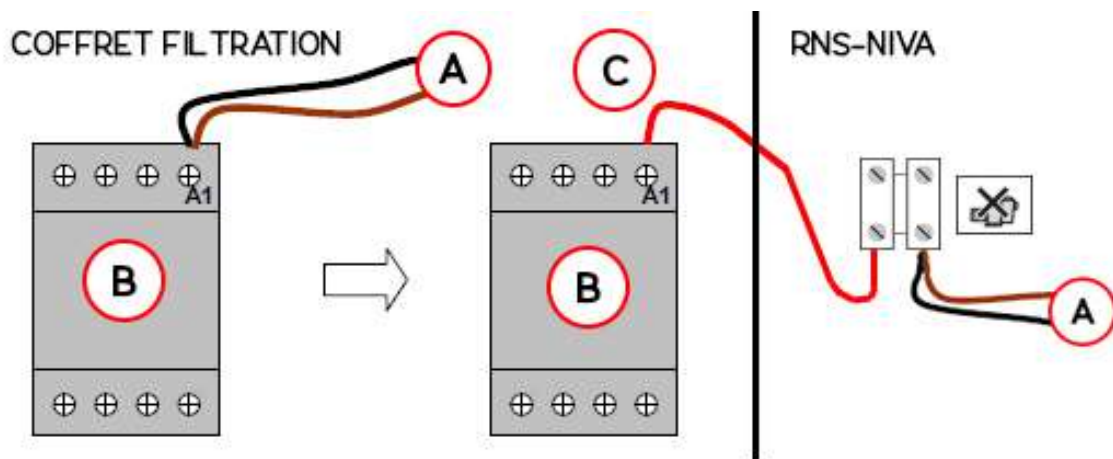

Maak de draad/draden die naar klem A1 van de filtratieschakelaar komt/komen los en leid die naar een klem op de "Pompblokkering"-kroonsteen op de doos van de RNS-1, RNS-2 en NIVA 3. Sluit vervolgens een draad van de de "Pompblokkering"-kroonsteen aan op de A1-klem van de filtratieschakelaar.

## 4. Werking van het apparaat - beschrijving van de functies

### 4.1. Beschikbare functies (volgens model)

#### 4.1.1. Timer

Om het systeem ongevoelig te maken voor woelig water, vertraagt het elektronische apparaat de detectie van een niveauwijziging. Het apparaat opent dus pas het magnetische vulventiel als het gedetecteerde niveau gedurende 10 seconden onder de drempelwaarde blijft.

Zo zal het magneetventiel ook pas sluiten als het niveau gedurende 5 seconden boven de drempelwaarde blijft.

#### 4.1.2. Uitgang pompblokkering

De RNS-1, RNS-2 en NIVA 3 is voorzien van een uitgang voor pompblokkering om te voorkomen dat de pomp draait als er niet voldoende water is.

#### 4.1.3. Uitgang magnetisch vulventiel

Via deze uitgang stuurt de RNS-1, RNS-2 en NIVA 3 24V AC wanneer er moet worden bijgevuld. Sluit deze uitgang aan op het magneetventiel dat met de module wordt meegeleverd. Wanneer er

water wordt bijgevuld, zal de LED  oplichten.



##### 4.1.3.1. Vulfout

Als het hoge niveau na 3 uur niet wordt bereikt, gaat het apparaat gedurende 30 minuten in bewa-

kingsmodus en  brandt het verklikkerlampje oranje (groene + rode leds). Als het niveau na 30 minuten nog steeds niet is bereikt, wordt het vullen gestopt en blijft de pompblokkering actief om

veiligheidsredenen. Het verklikkerlampje  licht dan rood op.

De niveausensor en het magnetische vulventiel moeten dan worden gecontroleerd. Om de storing te verhelpen moet het apparaat uit- en weer ingeschakeld worden.

## 5. Installatie van accessoires

### 5.1. Vlotter MFP-2 (RNS-1)

	<p>De MFP-2 vlotter wordt in een skimmer gemonteerd. Gebruik bij voorkeur siliconen- of neopreenlijm en zorg ervoor dat de uitgang van de filterkorf niet wordt geblokkeerd.</p> <p>A. Vlotter</p> <p>Het apparaat werkt als een "alles-of-niets"-apparaat. De hoogte van de vlotter varieert in functie van het waterniveau en wanneer de vlotter zich onder de horizontale positie bevindt (bijv. zoals op de foto). Deze activeert het vullen en de pompblokkering.</p> <p>Zodra het waterniveau is bereikt, stopt het apparaat met vullen en wordt de filterpomp opnieuw gestart.</p>
-----------------------------------------------------------------------------------	-------------------------------------------------------------------------------------------------------------------------------------------------------------------------------------------------------------------------------------------------------------------------------------------------------------------------------------------------------------------------------------------------------------------------------------------------------------------------------------------------------------------------------------------------------------------------------------------

### 5.2. Sonde SE-3 (RNS-2)

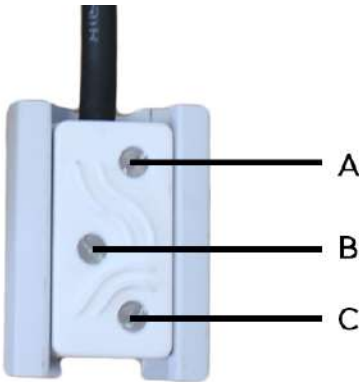
	<p>De SE-3-sonde wordt in de skimmer gemonteerd. Gebruik bij voorkeur siliconen- of neopreenlijm.</p> <p>A. Hoog niveau B. Laag niveau C. Referentieniveau</p> <p>Als het waterniveau boven het hoge waterniveau (A) ligt, stopt het apparaat met filteren en wordt het automatisch vullen gestopt.</p> <p>Als het waterniveau onder het lage waterniveau (B) ligt, stopt het apparaat met filteren (pompblokkering) en wordt het vullen geactiveerd totdat het hoge waterniveau (A) is bereikt.</p>
-------------------------------------------------------------------------------------	--------------------------------------------------------------------------------------------------------------------------------------------------------------------------------------------------------------------------------------------------------------------------------------------------------------------------------------------------------------------------------------------------------------------------------------------------------------------------------------------------------------

### 5.3. Sondes SE-1 (Niva-3)

	<p>De 3 SE-3-sensoren zijn in de skimmer geplaatst, iets van elkaar verwijderd. We raden aan om ze in een kanaal of pvc-buis te installeren om ze te isoleren van de wand en ze gescheiden te houden. De sondes moeten op de gewenste hoogte worden vastgemaakt om te voorkomen dat ze worden verplaatst en om trekbewegingen op hun kabel te vermijden. Sondedraden moeten zodanig worden geleid dat ze niet in de war raken.</p> <p>A. Hoog niveau (aansluiten op klem 3)          B. Laag niveau (aansluiten op klem 4)          C. Referentieniveau (aansluiten op klem M)</p> <p>Als het waterniveau boven het hoge waterniveau (A) ligt, stopt het apparaat met filteren en wordt het automatisch vullen gestopt.</p> <p>Als het waterniveau onder het lage waterniveau (B) ligt, stopt het apparaat met filteren (pompblokkering) en wordt het vullen geactiveerd totdat het hoge waterniveau (A) is bereikt, of stopt het vullen na 3 uur (zie paragraaf Fout)</p>
--	------------------------------------------------------------------------------------------------------------------------------------------------------------------------------------------------------------------------------------------------------------------------------------------------------------------------------------------------------------------------------------------------------------------------------------------------------------------------------------------------------------------------------------------------------------------------------------------------------------------------------------------------------------------------------------------------------------------------------------------------------------------------------------------------------------------------------------------------------------------------------------------------------------------------------------------------------------------------------------

## A. Conformiteitsverklaring

<p>De onderneming CCEI S.A.S (FR 47 40 35 21 693) verklaart dat het product RNS-1, RNS-2 en NIVA 3 voldoet aan de eisen van veiligheid en de elektromagnetische compatibiliteit van de Europese richtlijnen 2006/95/EG en 2004/108/EG.</p>		
		<p>Emmanuel Baret          Marseille, op 02/01/2020</p>
<p align="center"><b>Stempel van de distributeur</b></p>		
<p>Verkoopdatum ..... Partijnr.: .....</p>		





NIVA 3



RNS 1-2

## RNS-1, RNS-2 e NIVA 3

configurabile di regolazione del livello

Réf : PF10L006 / PF10L002 / PF10L009

### Table des matières

1. Caratteristiche tecniche .....	2
2. Contenuto della confezione .....	3
3. Installazione .....	3
3.1. Collegamento elettrico .....	3
4. Funzionamento dell'apparecchio - descrizione delle funzioni .....	6
4.1. Funzionalità disponibili (a seconda della versione) .....	6
5. Installazione degli accessori .....	7
5.1. Galleggiante MFP-2 (RNS-1) .....	7
5.2. Sonda SE-3 (RNS-2) .....	7
5.3. Sonde SE-1 (Niva-3) .....	8
<b>A. Dichiarazione di conformità .....</b>	<b>8</b>



**Leggere attentamente queste istruzioni prima dell'installazione, della messa in servizio o dell'utilizzo del presente prodotto.**

## 1. Caratteristiche tecniche

Tensione di alimentazione	230V AC - 50 Hz
Dimensioni complessive	220 x 200 x 150 mm
Indice di protezione	IP-55
Sensore di livello	Secondo modello: <ul style="list-style-type: none"><li>• 1 galleggiante MFP2 (SF140008) = <b>RNS-1</b></li><li>• 1 sonda SE-3 (SF140005) = <b>RNS-2</b></li><li>• 3 sonde SE-1 (SF140017) = <b>NIVA-3</b></li></ul>
Uscite	1 uscita 24 V AC - 6 VA per elettrovalvola 1 uscita contatto a secco per gestire l'inibitore della pompa



**Uscita funzionamento forzato e relativa spia**  **non attivi su RNS-1, RNS-2 e NIVA 3**

## 2. Contenuto della confezione

1 scatola RNS-1, RNS-2 e NIVA 3	1 filtro a setaccio (pressione max 4 bar)
1 elettrovalvola 24V	1 fascicolo di Informazioni tecniche (il presente documento)
1 sensore di livello (diverso a seconda del modello)	

## 3. Installazione

### 3.1. Collegamento elettrico



L'installazione di questo prodotto può esporvi a shock elettrici. Si raccomanda vivamente di chiedere l'aiuto di un tecnico qualificato. Un errore di installazione può mettervi in pericolo e danneggiare in maniera irreversibile il prodotto e le attrezzature ad esso collegate.



Per ragioni di sicurezza e conformemente alla normativa NF C15-100, la scatola nella quale è installato il RNS-1, RNS-2 e NIVA 3 deve essere installata

- a più di 3,5 m dal bordo della piscina. Questa distanza viene calcolata tenendo conto dell'aggiramento degli ostacoli. Se la scatola del RNS-1, RNS-2 e NIVA 3 viene installata dietro un muro, la distanza calcolata è quella necessaria per fare il giro e raggiungere la scatola.
- oppure in un locale interrato nelle immediate vicinanze della piscina. In questo caso, il locale deve essere accessibile con una botola che necessita di uno strumento per essere aperta.
- oltre a una protezione differenziale ad alta sensibilità (30 mA) conformemente alla normativa NF C15-100.

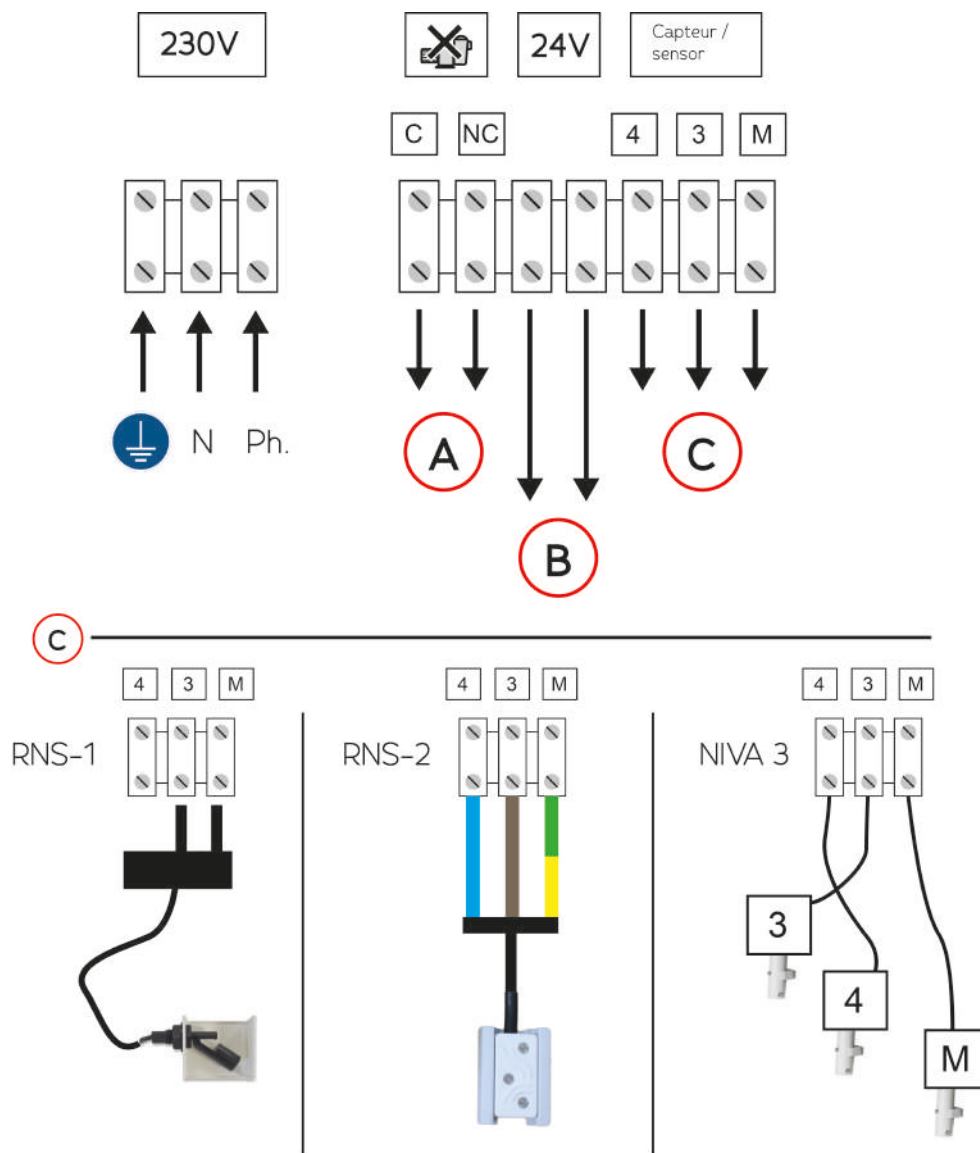

- A. Inibitore pompa (vedere oltre per maggiori dettagli)
- B. Uscita 24 V per elettrovalvola
- C. Collegamento del sensore di livello fornito con la scatola.

*A seconda del sensore di livello utilizzato, il collegamento è diverso. La parte inferiore dell'immagine (C) descrive i possibili collegamenti.*

### 3.1.1. Collegamento inibitore pompa

#### 3.1.1.1. Su una scatola elettrica a marchio CCEI

Le scatole elettriche prodotte da CCEI sono dotate di una morsettiera pre-collegata, contrassegnata ABCD, per le regolazioni automatiche del livello.

- **A e B:** funzionamento forzato della pompa di filtraggio (non utilizzato per i RNS-1, RNS-2 e NIVA 3)
- **C e D:** inibitore pompa

Basta quindi rimuovere lo "shunt" esistente tra C e D sull'unità di filtraggio e collegare invece i 2 fili provenienti dall'uscita "Inibitore pompa" della scatola RNS-1, RNS-2 e NIVA 3.

#### 3.1.1.2. Su una scatola elettrica standard

Se la scatola elettrica non è predisposta per la regolazione automatica del livello, bisogna collegarsi direttamente all'interruttore di filtraggio e al. Le seguenti informazioni sono fornite a titolo puramente indicativo ed è assolutamente necessario seguire le istruzioni della propria scatola elettrica della piscina o contattare preventivamente il produttore della stessa.

##### **Inibitore pompa:**

collegare la morsettiera dell'inibitore pompa al morsetto A1 dell'interruttore di filtraggio

- **A:** fili esistenti nella scatola di filtraggio
- **B:** interruttore di filtraggio installato nella scatola
- **C:** filo da aggiungere per collegare l'inibitore della pompa alla scatola RNS-1, RNS-2 e NIVA 3

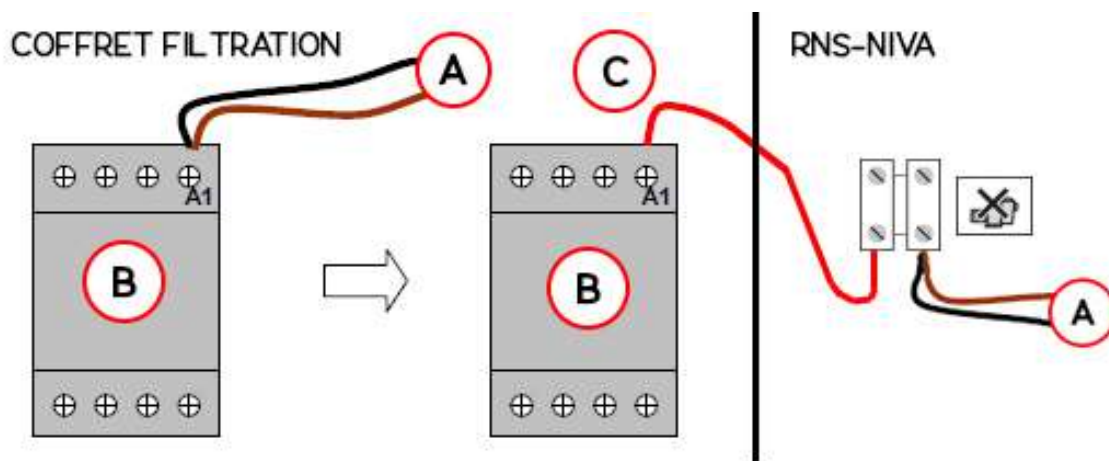

Scollegare il/i filo/i in ingresso sul morsetto A1 dell'interruttore di filtraggio, spostandolo/i su un morsetto del connettore domino "Inibitore pompa" della scatola RNS-1, RNS-2 e NIVA 3. Quindi collegare con un filo l'altro morsetto del connettore domino "Inibitore pompa" al morsetto A1 dell'interruttore di filtraggio.

## 4. Funzionamento dell'apparecchio - descrizione delle funzioni

### 4.1. Funzionalità disponibili (a seconda della versione)

#### 4.1.1. Temporizzazione

Per rendere il sistema insensibile allo sciabordio, il dispositivo elettronico temporizza il rilevamento del cambio di livello. In questo modo il dispositivo apre l'elettrovalvola di riempimento solo quando il livello rilevato rimane al di sotto del livello di soglia per 10 secondi.

Allo stesso modo, l'elettrovalvola si chiuderà solo quando il livello si sarà stabilizzato sopra la soglia per 5 secondi.



#### 4.1.2. Uscita inibitore pompa

Il RNS-1, RNS-2 e NIVA 3 ha un'uscita Inibitore Pompa per evitare che la pompa funzioni in una situazione di carenza d'acqua.

#### 4.1.3. Uscita elettrovalvola di riempimento

Su questa uscita, il RNS-1, RNS-2 e NIVA 3 invia 24 V di corrente alternata quando è richiesto il riempimento. Collegare questa uscita all'elettrovalvola fornita con il modulo. Quando il riempimento è attivo, il LED  si illumina.

##### 4.1.3.1. Anomalia di riempimento

Se dopo 3 ore non è stato raggiunto il livello alto, la scatola entra in modalità di monitoraggio per 30 minuti e la spia  si illumina di arancione (LED verdi + rossi). Trascorsi 30 minuti, se il livello non è stato ancora raggiunto, il riempimento viene interrotto e l'inibitore della pompa rimane attivato per motivi di sicurezza. La spia  si illumina poi di rosso.

A quel punto è necessario controllare il sensore di livello e l'elettrovalvola di riempimento. Per risolvere l'anomalia, bisogna spegnere e riaccendere l'apparecchio.

## 5. Installazione degli accessori

### 5.1. Galleggiante MFP-2 (RNS-1)

	<p>Il galleggiante MFP-2 va fissato nello skimmer. Utilizzare preferibilmente colla siliconica o neoprene e fare attenzione a non ostruire l'uscita del cestello filtrante.</p> <p>A. Galleggiante</p> <p>Il dispositivo è di tipo "tutto o niente". L'altezza del galleggiante varia a seconda del livello dell'acqua e quando il galleggiante si trova al di sotto della posizione orizzontale (come ad esempio nella foto), attiva il riempimento e l'inibitore pompa.</p> <p>Una volta raggiunto il livello dell'acqua, l'unità interrompe il riempimento e riattiva la pompa di filtraggio.</p>
-----------------------------------------------------------------------------------	------------------------------------------------------------------------------------------------------------------------------------------------------------------------------------------------------------------------------------------------------------------------------------------------------------------------------------------------------------------------------------------------------------------------------------------------------------------------------------------------------------------------------------------------------------------------------------------------------

### 5.2. Sonda SE-3 (RNS-2)

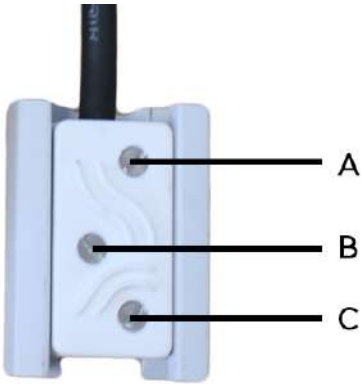
	<p>La sonda SE-3 va fissata nello skimmer. Utilizzare preferibilmente colla siliconica o neoprene.</p> <p>A. Livello alto B. Livello basso C. Livello di rif.</p> <p>Se il livello dell'acqua è superiore al livello alto (A), è possibile il filtraggio e il riempimento automatico viene interrotto.</p> <p>Se il livello dell'acqua si trova al di sotto del livello basso (B), l'unità interrompe il filtraggio (inibitore pompa) e attiva il riempimento fino al raggiungimento del livello alto (A).</p>
-------------------------------------------------------------------------------------	------------------------------------------------------------------------------------------------------------------------------------------------------------------------------------------------------------------------------------------------------------------------------------------------------------------------------------------------------------------------------------------------------------------------------------------------------------------------------------------------------------------------

### 5.3. Sonde SE-1 (Niva-3)

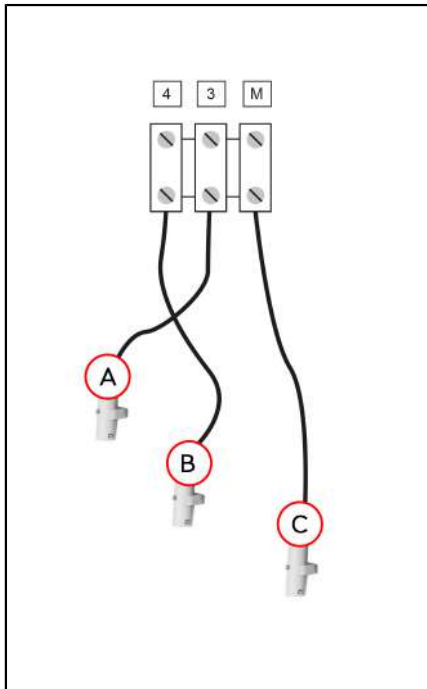



Le 3 sonde SE-3 sono posizionate nello skimmer, lontane le une dalle altre. **Si consiglia** di installarle in un condotto o in un tubo in PVC per isolarle dalla parete e tenerle separate. Le sonde devono essere fissate alla giusta altezza per impedirne il movimento e per evitare qualsiasi trazione al loro filo. I fili delle sonde devono essere guidati in modo da evitare grovigli.

A. Livello alto (da collegare al morsetto 3)  
 B. Livello basso (da collegare al morsetto 4)  
 C. Livello di rif. (da collegare al morsetto M)

Se il livello dell'acqua è inferiore al livello alto (A), è possibile il filtraggio e il riempimento automatico viene interrotto.

Se il livello dell'acqua si trova al di sotto del livello basso (B), l'unità interrompe il filtraggio (inibitore pompa) e attiva il riempimento fino al raggiungimento del livello alto (A), oppure lo interrompe trascorse 3 ore (vedere paragrafo Anomalia)

### A. Dichiarazione di conformità

<p>La società CCEI S.A.S (FR 47 40 35 21 693) dichiara che il prodotto RNS-1, RNS-2 e NIVA 3 soddisfa inoltre i requisiti di sicurezza e di compatibilità elettromagnetica delle direttive europee C.E.M (2014/30/UE), bassa tensione (2014/35/UE), RoHS (2011/65/UE), DEEE (2002/96/CE) e REACH (1907/2006).</p>		
		<p>Emmanuel Baret Marseille, il 02/01/2020</p>
<p><b>Timbro del Distributore</b></p>		
<p>Data di vendita: ..... N. del lotto: .....</p>		





# Instrucciones de Uso



NIVA 3



RNS 1-2

## RNS-1, RNS-2 y NIVA 3

de regulación de nivel configurable

Réf : PF10L006 / PF10L002 / PF10L009

## Table des matières

1. Características técnicas .....	2
2. Contenido del embalaje .....	3
3. Instalación .....	3
3.1. Conexión eléctrica .....	3
4. Funcionamiento del aparato - descripción de las funciones .....	6
4.1. Funciones disponibles (según versión) .....	6
5. Instalación de accesorios .....	7
5.1. Flotador MFP-2 (RNS-1) .....	7
5.2. Sonda SE-3 (RNS-2) .....	7
5.3. Sondas SE-1 (Niva-3) .....	8
<b>A. Declaración de conformidad .....</b>	<b>8</b>



**Lea atentamente este manual antes de la instalación, de poner en marcha o de utilizar el producto.**

## 1. Características técnicas

Tensión de alimentación	230V AC - 50Hz
Dimensiones totales	220 x 200 x 150 mm
Índice de protección	IP-55
Sensor de nivel	Según modelo: <ul style="list-style-type: none"><li>• 1 flotador MFP2 (SF140008) = <b>RNS-1</b></li><li>• 1 sonda SE-3 (SF140005) = <b>RNS-2</b></li><li>• 3 sondas SE-1 (SF140017) = <b>NIVA-3</b></li></ul>
Salidas	1 salida 24V AC - 6VA para electroválvula 1 salida de contacto seco para gestionar la prohibición de bomba



**Salida de marcha forzada y piloto correspondiente**  **no activos en RNS-1, RNS-2 y NIVA 3**

## 2. Contenido del embalaje

1 caja RNS-1, RNS-2 y NIVA 3	1 filtro tamiz (presión máxima 4 bares)
1 electroválvula 24V	1 Manual técnico (este documento)
1 sensor de nivel (diferente según el modelo)	

## 3. Instalación

### 3.1. Conexión eléctrica



La instalación de este producto puede exponerle a choques eléctricos. Es muy recomendable que lo realice una persona cualificada. Un error de instalación puede ponerle en peligro y dañar de manera irreversible el producto y los equipamientos que van ligados.



Por razones de seguridad y conforme a la norma NF C15-100, la caja en la que está contenido el RNS-1, RNS-2 y NIVA 3 debe instalarse

- bien a una distancia máxima de 3m50 del borde de la piscina. Esta distancia incluye el tránsito alrededor de los obstáculos. Si la caja del RNS-1, RNS-2 y NIVA 3 está instalada en la parte trasera de una pared, hay que tener en cuenta la distancia necesaria para rodear la pared y llegar a la caja.
- bien en un compartimento enterrado a proximidad inmediata de la piscina. En este caso debe poder accederse al compartimento a través de una trampilla con la herramienta necesaria para abrirla.
- tras una protección diferencial de alta sensibilidad (30mA) según la norma NF C15-100

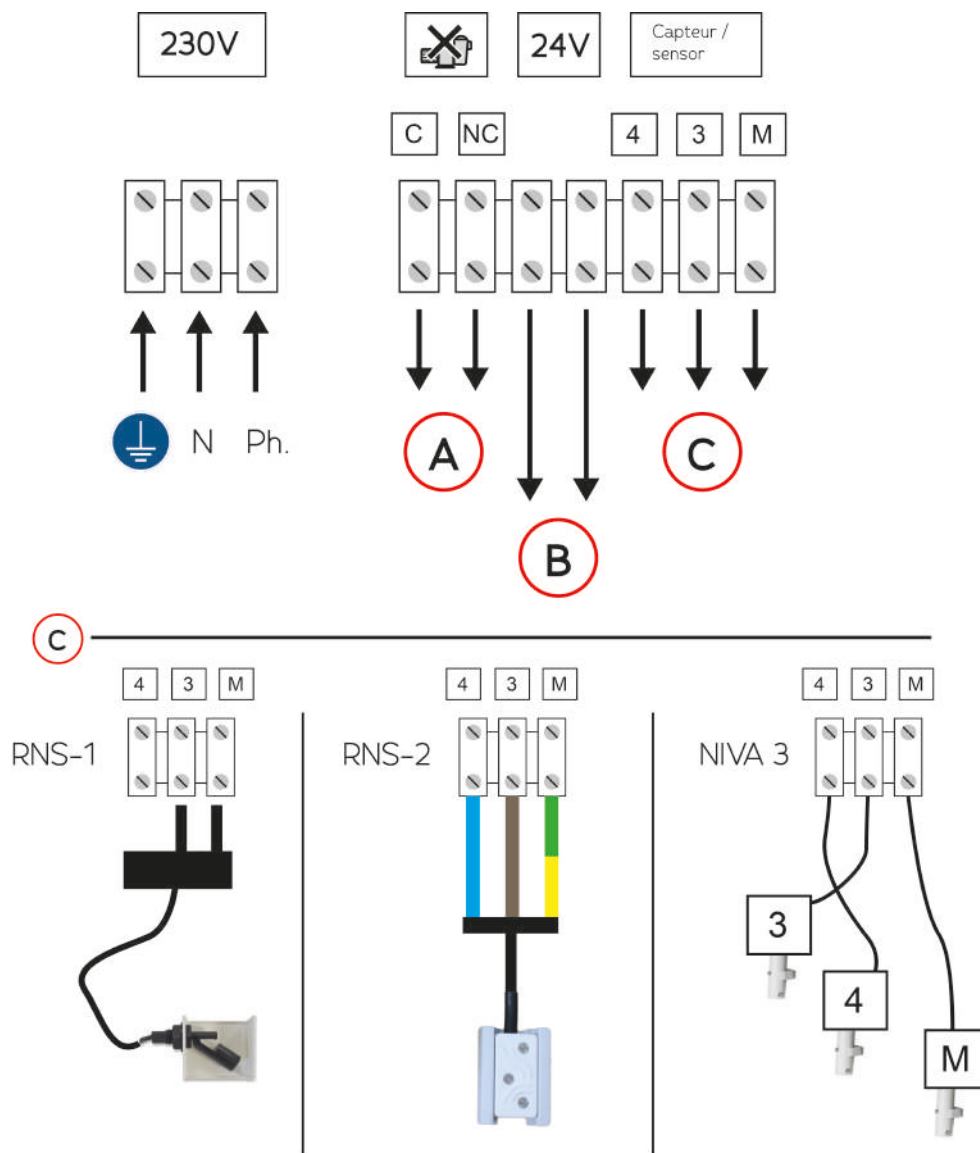

- A. Prohibición bomba (ver más abajo para más detalles)
- B. Salida de 24V para electroválvula
- C. Conexión del sensor de nivel suministrado con la caja.

*Según el sensor de nivel utilizado, la conexión es diferente. En la parte inferior de la imagen (C) se describen las conexiones posibles.*

### 3.1.1. Conexión prohibición bomba

#### 3.1.1.1. En una caja eléctrica de la marca CCEI

Las cajas eléctricas fabricadas por CCEI están equipadas con una regleta de terminales preconectada marcada ABCD para la regulación automática de nivel.

- **A y B:** marcha forzada de la bomba de filtración (no utilizada para los RNS-1, RNS-2 y NIVA 3)
- **C y D:** prohibición bomba

Basta con retirar la derivación existente entre C y D en la caja de filtración y conectar en su lugar los 2 cables procedentes de la salida "prohibición bomba" de la caja RNS-1, RNS-2 y NIVA 3.

#### 3.1.1.2. En una caja eléctrica estándar

Si la caja eléctrica no está preequipada para una regulación automática de nivel, la conexión se efectúa directamente al contactor de filtración. Las siguientes informaciones se proporcionan a título orientativo, por lo cual es imprescindible seguir las instrucciones de la caja eléctrica de su piscina o contactar previamente con el fabricante de su caja.

#### Prohibición bomba:

Conectar la regleta de terminales "prohibición bomba" al terminal A1 del contactor de filtración

- **A:** cables existentes en la caja de filtración
- **B:** contactor de filtración instalado en la caja
- **C:** cable que debe añadirse para conectar la prohibición bomba de la caja RNS-1, RNS-2 y NIVA 3

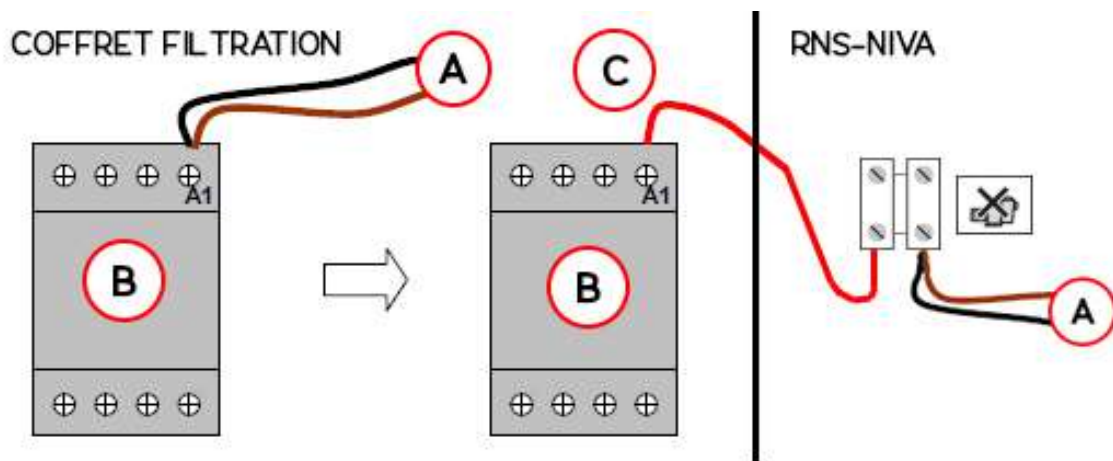

Desconectar el cable o cables que llegan al terminal A1 del contactor de filtración y enviarlos a un terminal de la regleta "prohibición bomba" de la caja RNS-1, RNS-2 y NIVA 3. Seguidamente, conectar con un cable el otro terminal de la regleta "prohibición bomba" al terminal A1 del contactor de filtración.

## 4. Funcionamiento del aparato - descripción de las funciones

### 4.1. Funciones disponibles (según versión)

#### 4.1.1. Temporización

Para que el sistema sea insensible a la agitación del agua, el dispositivo electrónico temporiza la detección de un cambio de nivel. De tal forma, el dispositivo solo abre la electroválvula de relleno cuando el nivel detectado permanece por debajo del nivel umbral durante 10 segundos.

Del mismo modo, la electroválvula solo se cerrará cuando el nivel se haya estabilizado por encima del umbral durante 5 segundos.

#### 4.1.2. Salida prohibición bomba

El RNS-1, RNS-2 y NIVA 3 dispone de una salida "prohibición bomba" que permite evitar que la bomba funcione con falta de agua.

#### 4.1.3. Salida electroválvula de relleno

En esta salida, el RNS-1, RNS-2 y NIVA 3 envía corriente alterna de 24V cuando se requiere el relleno. Conecte esta salida a la electroválvula suministrada con el módulo. Cuando el relleno está

activo, el LED  se enciende.



##### 4.1.3.1. Fallo de relleno

Si no se alcanza el nivel alto al cabo de 3 horas, la caja pasa a modo vigilancia durante 30 minutos

y el piloto  se enciende en color naranja (LEDs verdes + rojos). Al cabo de 30 minutos, si el

nivel no se ha alcanzado aún, el relleno se detiene y la prohibición bomba permanece activada por

seguridad. El piloto  se enciende entonces en color rojo.

Hay que controlar por tanto el sensor de nivel y la electroválvula de relleno. Para eliminar el fallo, el aparato debe apagarse y volver a encenderse.

## 5. Instalación de accesorios

### 5.1. Flotador MFP-2 (RNS-1)

	<p>El flotador MFP-2 se fija en un skimmer. Utilice preferentemente cola de silicona o neopreno y procure no obstruir la salida de la cesta filtrante.</p> <p>A. Flotador</p> <p>El aparato actúa como un dispositivo "todo o nada". La altura del flotador varía según el nivel del agua y cuando éste se encuentra por debajo de la posición horizontal (ver ejemplo en la foto), activa el relleno y la prohibición bomba</p> <p>Una vez alcanzado el nivel del agua, el aparato detiene el relleno y vuelve a poner en funcionamiento la bomba de filtración.</p>
-----------------------------------------------------------------------------------	-----------------------------------------------------------------------------------------------------------------------------------------------------------------------------------------------------------------------------------------------------------------------------------------------------------------------------------------------------------------------------------------------------------------------------------------------------------------------------------------------------------------------------------------------------------------------

### 5.2. Sonda SE-3 (RNS-2)

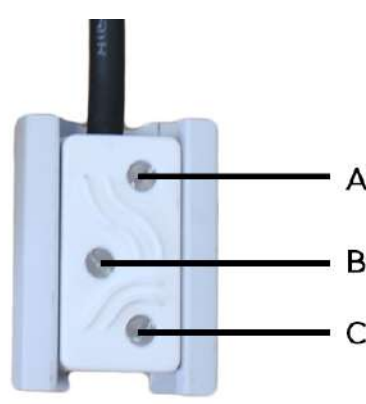
	<p>La sonda SE-3 se fija en el skimmer. Utilice preferiblemente cola de silicona o neopreno.</p> <p>A. Nivel alto B. Nivel bajo C. Nivel ref.</p> <p>Si el nivel del agua está por encima del nivel alto (A), se permite la filtración y se detiene el relleno automático.</p> <p>Si el nivel del agua está por debajo del nivel bajo (B), el aparato detiene la filtración (prohibición bomba) y activa el relleno hasta que se alcance el nivel alto (A).</p>
-------------------------------------------------------------------------------------	-------------------------------------------------------------------------------------------------------------------------------------------------------------------------------------------------------------------------------------------------------------------------------------------------------------------------------------------------------------------------------------------------------------------------------------------------------------------------

### 5.3. Sondas SE-1 (Niva-3)

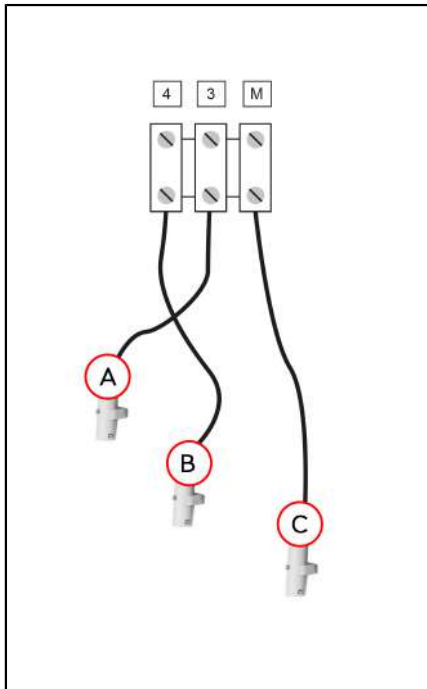



Las 3 sondas SE-3 se colocan en el skimmer, separadas entre sí. **Recomendamos** instalarlas en una canaleta o tubería de PVC para aislarlas de la pared y mantenerlas separadas. Las sondas deben fijarse a la altura requerida para impedir su movimiento y evitar cualquier tracción sobre su cable. Los cables de las sondas deben guiarse de manera que se evite que puedan enredarse.

- A. Nivel alto (para conectar al terminal 3)
- B. Nivel bajo (para conectar al terminal 4)
- C. Nivel ref. (para conectar al terminal M)

Si el nivel del agua está por encima del nivel alto (A), se permite la filtración y se detiene el relleno automático.

Si el nivel del agua está por debajo del nivel bajo (B), el aparato detiene la filtración (prohibición bomba) y activa el relleno hasta que se alcance el nivel alto (A), o lo detiene al cabo de 3 horas (ver apartado Fallos)

### A. Declaración de conformidad

<p>La empresa CCEI S.A.S (FR 47 40 35 21 693) declara que el producto RNS-1, RNS-2 y NIVA 3 cumple las exigencias de seguridad y compatibilidad electromagnética de las Directivas Europeas C.E.M (2014/30/UE), Baja Tensión (2014/35/UE), RoHS (2011/65/UE), DEEE (2002/96/CE) y REACH (1907/2006).</p>		
		<p>Emmanuel Baret Marseille, la 02/01/2020</p>
<p><b>Sello del Distribuidor</b></p>		
<p>Fecha de venta: ..... N° de lote: .....</p>		





NIVA 3



RNS 1-2

## RNS-1, RNS-2 e NIVA 3

de regulação de nível configurável

Réf : PF10L006 / PF10L002 / PF10L009

### Table des matières

1. Características técnicas .....	2
2. Conteúdo da embalagem .....	3
3. Instalação .....	3
3.1. Ligação elétrica .....	3
4. Funcionamento do aparelho - descrição das funções .....	6
4.1. Funcionalidades disponíveis (consoante versão) .....	6
5. Instalação dos acessórios .....	7
5.1. Flutuador MFP-2 (RNS-1) .....	7
5.2. Sonda SE-3 (RNS-2) .....	7
5.3. Sondas SE-1 (Niva-3) .....	8
<b>A. Declaração de conformidade .....</b>	<b>8</b>



**Ler atentamente este manual antes de instalar, colocar em funcionamento ou utilizar este produto.**

**O projetor nunca deve ser alimentado fora de água.**

**Utilizar preferencialmente o transformador de segurança**

## 1. Características técnicas

Tensão de alimentação	230V AC - 50Hz
Dimensões totais	220 x 200 x 150 mm
Índice de proteção	IP-55
Sensor de nível	Consoante o modelo: <ul style="list-style-type: none"><li>• 1 flutuador MFP2 (SF140008) = <b>RNS-1</b></li><li>• 1 sonda SE-3 (SF140005) = <b>RNS-2</b></li><li>• 3 sondas SE-1 (SF140017) = <b>NIVA-3</b></li></ul>
Saídas	1 saída 24V AC - 6VA para eletroválvula 1 saída contacto seco para gerir a interdição bomba



**Saída marcha forçada e indicador luminoso correspondente em RNS-1, RNS-2 e NIVA 3**



**não ativos**

## 2. Conteúdo da embalagem

1 caixa RNS-1, RNS-2 e NIVA 3	1 filtro tremonha (pressão máx. 4 bar)
1 eletroválvula 24V	1 Manual técnico (este documento)
1 sensor de nível (diferente consoante modelo)	

## 3. Instalação

### 3.1. Ligação elétrica



A instalação deste produto pode expô-lo a choques elétricos. Recomenda-se vivamente recorrer a uma pessoa qualificada. Um erro na instalação pode colocá-lo em perigo e danificar de forma irreversível o produto e os equipamentos que estão ligados a este.



Por motivos de segurança e em conformidade com a norma NF C15-100, o quadro no qual está instalado o RNS-1, RNS-2 e NIVA 3 deve ser instalado

- a mais de 3,50 m da beira da piscina. Esta distância é avaliada tendo em conta o contorno dos obstáculos. Se o quadro do RNS-1, RNS-2 e NIVA 3 for instalado atrás de uma parede, trata-se então da distância necessária para dar a volta e entrar no quadro.
- ou num local enterrado com proximidade imediata da piscina. Neste caso, o local deve ser acessível através de um alçapão, sendo necessário uma ferramenta para a sua abertura.
- após uma proteção diferencial de alta sensibilidade (30mA) de acordo com a norma NF C15-100

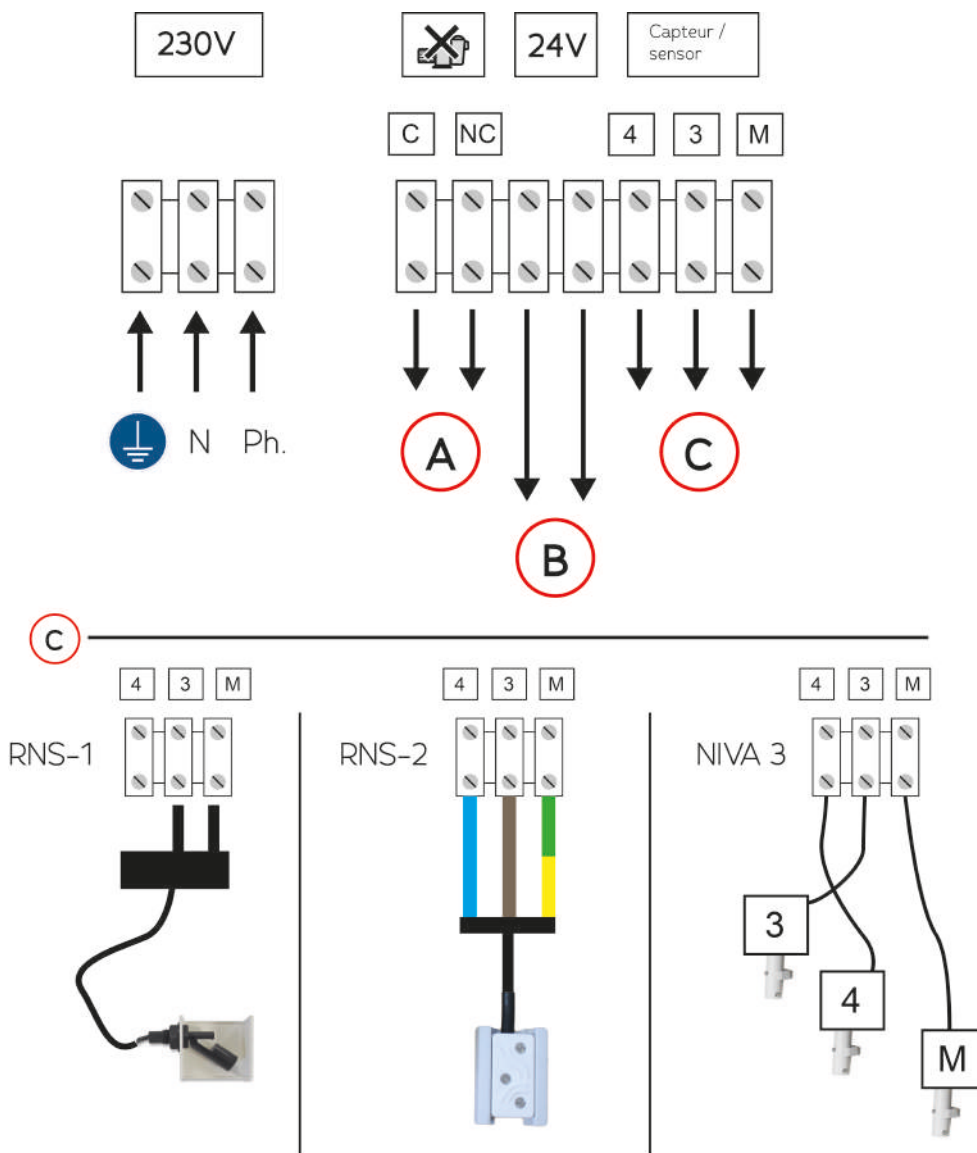

- A. Interdição bomba (ver mais abaixo para mais detalhes)
- B. Saída 24V para eletroválvula
- C. Ligação do sensor de nível fornecido com o quadro.

*Consoante o sensor de nível utilizado, a ligação é diferente. A parte inferior da imagem (C) descreve as possíveis ligações.*

### 3.1.1. Ligação interdição bomba

#### 3.1.1.1. Num quadro elétrico da marca CCEI

Os quadros elétricos fabricados por CCEI estão equipados de um bloco de terminais pré-conectado, marcado ABCD para as regulações de nível automático.

- **A e B:** marcha forçada da bomba de filtração (não usada para os RNS-1, RNS-2 e NIVA 3)
- **C e D:** interdição bomba

Basta então retirar o "shunt" existente entre C e D na caixa de filtração e ligar no seu lugar os 2 fios provenientes da saída "Interdição bomba" do quadro RNS-1, RNS-2 e NIVA 3.

#### 3.1.1.2. Num quadro elétrico standard

Se o quadro elétrico não estiver pré-equipado para uma regulação de nível automático, é necessário conectar-se diretamente ao interruptor de filtração. As seguintes informações são fornecidas apenas a título informativo e é imperativo seguir as instruções do seu quadro elétrico da piscina ou contactar previamente o fabricante do seu quadro.

##### Interdição bomba:

Ligue o bloco de terminais Interdição bomba ao terminal A1 do interruptor de filtração

- **A:** fios existentes na caixa de filtração
- **B:** interruptor de filtração instalado no quadro
- **C:** fio a acrescentar para ligar a Interdição bomba ao quadro RNS-1, RNS-2 e NIVA 3

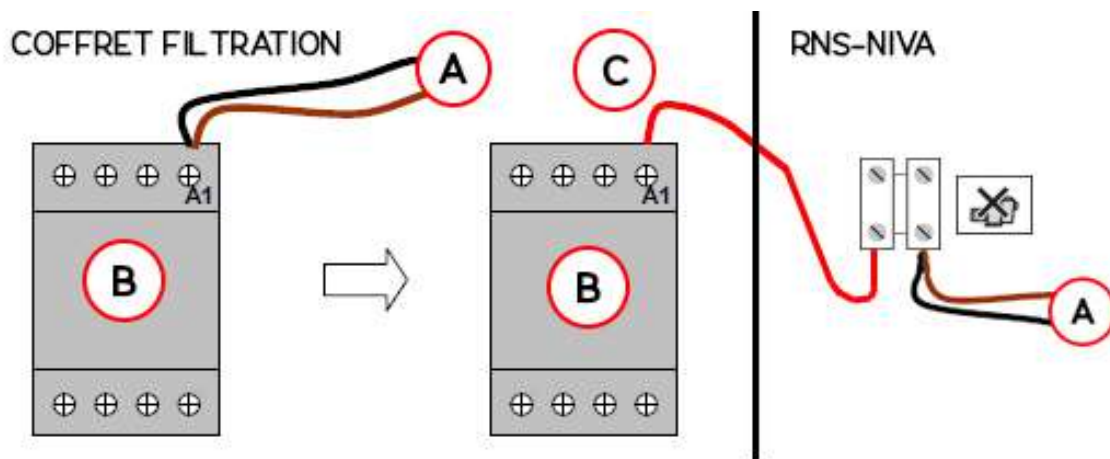

Desligar o(s) fio(s) à chegada do terminal A1 do interruptor de filtração e enviá-lo(s) para um terminal do domínio "Interdição bomba" da caixa RNS-1, RNS-2 e NIVA 3. Em seguida, ligar através de um fio o outro terminal do domínio "Interdição bomba" ao terminal A1 do interruptor de filtração.

## 4. Funcionamento do aparelho - descrição das funções

### 4.1. Funcionalidades disponíveis (consoante versão)

#### 4.1.1. Temporização

A fim de tornar o sistema insensível ao corte, o dispositivo eletrónico retarda a deteção de uma mudança de nível. Assim, o dispositivo só abre a eletroválvula de enchimento quando o nível detetado permanecer abaixo do nível de limiar durante 10 segundos.

Da mesma forma, a eletroválvula só fechará quando o nível tiver estabilizado acima do nível de limiar durante 5 segundos.

#### 4.1.2. Saída interdição bomba

O RNS-1, RNS-2 e NIVA 3 tem uma saída Interdição Bomba para evitar que a bomba funcione quando há falta de água.

#### 4.1.3. Saída eletroválvula de enchimento

Nesta saída, o RNS-1, RNS-2 e NIVA 3 envia 24V CA quando o enchimento é necessário. Ligue

esta saída à eletroválvula fornecida com o módulo. Quando o enchimento está ativo, o LED



acende-se.

##### 4.1.3.1. Falha no enchimento

Se o nível elevado não for atingido após 3 horas, a caixa entra em modo de monitorização durante 30

minutos e o indicador luminoso  está aceso em laranja (LEDs verdes + vermelhos). Após 30

minutos, se o nível ainda não for atingido, o enchimento é interrompido e a interdição bomba per-

manece ativada por razões de segurança. O indicador luminoso  fica então aceso a vermelho.

O sensor de nível e a eletroválvula de enchimento devem então ser controlados. Para desativar a falha, é necessário desligar e voltar a ligar o aparelho.

## 5. Instalação dos acessórios

### 5.1. Flutuador MFP-2 (RNS-1)

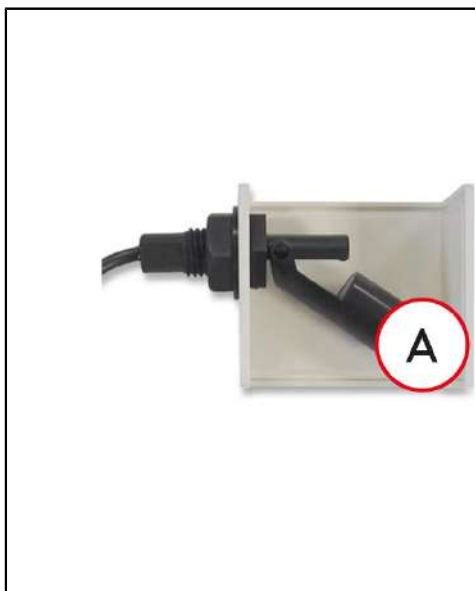

O flutuador MFP-2 fixa-se a um skimmer. Usar preferencialmente cola silicone ou neoprene e tome cuidado para não obstruir a saída do cesto do filtro.

#### A. Flutuador

O aparelho funciona como um "tudo ou nada". A altura do flutuador varia de acordo com o nível da água e quando o flutuador está abaixo da posição horizontal (por exemplo, como mostrado na figura) em que ativa o enchimento e a interdição bomba.

Uma vez atingido o nível da água, o aparelho para o enchimento e reinicia a bomba de filtração.

### 5.2. Sonda SE-3 (RNS-2)

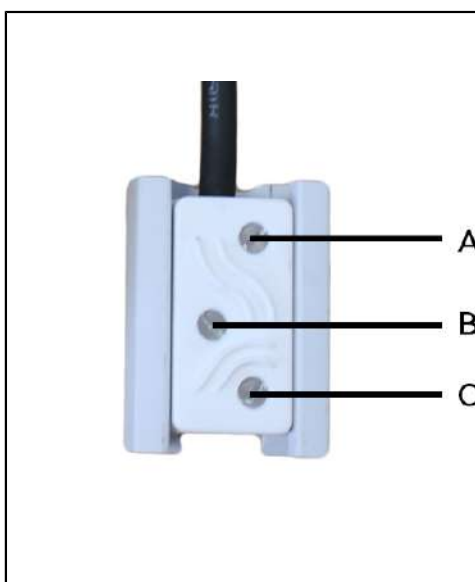

A sonda SE-3 é fixada no skimmer. Usar preferencialmente cola silicone ou neoprene.

#### A. Nível alto

#### B. Nível baixo

#### C. Nível ref.



Se o nível da água estiver acima do nível alto (A), a filtração é permitida e o enchimento automático é interrompido.

Se o nível da água estiver abaixo do nível baixo (B), o aparelho para a filtração (interdição bomba) e aciona o enchimento até alcançar o nível alto (A).

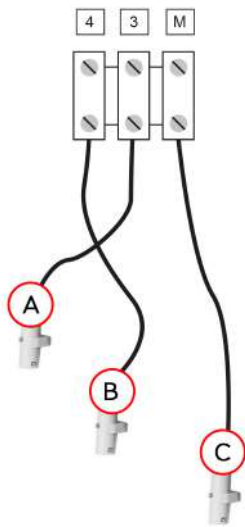
### 5.3. Sondas SE-1 (Niva-3)

	<p>As 3 sondas SE-3 são posicionadas no skimmer, separadas umas das outras. Recomendamos a sua instalação numa calha ou num tubo de PVC para as isolar da parede e mantê-las separadas. As sondas devem ser fixadas na altura desejada para evitar o seu movimento e para evitar qualquer tração no fio. Os fios das sondas devem ser guiados de forma a evitar o enredamento.</p> <p>A. Nível alto (a ser ligado ao terminal 3)          B. Nível baixo (a ser ligado ao terminal 4)          C. Nível ref. (a ligar ao terminal M)</p> <p>Se o nível da água estiver acima do nível alto (A), a filtração é permitida e o enchimento automático é interrompido.</p> <p>Se o nível da água estiver abaixo do nível baixo (B), o aparelho para a filtração (interdição bomba) e aciona o enchimento até alcançar o nível alto (A) ou para-o após 3 horas (ver parágrafo Falha).</p>
-----------------------------------------------------------------------------------	---------------------------------------------------------------------------------------------------------------------------------------------------------------------------------------------------------------------------------------------------------------------------------------------------------------------------------------------------------------------------------------------------------------------------------------------------------------------------------------------------------------------------------------------------------------------------------------------------------------------------------------------------------------------------------------------------------------------------------------------------------------------------------------------------------------------------------------------------------------------------------------------

### A. Declaração de conformidade

<p>A sociedade CCEI S.A.S (FR 47 40 35 21 693) declara que o produto RNS-1, RNS-2 e NIVA 3 cumpre as exigências de segurança e compatibilidade eletromagnética das diretivas europeias C.E.M. (2014/30/UE), Baixa-Tensão (2014/35/UE), RoHS (2011/65/UE), WEEE (2002/96/CE) e REACH (1907/2006) .</p>		
		<p>Emmanuel Baret              Marseille, a 02/01/2020</p>
<p align="center"><b>Carimbo do Distribuidor</b></p>		
<p><i>Data da venda: ..... N.º de lote: .....</i></p>		