

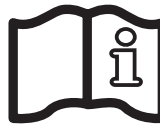

HAYWARD®

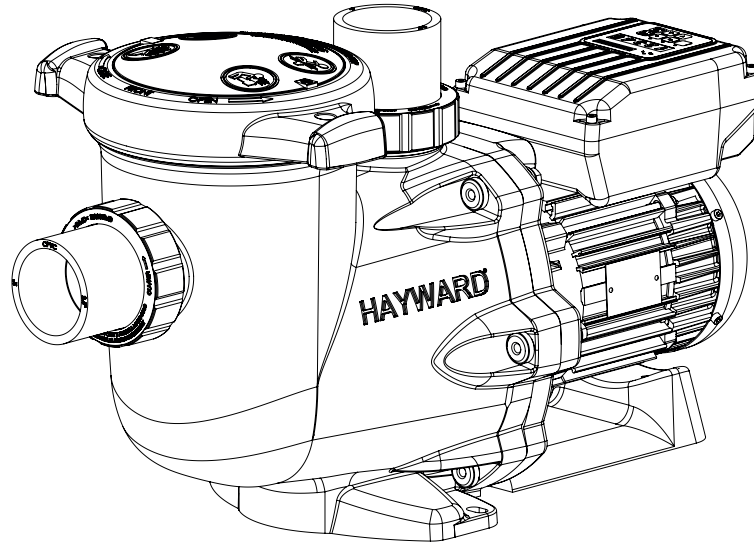

**GUIDE DE L'UTILISATEUR
USER'S GUIDE
MANUAL DEL USUARIO
MANUAL DO UTILIZADOR
ANWENDER - HANDBUCH
GEBRUIKERSHANDBOEK
MANUALE PER L'USO
ANVÄNDARHANDLEDNING
BRUGERVEJLEDNING
BRUKERVEILEDNING
KÄYTTÖOHJE
РУКОВОДСТВО ПО ЭКСПЛУАТАЦИИ**



HAYWARD®

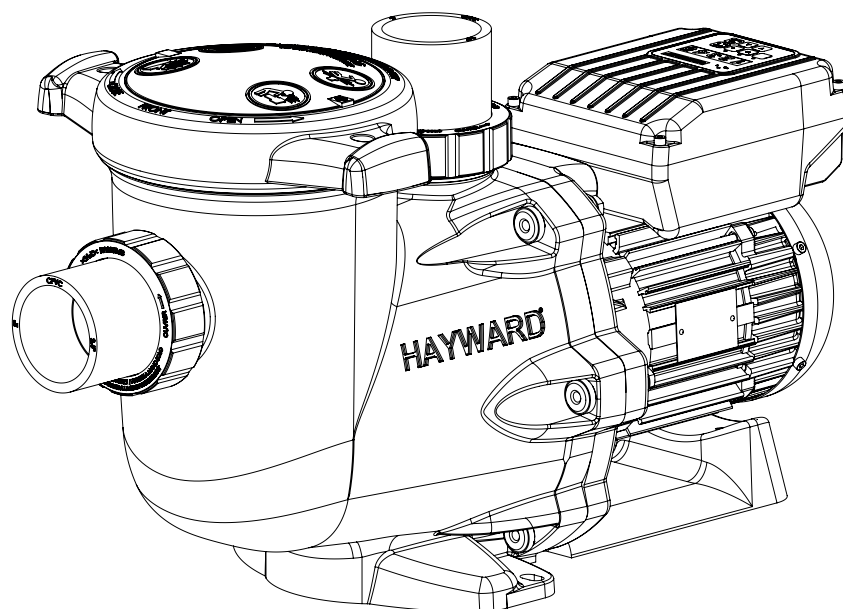

POMPE CENTRIFUGE À VITESSE VARIABLE

GUIDE DE L'UTILISATEUR

CONSERVEZ CE MANUEL POUR UNE CONSULTATION ULTÉRIEURE



ATTENTION: Danger Électrique. Le non respect des instructions suivantes risque de vous exposer à des blessures graves, voire un danger de mort.
APPAREIL DESTINÉ AUX PISCINES

⚠ ATTENTION – Débranchez totalement la pompe de l'alimentation secteur avant d'ouvrir le couvercle et de nettoyer le filtre.

⚠ ATTENTION – Toute installation électrique de pompe de piscine nécessite d'être réalisée dans les règles de l'art et conformément aux normes en vigueur ou, à défaut, à la norme internationale CEI 60364-7-70.

⚠ ATTENTION – Vérifiez que la machine est branchée sur une prise 230 V \surd protégée contre les courts-circuits. La pompe doit également être alimentée par l'intermédiaire d'un transformateur d'isolement ou d'un appareil de courant résiduel (RCD) dont le courant résiduel nominal de fonctionnement ne dépasse pas 30 mA.

⚠ ATTENTION – Veillez à ce que les enfants ne puissent pas jouer avec l'appareil. Veillez à placer vos doigts loin des ouvertures et des parties mobiles, et à empêcher tout objet étranger de pénétrer dans l'appareil.

⚠ ATTENTION – Le moteur doit être convenablement relié à la terre. Branchez le conducteur de mise à la terre sur la vis de mise à la terre, de couleur verte, et utilisez une prise de courant à contact de mise à la terre appropriée pour les appareils à connexion par câbles.

⚠ ATTENTION – Utilisez une patte de raccordement pour raccorder le moteur aux autres parties liées à la masse, en utilisant un conducteur de dimensions appropriées, conformément au code de l'électricité.

⚠ ATTENTION – Pendant l'établissement des connexions électriques, consultez le diagramme qui se trouve sous le couvercle du boîtier de connexions du moteur. Assurez-vous que les connexions électriques sont étanches et imperméables avant de mettre l'appareil en marche. Remettez tous les couvercles en place avant d'utiliser l'appareil.

⚠ ATTENTION – Vérifiez que la tension d'alimentation requise pour le moteur correspond bien à celle du réseau de distribution et que les câbles d'alimentation sont adaptés à la puissance et au courant de la pompe.

⚠ ATTENTION – Lire attentivement les instructions de ce manuel et celles figurant sur l'appareil. Le non respect des consignes pourrait être à l'origine de blessures.
Ce document doit être remis à tout utilisateur de piscine qui le conservera en lieu sûr.

⚠ ATTENTION – L'utilisation, le nettoyage ou la maintenance de l'appareil par des enfants d'au moins huit ans ou par des personnes aux aptitudes physiques, sensorielles ou mentales réduites ou un manque d'expérience ou de savoir-faire, devra se faire uniquement après avoir reçu des instructions appropriées et sous la supervision adéquate d'un adulte responsable afin d'assurer une manipulation en toute sécurité et d'éviter tout risque de danger. Cet appareil doit rester hors de portée des enfants.

⚠ ATTENTION – La pompe est prévue pour un fonctionnement continu à une température d'eau maximale de 35°C.

⚠ ATTENTION – N'utilisez que des pièces détachées d'origine Hayward®.

⚠ ATTENTION – Si le câble d'alimentation est endommagé, il doit être remplacé par le fabricant, son service après vente ou des personnes de qualification similaire, afin d'éviter un danger.

⚠ ATTENTION – Pour débrancher la pompe de l'alimentation secteur, un interrupteur extérieur avec une séparation de contact sur tous les pôles assurant une déconnexion totale en cas de surtension, catégorie III, doit être intégré dans le boîtier fixe, conformément aux règles applicables aux câblages.

⚠ ATTENTION – La pompe de la piscine ne doit jamais être mise en marche si le cordon d'alimentation ou le carter du boîtier de commande du moteur est endommagé, sous peine de provoquer un choc électrique. Un cordon d'alimentation ou un boîtier de commande du moteur endommagé doit immédiatement être remplacé par un technicien agréé ou une personne qualifiée afin d'écartier tout danger.

⚠ ATTENTION – Ce moteur n'est PAS équipé d'un SVRS (Système de Sécurité Antiplaquage). Le SVRS aide à empêcher les noyades, lorsque des personnes se trouvent plaquées sur les bouches d'évacuations, sous la surface de l'eau. Dans certaines configurations de piscine, si le corps d'une personne bouche l'évacuation, cette personne risque d'être prise au piège par l'aspiration. Selon la configuration de votre piscine, la réglementation locale peut exiger l'installation d'un SVRS.

⚠ ATTENTION – Cette pompe contient une batterie qui, pour des raisons de sécurité, toute manipulation doit être effectuée par un service technique agréé.

N'UTILISEZ QUE DES PIÈCES DÉTACHÉES D'ORIGINE HAYWARD®

Félicitation, vous venez d'acquérir une pompe à vitesse variable Hayward®.

Les pompes à vitesse variable Hayward® possèdent un moteur à aimant permanent à commutation électronique AC de dernière génération. Ce moteur est piloté par un microprocesseur allié à un variateur de fréquence permettant les caractéristiques suivantes :

- Affichage de la vitesse de rotation sur l'écran de contrôle
- 3 vitesses de rotation prédéfinies en usine (boutons V1, V2, V3), vitesses réglables par l'utilisateur
- Amorçage systématique à chaque démarrage, vitesse et durée d'amorçage réglables
- Fonction Skimmer, écrémage de la surface de l'eau
- Fonction Timer programmable
- Affichage de la puissance instantanée consommée
- Affichage de la consommation d'énergie totale et partielle
- Affichage du temps de fonctionnement de la pompe
- Faible niveau sonore
- Standard de construction TEFC IP55

Installer la pompe à bonne distance du bassin pour réduire le plus possible la liaison entre l'aspiration et la pompe, ceci afin de limiter les pertes de charges inutiles et excessives sur le circuit hydraulique.

Il faut toutefois impérativement respecter une distance de sécurité demandée par la norme d'installation en vigueur (3.5 m minimum pour respecter la norme NF C 15-100). Installer et utiliser le produit à une altitude inférieure à 2000 m.

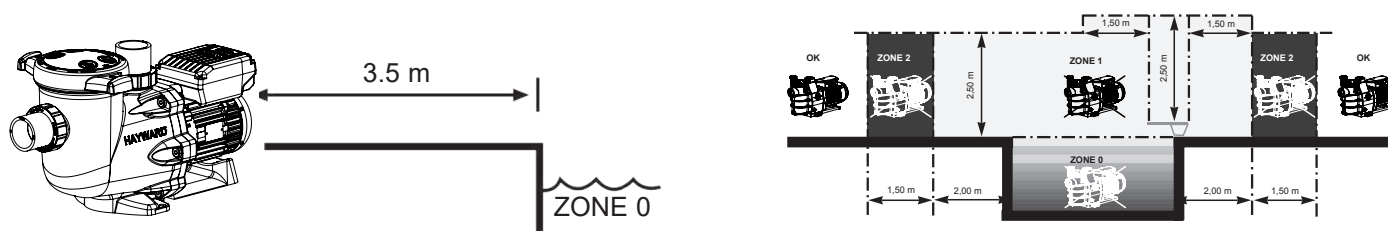

Installer la pompe dans un local ventilé et sec, le moteur exige que l'air circule librement autour de celle-ci pour permettre sa ventilation naturelle. Prévoir un dégagement minimum de 0,5 m autour de la pompe. Vérifier régulièrement que des objets, des feuilles ou tout autre encombrant ne viennent pas obstruer le refroidissement du moteur.

La pompe doit être installée de manière que l'interrupteur extérieur de déconnexion qui est intégré dans le boîtier fixe soit visible et facilement accessible. L'interrupteur doit être situé près de la pompe.

La pompe doit être installée en permanence sur un socle en béton grâce à des tire-fonds de Ø 8 mm adaptés au béton, vissés aux emplacements où des trous d'implantation ont été réalisés. Des rondelles d'arrêt doivent être prévues pour empêcher tout desserrement des tire-fonds de montage avec le temps. Si la pompe doit être montée sur un plancher en bois, des vis à bois à tête hexagonale de Ø 8 mm adaptées pour le bois doivent être utilisées – ainsi que des rondelles freins destinées à empêcher tout desserrement dans le temps.

Installer la pompe à l'abri afin de ne pas exposer le boîtier de contrôle à de fortes projections d'eau.

La pression acoustique des pompes Hayward® est inférieure à 70 dBA.

Dispositions nécessaires:

- Raccorder la pompe à la terre : ne jamais faire fonctionner la pompe sans que celle-ci soit raccordée à la terre.
- Raccorder la pompe avec un câble souple 3G1,5mm² de type H07RN-F.
- Prévoir un dispositif de protection différentiel 30 mA, destiné à protéger les personnes contre les chocs électriques provoqués par une éventuelle rupture de l'isolation électrique de l'équipement.
- Prévoir une protection contre les courts circuits (la définition du calibre est faite en fonction de la valeur relevée sur la plaque du moteur).
- Prévoir un moyen de déconnexion du réseau d'alimentation ayant une distance d'ouverture des contacts de tous les pôles assurant une coupure complète dans les conditions de catégorie de surtension III.

⚠ ATTENTION : attendre 5 minutes après avoir totalement déconnecté la pompe du réseau électrique avant d'intervenir sur le moteur ou le boîtier de raccordement : **risque de choc électrique pouvant entraîner la mort.**

Les moteurs électriques qui équipent nos pompes sont pourvues d'une protection thermique, cette protection réagit lors d'une surcharge ou échauffement anormal du bobinage moteur. Cette protection se réarme automatiquement lorsque la température du bobinage baisse.

Si la réglementation l'impose et quel que soit le type de moteur utilisé, il faut en plus des dispositifs énumérés ci-dessus, installer une protection magnéto-thermique qui doit être calibrée selon les indications de la plaque moteur.

Le tableau en page 168 donne les différentes caractéristiques du moteur qui équipent nos pompes.

N'UTILISEZ QUE DES PIÈCES DÉTACHÉES D'ORIGINE HAYWARD®

Raccordement électrique : S'assurer que la tension d'alimentation exigée par le moteur correspond à celle du réseau de distribution et que la section et longueur du câble d'alimentation sont adaptées à la puissance et à l'intensité de la pompe. L'ensemble des raccordements électriques de la pompe ainsi que l'éventuel changement du câble d'alimentation doivent être réalisés par un professionnel qualifié afin d'éviter tout danger.

Pour réaliser ces raccordements électriques, respecter le repérage inscrits en dessous des bornes de raccordement.

Bien vérifier le serrage et l'étanchéité des connexions électriques avant la mise sous tension.

Bien respecter le passage du câble par l'orifice et ferrite prévus à cet effet; le presse étoupe assurant l'étanchéité autour du câble, la ferrite constituant un filtre pour les perturbations électromagnétiques.

Le pré-câblage éventuel qui équipe certaines de nos pompes doit être retiré lors du raccordement définitif de la pompe à l'alimentation électrique. En effet ce pré équipement n'est utilisé que pour les tests en usine pendant les phases de fabrication.

INSTALLATION

Installer la pompe de la piscine en limitant au maximum les pertes de charges tout en respectant les conditions d'éloignement, 3,5 m minimum entre celle-ci et la piscine comme précisé dans la norme d'installation NF C 15-100. La conduite d'aspiration doit être installée avec une faible pente ascendante vers l'axe de la pompe. S'assurer que les raccords soient bien serrés et étanches. Toutefois, éviter de bloquer ces tuyauteries d'une façon exagérée. Pour les matières plastiques, assurer l'étanchéité avec du Téflon uniquement. Le tuyau d'aspiration aura un diamètre plus grand ou au moins égal a celui du refoulement. Éviter des emplacements non ventilés ou humides. Le moteur exige que l'air de refroidissement puisse circuler librement. Installer la pompe à l'abri afin de ne pas exposer le boîtier de contrôle à de fortes projections d'eau.

INSTRUCTIONS DE DÉMARRAGE ET D'AMORÇAGE : Remplir d'eau le corps du pré-filtre jusqu'au niveau du tuyau d'aspiration. Ne jamais faire fonctionner la pompe sans eau, cette eau étant nécessaire au refroidissement et à la lubrification de l'obturateur mécanique. Ouvrir toutes les vannes des conduites d'aspiration et de refoulement, de même que la purge d'air du filtre s'il en est pourvu. (Toute présence d'air dans les conduites d'aspiration devra être éliminée). Démarrer le groupe et attendre un temps raisonnable pour l'amorçage. Cinq minutes n'est pas un laps de temps exagéré pour amorcer (cet amorçage dépend de la hauteur d'aspiration et de la longueur du tuyau d'aspiration). Si la pompe ne démarre pas ou ne s'amorce pas voir le guide de recherche des pannes.

UTILISATION DU BOÎTIER DE COMMANDE

1. PRÉSENTATION

La pompe à vitesse variable Hayward® est pilotée par un boîtier de commande qui permet de visualiser les paramètres de fonctionnement, de les régler et de programmer le mode Timer.

1	Témoin LED de mise sous tension
2	Écran d'affichage LCD
3	Sélection de la vitesse
4	Bascule entre mode Manuel / modeTimer
5	Boutons de réglage haut / bas
6	Bouton Marche / Arrêt
7	Bouton d'affichage des paramètres
8	Témoins LED pour vitesse sélectionnée

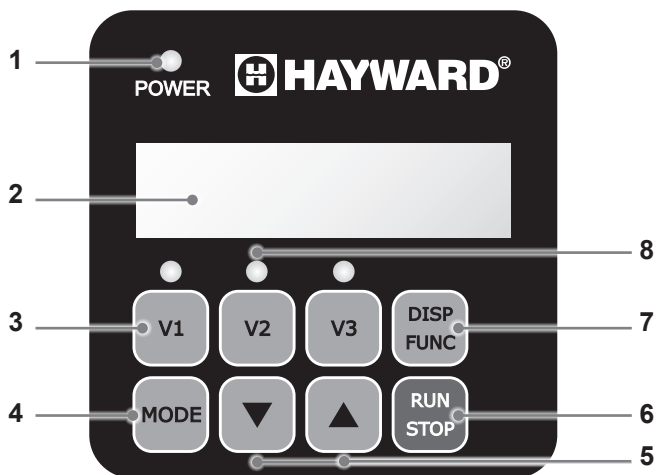

La pompe est livrée avec des **PARAMÈTRES PAR DÉFAUT** (réglages usine) :

Amorçage durée (s)	Amorçage vitesse (rpm)	V1 (rpm)	V2 (rpm)	V3 (rpm)	Skimmer durée (min)	Skimmer cycle (h)	Skimmer vitesse (rpm)
240	3000	1500	2400	3000	15	1h	2800

rpm : rotations par minute

N'UTILISEZ QUE DES PIÈCES DÉTACHÉES D'ORIGINE HAYWARD®

2. MODES DE FONCTIONNEMENT DE LA POMPE

2.1 Mode Manuel

En mode Manuel l'utilisateur démarre ou arrête la pompe manuellement, en fonction de l'utilisation de la piscine.

- Le démarrage de la pompe lance une phase d'amorçage (a). Cette phase est réglable (vitesse et durée, § 4.2) . L'amorçage peut être interrompu lors du démarrage (§ 3.2) ou désactivé par les réglages.
- La vitesse de la pompe se stabilise ensuite sur une valeur constante (b) (par défaut stabilisation à vitesse V2). Cette vitesse peut être sélectionnée et réglée par l'utilisateur (§ 3.3).
- Après un arrêt/redémarrage, la pompe se stabilisera sur la dernière vitesse mémorisée.

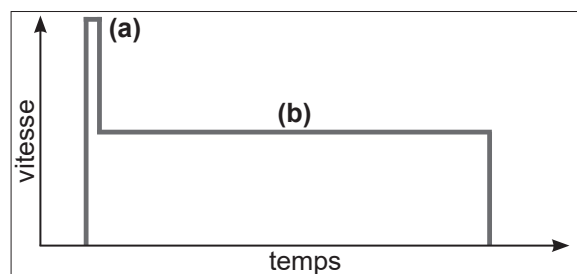

2.2 Skimmer

La fonction Skimmer permet d'écrémer la surface de l'eau, notamment pour éviter l'accumulation et la stagnation de saletés à la surface de la piscine.

- Cette fonction est automatique : la pompe fonctionne à une vitesse plus élevée (c) pendant une durée et selon un cycle réglables.
- En dehors de cette augmentation de la vitesse, la pompe retrouve sa vitesse normale, que ce soit en mode Manuel ou en mode Timer.
- La fonction Skimmer peut être désactivée (voir réglages § 4.3).

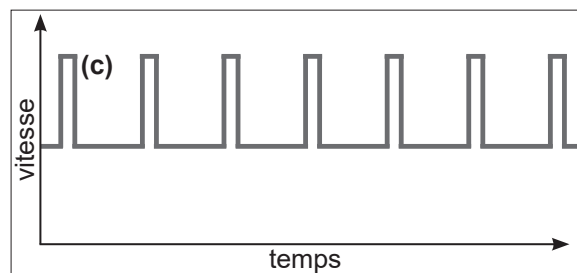

2.3 Mode Timer

En mode Timer le fonctionnement de la pompe est automatisé 24/24. Les différentes séquences de vitesse (d) sont à programmer par l'utilisateur. Elles seront choisies en fonction de l'installation (mode de chauffage, économiseur d'énergie, etc...) et des horaires d'utilisation de la piscine.

- Si la fonction Skimmer est activée, elle se superpose à ces séquences.
- La pompe peut être arrêtée (mise en pause) en mode Timer. Au redémarrage la vitesse sera celle du Timer en cours.
- Pour programmer le mode Timer reportez-vous au § 4.5.

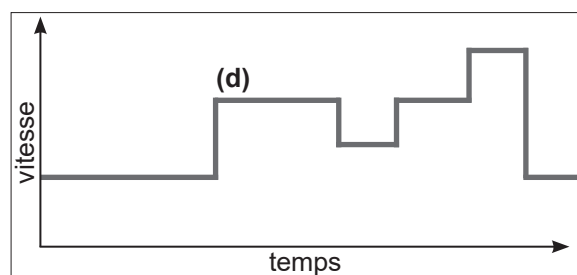

2.4 Bascule entre mode Manuel / mode Timer

Le changement de mode s'effectue en appuyant sur le bouton  comme illustré ci-dessous :

Mode manuel

Affichage vitesse sans préfixe

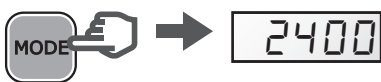

La LED allumée indique la vitesse sélectionnée (V2 par défaut)

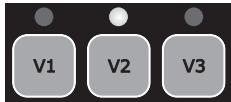

Mode Timer

Affichage vitesse avec préfixe "t"

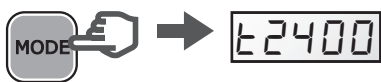

Les LEDs sont éteintes



N'UTILISEZ QUE DES PIÈCES DÉTACHÉES D'ORIGINE HAYWARD®

2.5 Raccordement des entrées digitales externes

⚠ ATTENTION : Avant toute intervention électrique sur la pompe, déconnectez-la du secteur et attendez 5 min.

La pompe de filtration est équipée d'un câble à 5 fils d'une longueur de 3 m permettant le raccordement de 4 entrées digitales ou contacts secs libres de potentiel (Ouvert/Fermé).

Exemples d'utilisation des entrées digitales

- Affecter la vitesse et le débit nécessaires au bon fonctionnement d'organes périphériques tels que une pompe à chaleur, un volet roulant ou un robot à aspiration, etc...
- Installer un rappel de commande de l'interface utilisateur. Ces entrées digitales permettent de piloter à une distance de 3 m la fonction Marche/Arrêt ainsi que les 3 vitesses (V1-V2-V3).

Affectation des fils		
DI1	Brun	Vitesse V1
DI2	Vert	Vitesse V2
DI3	Blanc	Vitesse V3
DI4	Rouge	Marche/Arrêt
C	Noir	Commun

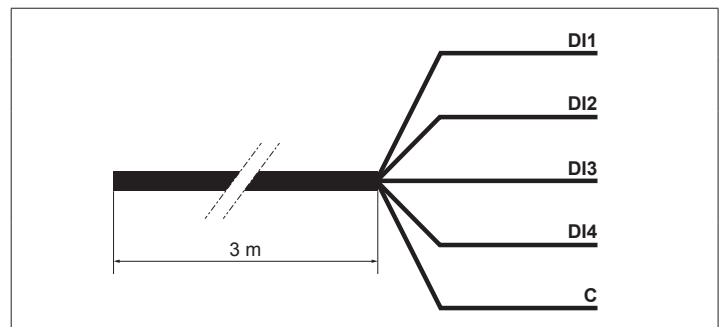

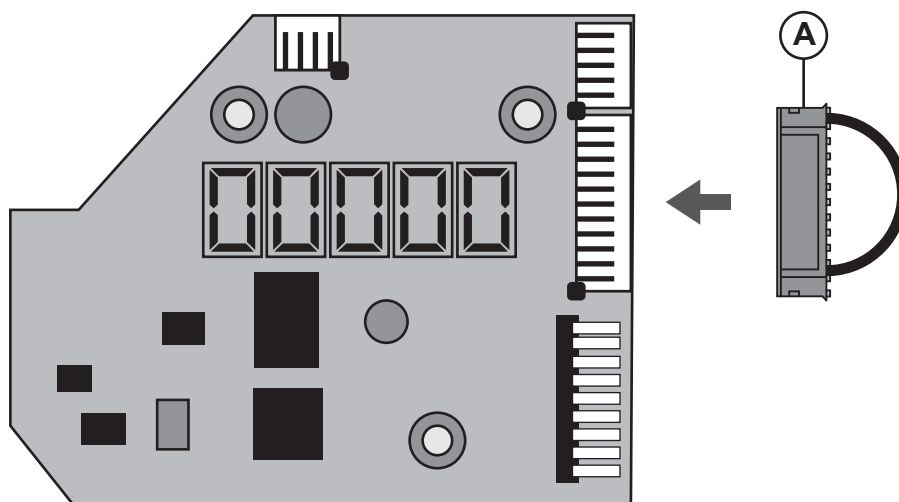

Nota :

- En cas d'utilisation partielle des entrées digitales, isoler électriquement les fils non utilisés.
- En cas de non-utilisation des entrées digitales, insérer le connecteur (A) en lieu et place du câble 5 fils (voir figure ci-dessous).



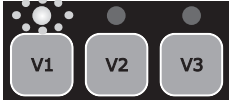

N'UTILISEZ QUE DES PIÈCES DÉTACHÉES D'ORIGINE HAYWARD®

Fonctionnement avec les entrées digitales

<p>Les entrées digitales sont utilisables en mode Manuel ou en mode Timer. Elles ont le niveau de priorité le plus élevé : elles sont MAITRE sur toutes les fonctions en cours d'utilisation. Seuls les boutons Marche/Arrêt et DISP/FUNC restent actifs.</p>	<p>→ </p> <p>→ </p>
<p>Lorsqu'une entrée digitale est utilisée, la LED associée à la vitesse concernée clignote rapidement (DI1 = V1, DI2 = V2 ou DI3 = V3).</p>	<p>→ </p>

<p>Pour obtenir une action par les entrées digitales, l'entrée DI4 doit être fermée.</p>	<p>→ DI4 Marche/Arrêt Fermé</p>																
<p>Si plusieurs entrées digitales sont commutées simultanément, une seule sera exécutée dans l'ordre de priorité défini par le tableau ci-contre.</p>	<table border="1"> <thead> <tr> <th></th> <th>DI1 = V1</th> <th>DI2 = V2</th> <th>DI3 = V3</th> </tr> </thead> <tbody> <tr> <th>DI1 = V1</th> <td>V1</td> <td>V2</td> <td>V3</td> </tr> <tr> <th>DI2 = V2</th> <td>V2</td> <td>V2</td> <td>V3</td> </tr> <tr> <th>DI3 = V3</th> <td>V3</td> <td>V2</td> <td>V3</td> </tr> </tbody> </table>		DI1 = V1	DI2 = V2	DI3 = V3	DI1 = V1	V1	V2	V3	DI2 = V2	V2	V2	V3	DI3 = V3	V3	V2	V3
	DI1 = V1	DI2 = V2	DI3 = V3														
DI1 = V1	V1	V2	V3														
DI2 = V2	V2	V2	V3														
DI3 = V3	V3	V2	V3														

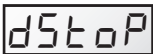
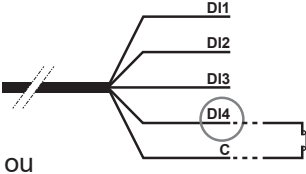
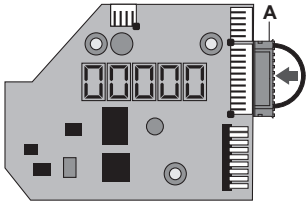
Nota : une fois que l'action associée à l'entrée digitale est terminée (contact ouvert), la pompe de filtration reprend l'action du mode de fonctionnement en cours.



<p>Si l'entrée digitale DI4 est ouverte, la pompe de filtration ne démarre pas et dSTOP s'affiche sur l'écran de la pompe.</p> <ul style="list-style-type: none"> • Fermer l'entrée DI4. • Appuyer éventuellement sur RUN/STOP pour démarrer la pompe de filtration. 	<p>→ </p> <p>→ </p> <p>OU</p> <p>→ </p> <p>→ </p>
--	---

N'UTILISEZ QUE DES PIÈCES DÉTACHÉES D'ORIGINE HAYWARD®

3. UTILISATION









3.1 Mise sous tension

Le témoin "Power" s'allume ; l'écran effectue un test LCD puis affiche la version du software

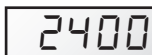





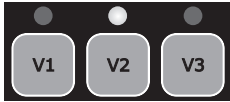

→

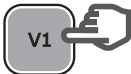
→

3.2 Phase d'amorçage

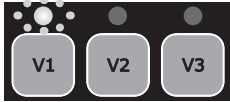
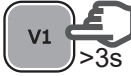
Après la mise sous tension de la pompe, la phase d'amorçage se lance automatiquement (idem après un redémarrage de la pompe).









Lancement automatique de la phase d'amorçage : • La vitesse augmente jusqu'à 3000 rpm et est maintenue pendant 240 s (valeurs par défaut)		→		
Fin de la phase d'amorçage : • Par défaut la vitesse se stabilise sur V2 ou sur la dernière vitesse mémorisée • La LED correspondante s'allume (mode Manuel)		→		
Pour afficher le temps d'amorçage restant : • Appuyer sur DISP/FUNC • Le temps restant s'affiche en s		→		
Pour sortir avant la fin de la phase amorçage : • Appuyer sur RUN/STOP • Par défaut la vitesse se stabilise sur V2, ou sur la dernière vitesse mémorisée		→		

3.3 En mode Manuel : sélection, réglage et mémorisation d'une vitesse

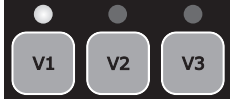
Pour sélectionner une vitesse : • Appuyer sur l'un des boutons vitesse • La valeur par défaut s'affiche (en rpm) • La LED correspondante s'allume		→		
Pour régler une nouvelle valeur de vitesse : • Appuyer sur les boutons de réglage haut / bas • La LED clignote : réglage en cours • Régler la valeur souhaitée (de 600 à 3000 rpm)		→		
Pour sauvegarder la nouvelle valeur de vitesse : • Appuyer pendant 3 s sur le bouton vitesse • La LED devient fixe lorsque la vitesse est mémorisée		→		

Nota : le débit d'eau généré par la vitesse de la pompe doit être adapté à la capacité de l'installation (filtre, canalisations...). Dans le doute, faites appel à un professionnel.

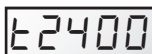
3.4 Arrêt / redémarrage de la pompe













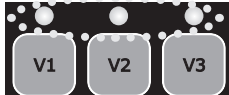

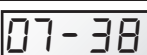
Pour arrêter la pompe : • Appuyer sur RUN/STOP • La pompe s'arrête, la LED vitesse reste allumée • En mode Manuel l'écran affiche "StoP" en fixe • En mode Timer l'écran affiche "StoP" en clignotant		→		
Pour redémarrer la pompe : • Appuyer sur RUN/STOP • La pompe démarre en phase d'amorçage (§ 3.2) • La vitesse se stabilise : en mode Manuel sur la dernière valeur mémorisée, en mode Timer sur la vitesse selon Timer en cours		→		
		→		

N'UTILISEZ QUE DES PIÈCES DÉTACHÉES D'ORIGINE HAYWARD®













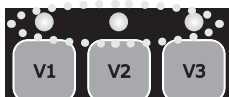

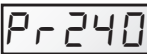





4. RÉGLAGES

Nota : pour accéder aux réglages la pompe doit être sous tension et **en mode Manuel** (§ 2.4), à l'arrêt ou en marche hors phase d'amorçage.
Si aucun bouton n'est appuyé pendant 2 min, l'affichage revient en normal (vitesse ou StoP) et les réglages ne sont pas sauvegardés.

4.1 Réglage de l'horloge

<ul style="list-style-type: none"> Appuyer pendant 3 s sur DISP/FUNC Les 3 LEDs clignotent L'écran affiche "ConF" puis "hr" 						
<ul style="list-style-type: none"> Appuyer sur DISP/FUNC, l'écran affiche l'heure de l'horloge interne (hh-min) 						
<ul style="list-style-type: none"> Appuyer sur les boutons de réglage bas / haut pour régler les heures / les minutes 						
<ul style="list-style-type: none"> Appuyer sur RUN/STOP pour sortir et sauvegarder L'affichage indique la vitesse en cours ou StoP 						
<p>Nota : le réglage de l'horloge interne est important si la pompe fonctionne en mode Timer. Il reste mémorisé lorsque la pompe est mise hors tension.</p>						

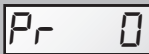
4.2 Réglage de l'amorçage

<ul style="list-style-type: none"> Appuyer pendant 3 s sur DISP/FUNC Les 3 LEDs clignotent et l'écran affiche "ConF" 					
<ul style="list-style-type: none"> Appuyer sur DISP/FUNC n fois jusqu'à obtenir à l'écran "Pr 240" durée de l'amorçage par défaut (s) 					
<ul style="list-style-type: none"> Appuyer sur les boutons de réglage haut / bas pour afficher la durée souhaitée (de 0 s à 300 s) 					
<ul style="list-style-type: none"> Appuyer sur DISP/FUNC : l'écran affiche "03000" vitesse d'amorçage par défaut (rpm) 					
<ul style="list-style-type: none"> Appuyer sur les boutons de réglage haut / bas pour afficher la valeur souhaitée (maxi 3000 rpm) 					
<ul style="list-style-type: none"> Appuyer sur RUN/STOP pour sortir et sauvegarder L'affichage indique la vitesse en cours ou StoP 					
<p>Nota : si la durée d'amorçage est à zéro l'affichage devient "ProFF" : l'amorçage est désactivé</p>					
					

4.3 Réglage de la fonction Skimmer

Voir le § 2.2 pour la présentation de cette fonction

<ul style="list-style-type: none"> Appuyer pendant 3 s sur DISP/FUNC Les 3 LEDs clignotent et l'écran affiche "ConF" 		→	ConF	
<ul style="list-style-type: none"> Appuyer sur DISP/FUNC n fois jusqu'à obtenir à l'écran "SFO.15" : durée d'activation du Skimmer par défaut (en minutes) 		→	SFO.15	
<ul style="list-style-type: none"> Appuyer sur les boutons de réglage haut / bas pour afficher la durée souhaitée (de 0 à 30 min) 		→	SFO20	
<ul style="list-style-type: none"> Appuyer sur DISP/FUNC : l'écran affiche "St 1h" : durée du cycle Skimmer par défaut 		→	St 1h	
<ul style="list-style-type: none"> Appuyer sur les boutons de réglage pour régler le cycle Skimmer sur 1 h, 2 h ou 3 h 		→	St 2h	
<ul style="list-style-type: none"> Appuyer sur DISP/FUNC : l'écran affiche "S2800" : vitesse du Skimmer par défaut (rpm) 		→	S2800	
<ul style="list-style-type: none"> Appuyer sur les boutons de réglage haut / bas pour afficher la vitesse souhaitée (de 600 à 3000 rpm) 		→	S2680	
<ul style="list-style-type: none"> Appuyer sur RUN/STOP pour sortir et sauvegarder L'affichage indique la vitesse en cours ou StoP 		→	1640 / StoP	
Nota : pour désactiver le Skimmer, mettre sa durée à zéro - L'affichage devient "SFoFF"		→	SFoFF	

4.4 Réinitialisation des paramètres

Pour restaurer les paramètres par défaut et effacer les réglages du mode Timer, procédez de la façon suivante :

<ul style="list-style-type: none"> Appuyer pendant 3 s sur DISP/FUNC Les 3 LEDs clignotent et l'écran affiche "ConF" 		→	ConF	
<ul style="list-style-type: none"> Appuyer sur DISP/FUNC n fois jusqu'à obtenir le message "Init" à l'écran 		→	Init	
<ul style="list-style-type: none"> Appuyer sur le bouton de réglage "haut" pendant 3 s. L'affichage passe à "donE" quand la réinitialisation est effectuée 		→	donE → StoP	

Rappel : paramètres par défaut et plages de réglage

	Amorçage		Boutons vitesse			Fonction Skimmer			Fonction Timer			
	Pr	o...	V1	V2	V3	SF	St	S...	t0	t1	t5	
Unité	s	rpm	rpm	rpm	rpm	min	h	rpm	hh-min	rpm	hh-min	rpm
Par défaut	240	3000	1500	2400	3000	15	1	2800	06-00	2400	oFF	0
Mini	0 (oFF)	600	600	600	600	0 (oFF)	1 ...	600	00-00	—	00-00	0/ 600
Maxi	300	3000	3000	3000	3000	30	... 3	3000	24-00	—	24-00	3000

N'UTILISEZ QUE DES PIÈCES DÉTACHÉES D'ORIGINE HAYWARD®

4.5 Programmation du mode Timer

Le boîtier de commande permet de programmer plusieurs séquences (voir § 2.3) ou Timers t0 à t5, qui ne doivent pas nécessairement suivre l'ordre chronologique.

Les Timer non utilisés seront désactivés.

Le Timer "t0" peut être fixé à 00:00, 06:00 (par défaut) ; 12:00 ou 18:00. Il ne peut pas être désactivé.

La vitesse du segment t0 n'est pas réglable, elle est fixée à 2400 rpm

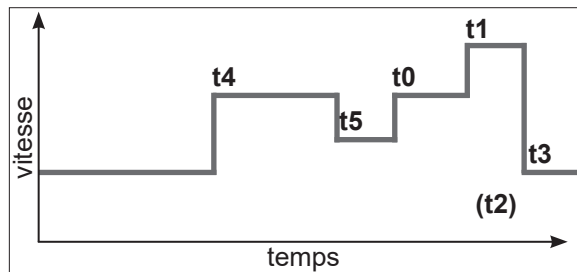

















- Tracez le profil de vitesse que vous souhaitez programmer. Le graphique ci-contre est donné à titre d'exemple.
- Vérifiez que l'horloge interne est correctement réglée.

• Appuyer pendant 3 s sur DISP/FUNC Les 3 LEDs clignotent et l'écran affiche "ConF"		→	ConF			
• Appuyer sur DISP/FUNC 2 fois jusqu'à obtenir l'affichage "t0"		→	t0			
• Appuyer sur DISP/FUNC, l'écran affiche "06-00" : valeur de t0 par défaut		→	06-00			
• Appuyer sur les boutons de réglage pour fixer le t0 souhaité (00-00, 06-00, 12-00 ou 18-00)		→	18-00			
• Appuyer sur DISP/FUN : l'écran affiche "t1oFF"		→	t1oFF			
• Pour activer ce Timer (exemple) appuyer sur le bouton "haut". L'écran affiche "t1 on"		→	t1 on			
• Appuyer sur DISP/FUNC : l'écran affiche "00-00"		→	00-00			
• Appuyer sur les boutons de réglage bas / haut pour régler l'horaire souhaité (hh-mm)		→	20-00		→	20-15
• Appuyer sur DISP/FUNC : l'écran affiche "0"		→	0			
• Appuyer sur les boutons de réglage pour afficher la vitesse souhaitée (de 600 à 3000 rpm ou zéro)		→	2740			
• Pour passer au Timer suivant appuyer sur DISP/FUN : l'écran affiche "t2oFF". Dans l'exemple ce Timer reste désactivé		→	t2oFF			
• Appuyer sur DISP/FUNC pour passer au Timer suivant et répétez les étapes de réglage (activation, horaire Timer et vitesse)		→	t3oFF	etc ...		
• Appuyer sur RUN/STOP pour sortir et sauvegarder L'affichage indique la vitesse en cours ou StoP		→	1640 / StoP			

N'UTILISEZ QUE DES PIÈCES DÉTACHÉES D'ORIGINE HAYWARD®

5. VISUALISATION DES PARAMÈTRES

Nota : la pompe doit être sous tension, en marche hors phase d'amorçage, ou à l'arrêt.
 Pour faire défiler les paramètres, appuyer sur la touche DISP/FUNC.
 Si aucune touche n'est appuyée pendant 15 s, l'écran repasse en affichage normal (vitesse en cours ou Stop).

<ul style="list-style-type: none"> Appuyer sur DISP/FUNC : l'écran affiche "hr" Appuyer à nouveau : affichage de l'heure interne 	 → hr	 → 11-45
<ul style="list-style-type: none"> Appuyer sur DISP/FUNC : l'écran affiche "t0" Appuyer à nouveau : affichage de l'horaire du t0 (la vitesse du t0 est fixée à 2400 rpm) 	 → t0	 → 12-00
<ul style="list-style-type: none"> Appuyer sur DISP/FUNC : l'écran affiche "t1" Appuyer à nouveau : affichage de l'horaire de ce Timer (hh-mm) 	 → t1	 → 09-20
<ul style="list-style-type: none"> Appuyer sur DISP/FUNC : affichage de la vitesse de ce Timer (en rpm) 	 → 1240	
<ul style="list-style-type: none"> Appuyer sur DISP/FUNC etc. : affichage des Timers suivants, horaire et vitesse, jusqu'au Timer "t5" <p>Nota : les Timers désactivés ne sont pas affichés</p>	 → t2	etc ...
<ul style="list-style-type: none"> Appuyer sur DISP/FUNC : affichage "P - - - -" Puissance consommée (en W, valeur à +/- 10%) <p>Nota : P = 0 W quand la pompe est à l'arrêt</p>	 → P 634 / P 0	
<ul style="list-style-type: none"> Appuyer sur DISP/FUNC : affichage "h - - - -" Compteur horaire de la pompe <p>Nota : Un tour compteur représente 9999 h</p>	 → h2857	
<ul style="list-style-type: none"> Appuyer sur DISP/FUNC : affichage "- - - - -" Consommation totale d'énergie (en kWh) <p>Nota : un tour compteur représente 99999 kWh</p>	 → 06542	
<ul style="list-style-type: none"> Appuyer sur DISP/FUNC : affichage "- - - - -" Consommation partielle d'énergie (en kWh), depuis la dernière remise à zéro 	 → 00086	
<ul style="list-style-type: none"> Pour remettre à zéro le compteur partiel d'énergie : Appuyer 3s sur l'un des boutons haut / bas. Le message "CLEAR" indique que le compteur est remis à zéro 	  → CLEAR	
<ul style="list-style-type: none"> Appuyer sur DISP/FUNC : affichage "SF On" ou "SFOFF" pour Skimmer activé / désactivé 	 → SF On / SFOFF	
<ul style="list-style-type: none"> Appuyer sur DISP/FUNC : affichage "t - -" Température du module de puissance (en °C) 	 → t 74	
<ul style="list-style-type: none"> Appuyer sur DISP/FUNC pour retourner à l'affichage normal (vitesse en cours ou Stop) 	 → 1640 / 5toP t2400 / 5toP	

N'UTILISEZ QUE DES PIÈCES DÉTACHÉES D'ORIGINE HAYWARD®

ENTRETIEN

1. Débranchez totalement la pompe de l'alimentation secteur avant d'ouvrir le couvercle et de nettoyer le pré-filtre. Nettoyer le panier du pré-filtre régulièrement, ne pas frapper sur le panier pour le nettoyer. Vérifier le joint du couvercle du pré-filtre et le remplacer si nécessaire.
2. L'axe de moteur est monté sur roulements auto-lubrifiants qui ne nécessitent aucune lubrification ultérieure.
3. Garder le moteur propre et sec et s'assurer que les orifices de ventilation soient libres de toute obstruction.
4. Occasionnellement la garniture mécanique peut accuser une fuite et devra alors être remplacé.
5. A l'exception du nettoyage de la piscine, toutes les opérations de réparation, d'entretien ou de maintenance doivent être impérativement effectuées par un agent agréé par Hayward® ou une personne qualifiée.

Les pièces d'usure de la pompe mentionnées ci-dessous doivent être entretenues en fonction de leur durée de vie estimée :

Durée de vie estimée des pièces d'usure:

Garniture mécanique et siège	1 année
Kit roulements moteur	1 année
Pack de joints (prefiltre, corps, raccords union, vidange)	2 années
Condensateur	2 années

HIVERNAGE

1. Vider la pompe en enlevant tous les bouchons de vidange et les conserver dans le panier du pré-filtre.
2. Déconnecter la pompe, enlever les raccords de tuyauteries et conserver le groupe complet dans un endroit sec et aéré ou au moins prendre la précaution suivante: déconnecter la pompe, enlever les 4 boulons de fixation du corps de pompe au support du moteur et conserver l'ensemble dans un endroit sec et aéré. Protéger ensuite le corps de pompe et de pré-filtre en les couvrant.

NOTE : avant de remettre la pompe en service, nettoyer toutes les parties internes en enlevant la poussière, le tartre, etc.

PANNES POSSIBLES ET SOLUTIONS

A) Le moteur ne démarre pas

1. Vérifier les raccordements électriques, les interrupteurs ou relais, de même que les coupe-circuit ou fusibles.
2. S'assurer manuellement de la libre rotation du moteur.
3. Vérifier que les vitesses de rotation V1, V2 et V3 ne soient pas programmées à 0 tr/min, le cas échéant procéder à une réinitialisation des paramètres usine (voir § 4.4).
4. Si l'écran affiche l'un des codes d'erreur ci-dessous, contacter votre installateur :

Err01	Sous-tension de la ligne continue	Err10	Problème d'alimentation électrique interne
Err02	Sur-tension de la ligne continue	Err20	Échecs de démarrage
Err04	Surchauffe du module de puissance	Err64	Problème de court circuit interne
Err05	Surchauffe moteur	Err97	Problème multiple
Err07	Sur-intensité	Err98	Problème de communication
		dStop	Voir en page 8

B) Le moteur s'arrête, vérifier

1. Les câbles, connections, relais, etc.
2. La chute de tension au moteur (fréquemment causée par des câbles trop faibles).
3. Qu'il n'apparaît aucun grippage ou surcharge (par lecture de l'ampérage absorbé).

NOTE : le moteur de votre pompe est équipé d'une protection thermique qui, en cas de surcharge, coupera automatiquement le circuit et évitera que le moteur ne se détériore. Ce déclenchement est causé par des conditions anormales d'utilisation qu'il est nécessaire de vérifier et de corriger. Le moteur redémarrera sans aucune intervention dès que les conditions normales de fonctionnement seront rétablies.

C) «OLOAD» apparaît sur l'afficheur (problème de surcharge ou surchauffe)

1. Vérifier que l'arbre moteur tourne librement
2. Vérifier qu'aucun débris n'encombre la libre rotation de la turbine
3. Vérifier que le moteur est correctement ventilé
4. Après avoir remédié au problème appuyez sur le bouton Marche/Arrêt

D) La pompe ne s'amorce pas

1. S'assurer que le corps du pré-filtre est bien rempli d'eau, que le joint du couvercle est propre et bien positionné et qu'aucune entrée d'air n'est possible. Au besoin, resserrer les vis de blocage de couvercle.
2. S'assurer que toutes les vannes d'aspiration et de refoulement sont ouvertes et non obstruées, et que toutes les bouches d'aspiration de la piscine sont entièrement immergées.
3. Vérifier si la pompe aspire en dégageant l'aspiration le plus près possible de la pompe:
 - a) si la pompe n'aspire pas malgré un remplissage suffisant en eau d'amorçage
 1. Resserrer les boulons et accessoires de tuyauterie du côté aspiration
 2. Vérifier la tension pour s'assurer que la pompe tourne à la bonne vitesse
 3. Ouvrir la pompe et vérifier que rien n'obstrue à l'intérieur
 4. Régler une vitesse d'amorçage suffisante
 5. Faites un nettoyage du filtre et réessayer
 6. Remplacer l'obturateur mécanique.
 - b) Essayer un amorçage en mode re-circulation. Si la pompe aspire normalement, vérifier la conduite d'aspiration et le pré-filtre qui pourraient être bouchés ou occasionner des prises d'air.

E) Pompe bruyante, vérifier

1. Si aucune entrée ou présence d'air à l'aspiration ne provoque de crépitements sourds dans la pompe.
2. S'il n'apparaît aucune cavitation causée par un diamètre insuffisant ou une restriction de la conduite d'aspiration. De même une conduite sur-dimensionnée au refoulement peut causer cette cavitation. Utiliser des tuyauteries correctes ou purger les conduites, si nécessaire.
3. S'il n'apparaît aucune vibration causée par un montage incorrect.
4. Si aucun corps étranger ne se trouve dans le corps de la pompe.
5. Si les roulements du moteur ne sont pas grippés par un jeu trop important, par la rouille ou par une surchauffe prolongée



HAYWARD®

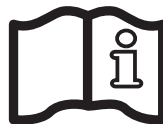
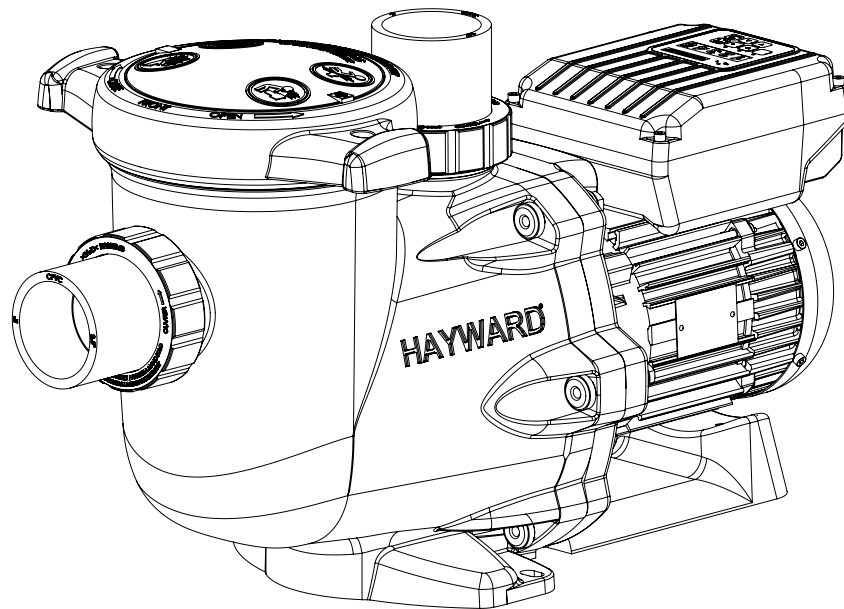

VARIABLE SPEED CENTRIFUGAL PUMP

USER GUIDE

KEEP THIS MANUAL FOR FUTURE REFERENCE



**WARNING: Electrical Hazard. Failure to follow instructions can result in serious injury or death.
FOR USE WITH SWIMMING POOLS**

⚠ WARNING – Disconnect the pump from the main power supply completely before servicing the pump or filter.

⚠ WARNING – All electrical connections must be done by a qualified electrician according to local electrical standard or, failing that, to the International Standard IEC 60364-7-702.

⚠ WARNING – Be certain the machine is only plugged into a protected 230 V[~] outlet that is protected from short-circuits. The pump is to be supplied by an isolating transformer or supplied through a residual current device (RCD) having a rated residual operating current not exceeding 30 mA.

⚠ WARNING – Children should be supervised to ensure that they do not play with the appliance. Keep fingers and foreign objects away from openings and moving parts.

⚠ WARNING – Motor must be suitably grounded. Connect ground wire to green grounding screw and for cord connected units use properly grounded outlet.

⚠ WARNING – Use a motor bonding lug to connect motor with other bonded parts using the appropriate size conductor as required by electrical codes.

⚠ WARNING – When making these electrical connections, refer to the diagram given under the lid of the motor terminal box. Be sure to check the electric connections are tight and sealed before powering up. Replace all covers before operation.

⚠ WARNING – Make sure that the power supply voltage required by the motor corresponds to that of the distribution network and that the power supply cables matches the power and current of the pump.

⚠ WARNING – Read and follow all instructions in this owner's manual and on the equipment. Failure to follow instructions can cause serious injury or death.

This document should be given to the owner of the swimming pool and must be kept by the owner in a safe place.

⚠ WARNING – The appliance can be used by children aged from 8 years and above and persons with reduced physical, sensory or mental capabilities, or lack of experience and knowledge, if they have been given supervision or instruction concerning use of the appliance in a safe way and understand the hazards involved.

⚠ WARNING – Cleaning and user maintenance shall not be made by children without supervision.

⚠ WARNING – The pump is intended for continuous operation at Maximum Water temperature 35°C.

⚠ WARNING – Use Only Genuine Hayward® Replacement Parts.

⚠ WARNING – If the supply cord is damaged it must be replaced by the manufacturer, service agent, or similarly qualified persons in order to avoid a hazard.

⚠ WARNING – For disconnection from main power supply an external switch having a contact separation in all poles that provide a full disconnection under overvoltage category III conditions must be incorporated in the fixed wiring in accordance with the wiring rules.

⚠ WARNING – Do not operate the swimming pool pump if the power cord or the housing of the motor connection box is damaged. This can cause an electric shock. A damaged power cord or motor connection box must be replaced by a service agent or a similarly qualified person immediately in order to avoid a hazard.

⚠ WARNING – This pool motor is NOT equipped with a Safety Vacuum Release System (SVRS). SVRS helps prevent drowning due to body entrapment on underwater drains. In some pool configuration, if a person's body covers the drain, the person can be trapped by suction. Depending on your pool configuration, a SVRS may be required to meet local requirements

⚠ WARNING – This pump contains a battery that, for safety reasons, any manipulation must be carried out by an authorized technical service..

USE ONLY HAYWARD® GENUINE REPLACEMENT PARTS

GENERAL POINTS

Congratulations, you have just acquired a Hayward® variable speed pump. Hayward® variable speed pumps® have a state-of-the-art permanent-magnet motor with AC electronic switching. This motor is controlled by a microprocessor combined with a frequency variator providing the following characteristics:

- Rotation speed is displayed on the control display
- 3 factory preset rotation speeds (buttons V1, V2, V3), as well as custom speeds set by the user
- Regular priming each time you switch on, with adjustable speed and duration
- Skimmer function, which skims the water's surface
- Programmable Timer function
- Current power usage displayed
- Partial and total power consumption displayed
- Running time of the pump displayed
- Low noise level
- Construction standard TEFC IP55

Install the pump at a suitable distance from the pool to reduce the distance between the suction point and the pump as much as possible to avoid pointless excessive pressure drops on the hydraulic circuit. However, it is essential to comply with the safety distance required by the current installation standard (3.5 m minimum). Install and use the product at an altitude less than 2000 m

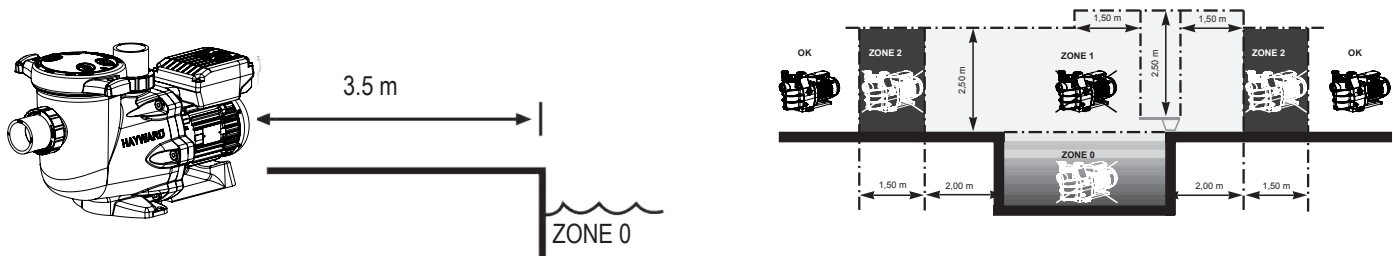

Install the pump in a dry, well-ventilated place. The motor requires the air to circulate freely around it to allow natural ventilation. Clear a space of at least 0.5m around the pump. Check regularly that no objects, leaves or other debris are blocking the motor cooling system.

The pump must be installed to ensure that the external disconnection switch incorporated into the fixed unit is visible and easily accessible. The switch must be located near to the pump.

The pump must be permanently installed on a concrete base using 8mm lag screws suitable for concrete, screwed into drilled implantation holes. Lock washers must be used to prevent the installation lag screws working loose over time. If the pump has to be mounted on a wooden board, Ø 8 mm hexagonal wood screws must be used combined with lock washers to prevent the screws working loose over time.

Install the pump under shelter to avoid the control unit being subject to heavy splashing.

The acoustic pressure of Hayward® pumps is less than 70 dBA.

Necessary measures:

- Connect the pump to the earth: Never operate the pump unless it is connected to the earth.
- Connect the pump with a H07RN-F 3G1,5mm² type cable.
- Include a 30 mA differential protection to protect people against electric shocks which may be caused by a breach of the equipment's electrical insulation.
- Include short-circuit protection (the rating is determined according to the value given on the nameplate on the motor).
- Include a means of disconnection from the power supply having an opening distance on the contacts of all the poles ensuring the power supply is completely cut off under the conditions of a category III overvoltage.

⚠ WARNING: Wait 5 minutes after having totally disconnected the pump from the power supply before carrying out any operation on the motor or the connection box: Danger of electric shock which may cause death.

The electric motors fitted to our pumps have thermal protection. This protection reacts in the event of overload or abnormal temperature rise in the motor winding. This protection automatically resets when the winding temperature drops. Whatever the type of motor used, if the regulations require it, a magnetic thermal protection must be installed in addition to the measures described above, which must be calibrated according to the information on the motor's nameplate. The table on page 169 gives the various characteristics of the motors fitted to our pumps.

USE ONLY HAYWARD® GENUINE REPLACEMENT PARTS

Electrical connection: Ensure that the supply voltage required by the motor corresponds to that of the distribution network and that the section and length of the power cable are adapted to the power and current of the pump. All the electrical connections on the pump and any change of power cable must be done by a qualified professional to avoid any danger.

When carrying out the electrical connections, comply with the identification under the connection terminals.

Check that the electrical connections are correctly tightened and watertight before switching on the power.

Ensure the cable runs correctly through the opening and ferrite provided for this purpose. The cable gland ensures watertightness around the cable, and the ferrite acts as a filter against electromagnetic disturbance.

Any pre-wiring on our pumps must be removed when the pump is permanently connected to the power supply. This preparation is only used for testing at the factory during the manufacturing phases.

INSTALLATION

Install the pool pump so as to reduce pressure drops to a minimum whilst complying with the distances specified in the installation standard, namely 3.5m minimum between the pump and the pool. The suction pipe must be installed with a slight uphill incline towards the pump axis. Ensure that the connections are correctly tightened and watertight. However, avoid excessively tightening the pipes. For plastic materials, use Teflon only to ensure watertightness. The diameter of the suction pipe shall depend on that of the discharge pipe. Avoid damp or non-ventilated locations. The motor requires the cooling air to circulate freely. Install the pump under shelter to avoid the control unit being subject to heavy splashing.

INSTRUCTIONS FOR START-UP AND PRIMING: Fill the body of the strainer with water up to the level of the suction pipe. Never run the pump without water, as the water is necessary for cooling and lubrication of the mechanical shutter. Open all the suction and discharge pipe valves, and the filter air purge valve if there is one. (Any air in the suction pipes must be eliminated). Start up the generator and wait a reasonable time for priming. Five minutes is not excessive for priming (this time depends on the suction head and the length of the suction pipe). If the pump does not start or does not prime, please refer to the troubleshooting guide.

USING THE CONTROL PANEL

1. INTRODUCTION

Hayward®'s variable speed pump is operated through a control panel that visually displays the operating settings and allows you to adjust them as well as program the Timer mode.

1	Power on LED
2	LCD display screen
3	Choosing the speed
4	Switching between Manual/Timer modes
5	Up/down buttons
6	Start/Stop button
7	Display settings button
8	Selected speed LEDs

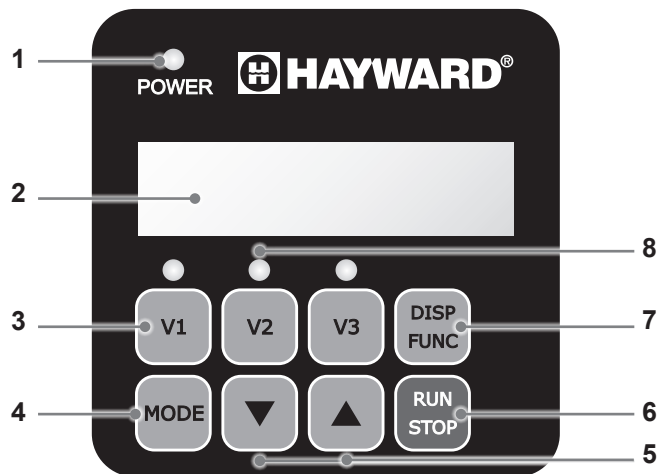

The pump is delivered with **DEFAULT SETTINGS**(factory settings):

Priming time (seconds)	Priming speed (rpm)	V1 (rpm)	V2 (rpm)	V3 (rpm)	Skimmer time (minutes)	Skimmer cycle (hours)	Skimmer speed (rpm)
240	3000	1500	2400	3000	15	1hr	2800

rpm: Rotations per minute

USE ONLY HAYWARD® GENUINE REPLACEMENT PARTS

2. PUMP OPERATING MODES

2.1 Manual mode

In manual mode, the user can switch the pump on or off manually, according to when the pool is being used.

- When you switch the pump on, it launches a priming phase (a). You can adjust this phase (speed and duration, section 4.2). Priming may be interrupted during start up (section 3.2) or deactivated in the settings.
- The pump speed then stabilizes to a constant rate (b) (stabilization to V2 by default). The user can choose and adjust the speed (section 3.3).
- After switching off and then restarting, the pump will stabilize at the last recorded rate.

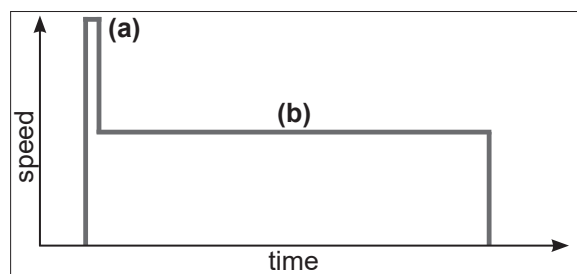

2.2 Skimmer

The Skimmer function allows the pump to skim just the water's surface, which is especially useful for preventing dirt from accumulating and stagnating at the surface of the pool.

- The function is automatic: the pump will run at a higher speed (c) for a while and according to a set cycle - both of which you can adjust.
- After running at a higher speed, the pump will adjust to its normal rate - this is the case in both the Manual and Timer modes.
- You can deactivate the Skimmer function (see settings in section 4.3).

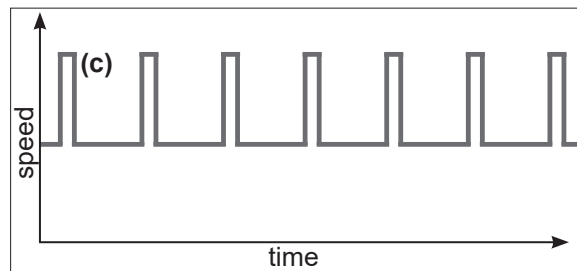

2.3 Timer mode

When using the Timer mode, the pump is run automatically 24/7. The user can program (d) the different speed presets. They are selected depending on the installation (heating mode, energy-saving mode etc.) and according to the times the pool is used.

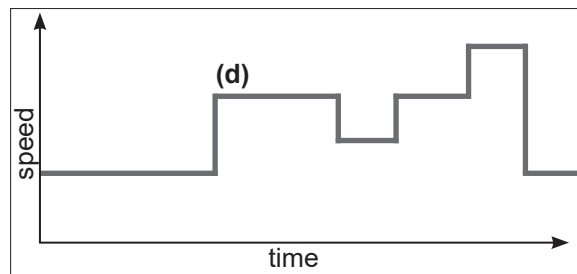

- If the Skimmer function is activated, its sequence will superimpose on the timer one.
- You can stop the pump (pause it) in the Timer mode. When you start it up again, it will run at the speed of the current 'Timer' mode.
- For information on how to program the Timer mode, see section 4.5.



2.4 Switching between Manual and Timer modes



You can switch between modes by pressing the button  as shown below:

Manual mode

Displayed speed without prefix  → 

The illuminated LED indicates the selected speed (V2 by default) 

Timer mode

Displayed speed with prefix 't'  → 

The LEDs are switched off 

2.5 Connecting external digital inputs

⚠ CAUTION: Before carrying out any electrical work on the pump, unplug the power cord and wait 5 min.

The filtration pump is equipped with a 3-m long 5-wire cord for connecting the 4 digital inputs or potential-free dry contacts (Open/Closed).

Examples of digital inputs

- Assign the speed and flow required for the peripheral devices, such as a heat pump, roller blind or robotic vacuum, etc. to work properly.
- Install a user interface control unit. These digital inputs are used to control, from a distance of 3 m, the Run/Stop function as well as the 3 speeds (V1-V2-V3).

Assigning the wires		
DI1	Brown	Speed V1
DI2	Green	Speed V2
DI3	White	Speed V3
DI4	Red	Run/Stop
C	Black	Common

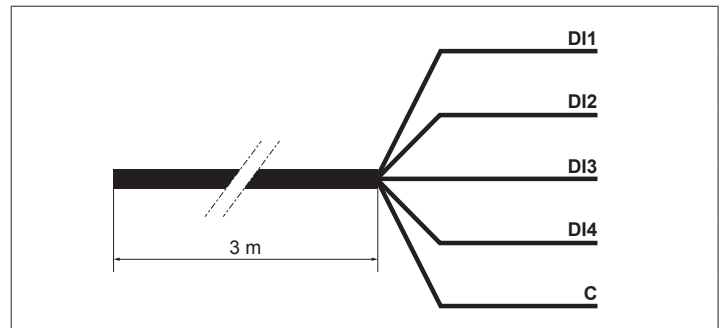

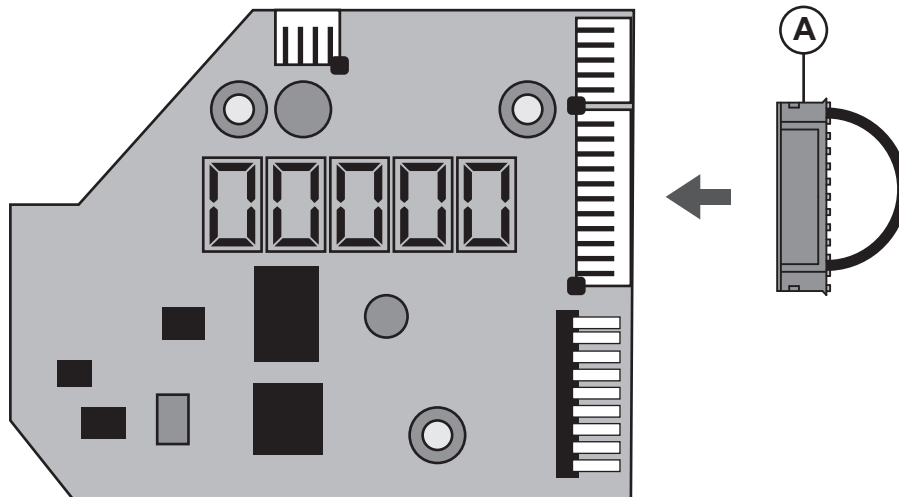

N.B.

- If the digital inputs are partially used, electrically insulate the unused wires.
- If the digital inputs are unused, insert the connector (A) instead of the 5-wire cord (see figure below).



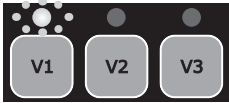

USE ONLY HAYWARD® GENUINE REPLACEMENT PARTS

Operation with the digital inputs

<p>The digital inputs can be operated in Manual or Timer mode. They have the highest priority level: they act as MASTER over all the functions currently in use. Only the Run/Stop and DISP/FUNC buttons remain active.</p>	 
<p>When a digital input is used, the LED associated with the speed in question blinks rapidly (DI1 = V1, DI2 = V2 or DI3 = V3).</p>	

<p>To obtain an action through the digital inputs, the DI4 input must be closed.</p>	 DI4 Run/StopClosed																
<p>If several digital inputs are switched simultaneously, only one will be carried out in the order of priority specified in the table opposite.</p>	<table border="1"> <thead> <tr> <th></th> <th>DI1 = V1</th> <th>DI2 = V2</th> <th>DI3 = V3</th> </tr> </thead> <tbody> <tr> <th>DI1 = V1</th> <td>V1</td> <td>V2</td> <td>V3</td> </tr> <tr> <th>DI2 = V2</th> <td>V2</td> <td>V2</td> <td>V3</td> </tr> <tr> <th>DI3 = V3</th> <td>V3</td> <td>V2</td> <td>V3</td> </tr> </tbody> </table>		DI1 = V1	DI2 = V2	DI3 = V3	DI1 = V1	V1	V2	V3	DI2 = V2	V2	V2	V3	DI3 = V3	V3	V2	V3
	DI1 = V1	DI2 = V2	DI3 = V3														
DI1 = V1	V1	V2	V3														
DI2 = V2	V2	V2	V3														
DI3 = V3	V3	V2	V3														

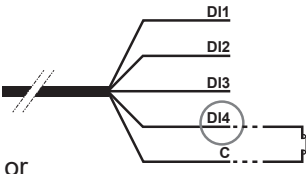
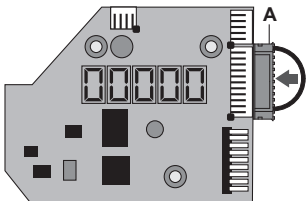
N.B. Once the action associated with the digital input is complete (open contact), the filtration pump resumes the action for the current operational mode.

<p>If the DI4 digital inlet is open, the filtration pump will not start and dSTOP will be displayed on the pump's screen.</p> <ul style="list-style-type: none"> • Close the DI4 inlet. • If necessary press RUN/STOP to start the filtration pump. 	  <p>or</p>  
---	---

3. OPERATING THE PUMP

3.1 Power on

'Power' lights up and an LCD test runs on screen, then the software version is displayed on screen

3.2 Priming phase

After switching on the pump, the priming phase starts automatically (this is the same after restarting the pump).

<p>Priming phase begins automatically:</p> <ul style="list-style-type: none"> The speed will climb to 3000 rpm and will last 240 seconds (default settings) 		→		
<p>End of priming phase:</p> <ul style="list-style-type: none"> The pump will stabilize at V2 by default or at the last recorded speed. The corresponding LED lights up (Manual mode) 		→		
<p>To display the remaining time of the priming phase:</p> <ul style="list-style-type: none"> Press DISP/FUNC The remaining time is displayed in seconds 		→		
<p>To stop the priming phase before it finishes:</p> <ul style="list-style-type: none"> Press RUN/STOP The speed will stabilize by default at V2 or at the last recorded speed 		→		

3.3 In Manual mode: selecting, setting and saving a custom speed

<p>To select a speed:</p> <ul style="list-style-type: none"> Press one of the speed preset buttons The default value will be displayed (in rpm) The corresponding LED will light up 		→		
<p>To set a new speed:</p> <ul style="list-style-type: none"> Press the up / down buttons The LED will blink: setting speed Choose the speed you want (between 600 and 3000 rpm) 		→		
<p>To save the new speed:</p> <ul style="list-style-type: none"> Press and hold the speed preset button for 3 s The LED will show a constant light once the speed has been saved 		→		

Note: The water flow generated by the pump speed must be adapted to the volume capacity of the installed parts (filter, pipes...). If you are unsure call a professional.











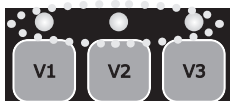

3.4 Stopping / restarting the pump

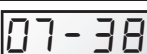
<p>To stop the pump:</p> <ul style="list-style-type: none"> Press RUN/STOP The pump will stop and the speed preset LED will remain illuminated In Manual mode the screen will display 'StoP' In Timer mode the screen will flash 'StoP' 		→		
<p>To restart the pump:</p> <ul style="list-style-type: none"> Press RUN/STOP The pump will begin its priming phase (section 3.2) Speed stabilization: 		→		
<ul style="list-style-type: none"> in Manual mode this will be the last recorded speed in Timer mode this will be the operating speed of the Timer preset 		→		

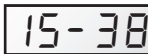











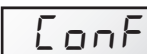
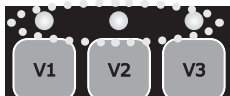







4. SETTINGS

Note: To adjust the settings the pump must be powered on and in **Manual mode** (section 2.4), switched off or running (post priming phase).
If no button is pressed for 2 minutes, the display will go back to normal (showing the speed or StoP) and the settings will not be saved.

4.1 Setting the clock

<ul style="list-style-type: none"> Press and hold DISP/FUNC for 3 seconds All three LEDs will blink The screen will display "ConF" and then "hr" 						
<ul style="list-style-type: none"> Press DISP/FUNC to show the time on the internal clock (hh-min) 						
<ul style="list-style-type: none"> Press the up / down buttons to adjust the hours / minutes 						
<ul style="list-style-type: none"> Press RUN/STOP to exit and save The display will show the current speed or StoP 						
<p>Note: Adjusting the time on the internal clock is important in Timer mode. It will remain saved if the pump is switched off.</p>						

4.2 Setting the priming phase

<ul style="list-style-type: none"> Press and hold DISP/FUNC for 3 seconds All 3 LEDs will blink and the screen will display "ConF" 					
<ul style="list-style-type: none"> Press DISP/FUNC repeatedly until 'Pr 240' is displayed on screen - the default priming time (seconds) 					
<ul style="list-style-type: none"> Press the up / down buttons to set the desired value (0 to 300 seconds) 					
<ul style="list-style-type: none"> Press DISP/FUNC: the screen will display "o3000" as default priming speed (rpm) 					
<ul style="list-style-type: none"> Press the up / down buttons to display the desired value (max. 3000 rpm) 					
<ul style="list-style-type: none"> Press RUN/STOP to exit and save The display will show the current speed or StoP 					
<p>Note: If the priming time is set to zero the screen will display "ProFF": priming has been deactivated</p>					

4.3 Setting the Skimmer function

See section 2.2 for an introduction to this function

<ul style="list-style-type: none"> Press and hold DISP/FUNC for three seconds All three LEDs will blink and the screen will display "ConF" 		→	ConF	
<ul style="list-style-type: none"> Press DISP/FUNC repeatedly until 'SFO.15' is displayed on screen: this is the default Skimmer time (in minutes) 		→	SFO.15	
<ul style="list-style-type: none"> Press the up / down buttons to set the desired value (0 to 30 minutes) 		→	SFO20	
<ul style="list-style-type: none"> Press DISP/FUNC: the screen will display "St 1hr" - this is the default Skimmer cycle period 		→	St 1h	
<ul style="list-style-type: none"> Press the up / down buttons to set the Skimmer cycle period to 1hr, 2hrs or 3hrs 		→	St 2h	
<ul style="list-style-type: none"> Press DISP/FUNC: the screen will display "S2800" - this is the default speed of the Skimmer function (rpm) 		→	S2800	
<ul style="list-style-type: none"> Press the up/down buttons to display the desired speed (600 to 3000 rpm) 		→	S2680	
<ul style="list-style-type: none"> Press RUN/STOP to exit and save The display will show the current speed or StoP 		→	1640 / StoP	
Note: To deactivate the Skimmer and set the time to zero - display reads "SFoFF"		→	SFoFF	

4.4 Restoring the settings

To restore the default settings and erase the Timer mode settings, do the following:

<ul style="list-style-type: none"> Press and hold DISP/FUNC for three seconds All three LEDs will blink and the screen will display "ConF" 		→	ConF	
<ul style="list-style-type: none"> Press DISP/FUNC repeatedly until the screen displays the message 'Init' 		→	Init	
<ul style="list-style-type: none"> Press and hold the 'up' button for 3 seconds. The screen will read "donE" once the reset is complete 		→	donE → StoP	

Reminder: default settings and their value ranges

	Priming		Speed preset buttons			Skimmer function			Timer function			
	Pr	o...	V1	V2	V3	SF	St	S...	t0	t1	t5	
Units	s	rpm	rpm	rpm	rpm	min	h	rpm	hh-min	rpm	hh-min	rpm
Default	240	3000	1500	2400	3000	15	1	2800	06-00	2400	oFF	0
Mini	0 (oFF)	600	600	600	600	0 (oFF)	1 ...	600	00-00	—	00-00	0/ 600
Maxi	300	3000	3000	3000	3000	30	... 3	3000	24-00	—	24-00	3000

USE ONLY HAYWARD® GENUINE REPLACEMENT PARTS

4.5 Setting the Timer mode

The control panel allows you to program multiple sequences (see section 2.3) or Timers t0 to t5, which do not need to follow a chronological order.

Unused Timer settings will be deactivated.

Timer 't0' can be set to 00:00, 06:00 (by default), 12:00 or 18:00. It cannot be deactivated.

You cannot adjust the speed of t0, it is set at 2400 rpm

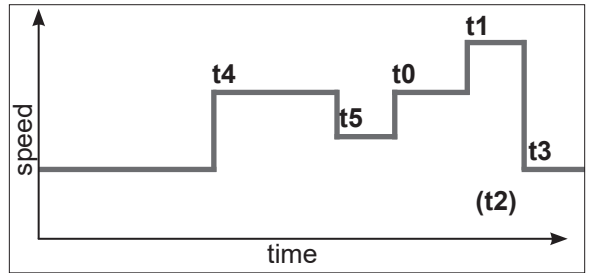















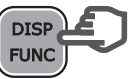

- Identify the speed profile you would like to program. The image opposite is shown as an example.
- Check whether the internal clock has been set correctly.

<ul style="list-style-type: none"> • Press and hold DISP/FUNC for 3 seconds All 3 LEDs will blink and the screen will display "ConF" 		→	ConF			
<ul style="list-style-type: none"> • Press DISP/FUNC twice and the screen will display "t0" 		→	t0			
<ul style="list-style-type: none"> • Press DISP/FUNC: the screen will display "06-00" - this is the default value of t0 		→	06-00			
<ul style="list-style-type: none"> • Press the up / down buttons to set the value you would like for t0 (00-00, 06-00, 12-00 or 18-00) 		→	18-00			
<ul style="list-style-type: none"> • Press DISP/FUNC: the screen will display "t1oFF" 		→	t1oFF			
<ul style="list-style-type: none"> • To activate this Timer setting (as an example), press the 'up' button. The screen will display "t1 on" 		→	t1 on			
<ul style="list-style-type: none"> • Press DISP/FUNC: the screen will display "00-00" 		→	00-00			
<ul style="list-style-type: none"> • Press the up / down buttons to set the desired timetable (hh-mm) 		→	20-00		→	20-15
<ul style="list-style-type: none"> • Press DISP/FUNC: the screen will display "0" 		→	0			
<ul style="list-style-type: none"> • Press the up / down buttons to display the desired speed (600 to 3000 rpm or 0) 		→	2740			
<ul style="list-style-type: none"> • To go to the next Timer setting, press DISP/FUNC: the screen will display "t2oFF". In this example the Timer setting stays deactivated 		→	t2oFF			
<ul style="list-style-type: none"> • Press DISP/FUNC to go to the next Timer setting and repeat the steps (activation, timetable, Timer setting and speed) 		→	t3oFF	etc ...		
<ul style="list-style-type: none"> • Press RUN/STOP to exit and save The display will show the current speed or StoP 		→	1640 / StoP			

USE ONLY HAYWARD® GENUINE REPLACEMENT PARTS

5. DISPLAYING CURRENT SETTINGS

Note: The pump must be switched on, either running (post priming phase) or stopped.
 To display the current settings, press DISP/FUNC.
 If no button is pressed for 15 seconds thereafter, the display will go back to normal (showing the current speed or Stop).

<ul style="list-style-type: none"> Press DISP/FUNC: the screen will display "hr" Press again: the screen will display the internal clock time 	 → hr	 → 11-45
<ul style="list-style-type: none"> Press DISP/FUNC: the screen will display "t0" Press again: the screen will display the 0t timetable (the t0 speed is fixed at 2400 rpm) 	 → t0	 → 12-00
<ul style="list-style-type: none"> Press DISP/FUNC: the screen will display "t1" Press again: the screen will display its timetable (hh-mm) 	 → t1	 → 09-20
<ul style="list-style-type: none"> Press DISP/FUNC: the screen will display the speed of the Timer setting (in rpm) 	 → 1240	
<ul style="list-style-type: none"> Press DISP/FUNC: the screen will display the next Timer setting, the timetable and the speed - you can do this up to Timer setting 't5' <p>Note: Deactivated Timer settings are not displayed</p>	 → t2	etc ...
<ul style="list-style-type: none"> Press DISP/FUNC: the screen will display "P- - - -" Power consumption (in Watts, a value of +/- 10%) <p>Note: P = 0 W when the pump is off.</p>	 → P 634 / P 0	
<ul style="list-style-type: none"> Press DISP/FUNC: the screen will display "h - - - -" The pump's operating hours counter <p>Note: The counter runs up to 9999 hours</p>	 → h2857	
<ul style="list-style-type: none"> Press DISP/FUNC: the screen will display "- - - - -" Total energy consumption (in kWh) <p>Note: The counter runs up to 99999 kWh</p>	 → 06542	
<ul style="list-style-type: none"> Press DISP/FUNC: the screen will display "- - - - -" Partial energy consumption (in kWh) since the last reset 	 → 00086	
<ul style="list-style-type: none"> To reset the partial energy consumption counter: Press and hold either of the up / down buttons for 3 seconds. The message "CLEAR" will be displayed, indicating that the counter has been reset to zero. 	   → CLEAR	
<ul style="list-style-type: none"> Press DISP/FUNC: The screen will display "SF On" or "SFOFF" to indicate that the Skimmer is on or off 	 → SF On / SFOFF	
<ul style="list-style-type: none"> Press DISP/FUNC: Screen displays "t - -" This is the temperature of the power module (in °C) 	 → t 74	
<ul style="list-style-type: none"> Press DISP/FUNC to exit back to the normal screen (showing current speed or Stop) 	 → 1640 / 5toP t2400 / :5toP	

USE ONLY HAYWARD® GENUINE REPLACEMENT PARTS

MAINTENANCE

1. Completely disconnect the pump from the mains power supply before opening the cover and cleaning the strainer. Clean the strainer basket regularly. Do not bang on the basket to clean it. Check the seal on the cover of the strainer and replace it if necessary.
2. The motor shaft is mounted on self-lubricating bearings which do not require any subsequent lubrication.
3. Keep the motor clean and dry and ensure the ventilation openings are not blocked.
4. The mechanical seal occasionally starts to leak and must then be changed.
5. Apart from cleaning the pool, all repairs, servicing and maintenance must be carried out by a Hayward®-approved agent or a qualified person.

Wear parts of the pump mentioned below should be maintained according to their estimated life:

Wear parts estimated life

Mechanical seal	1 year
Motor bearings kit	1 year
Set of gasket (strainer, housing, bulkheads, drain)	2 years
Capacitor	2 years

WINTERING

1. Empty the pump by removing all the drain plugs and store them in the strainer basket.
2. Disconnect the pump, remove the pipe connectors and store the entire unit in a dry, well-ventilated place or at least take the following precaution: disconnect the pump, remove the 4 bolts attaching the pump housing to the motor bracket and store the unit in a dry, well-ventilated place. Then cover the pump housing and strainer to protect them.

N.B.: Before recommissioning the pump, clean all the internal parts to remove dust, lime scale etc.

TROUBLESHOOTING

A) The motor does not start

1. Check the electrical connections, switches or relays, and the circuit breaker or fuses.
2. Ensure that the motor turns freely by hand.
3. Check that rotation speeds V1, V2 and V3 are not programmed at 0rpm. If they are, restore the factory settings (see section 4.4).
4. If the screen displays any of the error messages below, please contact your vendor:

Err01 Constant low line voltage	Err10 Internal problem with electrical supply
Err02 Constant high line voltage	Err20 Starting problems
Err04 Power module overheating	Err64 Internal short-circuiting problem
Err05 Motor overheating	Err97 Multiple problems
Err07 Overload	Err98 Communication problem
	dStoP Refer to page 21

B) The motor stops, check

1. The cables, connections, relays etc.
2. Voltage drop on motor (frequently caused by cables that are too small).
3. That there is no seizing or overheating (by reading the absorbed current).

N.B.: The motor on your pump is fitted with a thermal protection which, in the case of overload, will automatically cut the circuit and avoid the motor being damaged. This triggering is caused by abnormal usage conditions which need to be checked and corrected. The motor will restart without any intervention as soon as normal operating conditions are restored.

C) "OLOAD" appears on the display (overload or over-heating problem)

1. Check that the motor shaft turns freely
2. Check that no debris is preventing the turbine from rotating freely
3. Check that the motor is correctly ventilated
4. After correcting the problem, press the On/Off button

USE ONLY HAYWARD® GENUINE REPLACEMENT PARTS

D) The pump does not prime

1. Ensure the strainer housing is filled with water, that the cover seal is clean and correctly positioned and that no air can enter. If necessary, tighten the cover lock screws.
2. Ensure that all the suction and discharge valves are open and not blocked and that the suction outlets in the pool are fully submerged.
3. Check that the pump draws by freeing the suction as close as possible to the pump:
 - a) if the pump does not draw despite being sufficiently full of priming water
 1. Tighten the bolts and pipe accessories on the suction side.
 2. Check the voltage to ensure that the pump is rotating at the correct speed.
 3. Open the pump and check that nothing is blocking it inside,
 4. Set a priming speed that is fast enough
 5. Clean the filter and try again
 6. Replace the mechanical shutter.
 - b) Try priming in re-circulation mode. If the pump is drawing normally, check the suction pipe and strainer which may be blocked or be allowing air to enter.

E) Noisy pump, check

1. That no air is entering the suction side and causing dull crackling in the pump.
2. That there is no cavitation caused by insufficient diameter or a restriction in the suction tube. An over-sized discharge pipe can also cause cavitation. Use pipes of the correct size or purge the pipes if necessary.
3. That no vibration is occurring due to incorrect fitting.
4. That there are no foreign bodies in the pump housing.
5. That the motor bearings have not seized due to excessive clearance, rust or prolonged overheating.



HAYWARD®

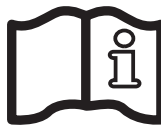
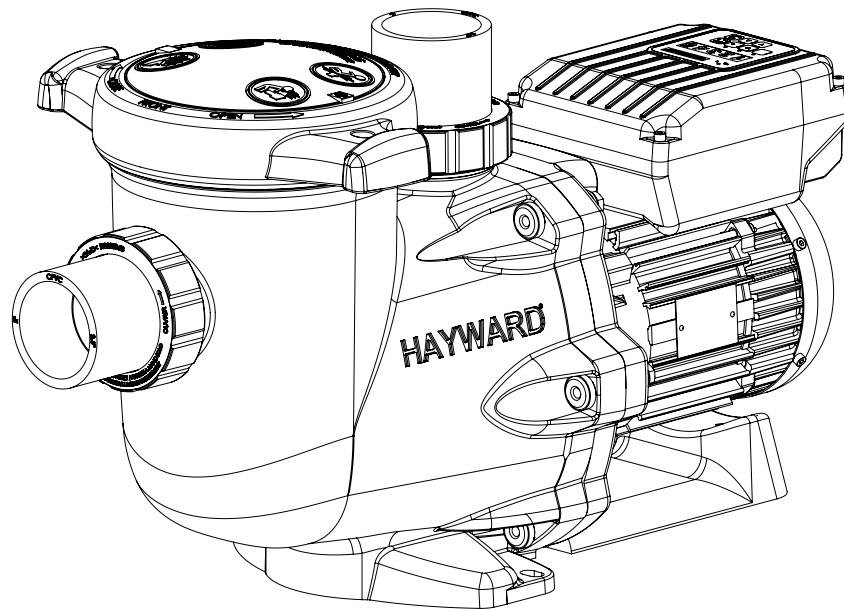

BOMBA CENTRÍFUGA DE VELOCIDAD VARIABLE

MANUAL DEL USUARIO

CONSERVE ESTE MANUAL PARA CONSULTARLO POSTERIORMENTE



**ADVERTENCIA: Peligro eléctrico. Un fallo en el seguimiento de las instrucciones puede dar como resultado una herida seria o la muerte.
PARA USO EN PISCINAS**

⚠ ADVERTENCIA – Antes de abrir la tapa para la limpieza del filtro, desconectar la bomba completamente del suministro de alimentación eléctrica.

⚠ ADVERTENCIA – Todas las conexiones eléctricas deben ser efectuadas por un electricista profesional autorizado cualificado y según las normas vigentes en el país de instalación, en su defecto, la Norma Internacional IEC 60364-7-70.

⚠ ADVERTENCIA – Asegúrese de que la máquina solamente se conecta a una toma de 230 V \surd protegida contra cortocircuitos. La bomba se alimentará por medio de un transformador aislante o a través de un dispositivo de corriente residual (DCR) con una corriente de funcionamiento residual nominal que no exceda de 30 mA.

⚠ ADVERTENCIA – Asegúrese de que los niños no jueguen con este aparato. Mantenga los dedos y objetos extraños lejos de las aberturas y las partes móviles.

⚠ ADVERTENCIA – El motor debe estar situado en el suelo adecuadamente. Conecte el cable de tierra al tornillo verde de la base y para las unidades conectadas con cable use correctamente la salida de tierra.

⚠ ADVERTENCIA – Utilice una agarradera de conexión al motor para conectar el motor con otras partes de conexión usando el conductor del tamaño apropiado como se especifica en los códigos eléctricos.

⚠ ADVERTENCIA – Cuando realice dichas conexiones eléctricas, revise el diagrama de debajo de la tapa de la caja del terminal del motor. Asegúrese de comprobar que las conexiones eléctricas están apretadas y selladas antes de conectarlas a la corriente. Retire todas las cubiertas antes de poner en funcionamiento.

⚠ ADVERTENCIA – Asegúrese que el voltaje del suministro eléctrico requerido por el motor corresponde al de la red de distribución y que los cables de suministro eléctrico corresponden a la potencia y la corriente de la bomba.

⚠ ADVERTENCIA – Leer y seguir todas las instrucciones contenidas en este manual del propietario e indicadas en el equipo. La inobservancia de las instrucciones puede causar lesiones corporales. Este documento debe entregarse al propietario de la piscina, el cual deberá conservarlo en un lugar seguro.

⚠ ADVERTENCIA – Los niños mayores de 8 años y personas sin el conocimiento o la experiencia necesarios o con discapacidades físicas, mentales o sensoriales pueden utilizar este aparato si han recibido las instrucciones apropiadas y comprenden los peligros que conlleva su uso. Los niños no deben jugar con el aparato. La limpieza y el mantenimiento del usuario no deberán ser realizados por niños, salvo que sean mayores de 8 años y estén supervisados. Mantenga el aparato y el cable fuera del alcance de niños menores de 8 años.

⚠ ADVERTENCIA – La bomba está diseñada para un funcionamiento continuo a temperatura de agua máxima de 35°C.

⚠ ADVERTENCIA – Use solo piezas de repuesto originales de Hayward®.

⚠ ADVERTENCIA – Si el cable de alimentación está dañado, debe ser sustituido por el fabricante, su distribuidor o personas cualificadas de forma similar, para evitar que se produzcan peligros.

⚠ ADVERTENCIA – Debe instalarse un interruptor externo con una separación de contactos en todos los polos que proporcione una desconexión completa en condiciones de sobretensión de categoría III en el cableado fijo que cumpla con las reglas de cableado para la desconexión del suministro de alimentación eléctrica.

⚠ ADVERTENCIA – No operar la bomba de la piscina si el cable de conexión o la carcasa de la caja de conexión del motor está averiada. Esto puede provocar una descarga eléctrica. Un cable de alimentación o una caja de conexión del motor dañados deben ser sustituidos por un técnico o una persona igualmente cualificada inmediatamente para evitar un peligro.

⚠ ADVERTENCIA – Este motor de piscina NO está equipado con un Sistema de seguridad de liberación del vacío (SSLV). El SSLV ayuda a prevenir ahogamientos a causa de atrapamientos del cuerpo en los drenajes sumergidos. En algunas configuraciones de piscinas, si el cuerpo de una persona cubre el drenaje, la persona puede quedar atrapada por succión. Dependiendo de la configuración de su piscina, puede ser necesario un SSLV para cumplir los requisitos de la normativa local

⚠ ADVERTENCIA – Esta bomba contiene una pila que por razones de seguridad, toda manipulación, debe ser realizada por un servicio técnico habilitado..

USE SOLO PIEZAS DE REPUESTO ORIGINALES DE HAYWARD®

GENERALIDADES

Le felicitamos por haber adquirido una bomba de velocidad variable Hayward®.

Las bombas de velocidad variable de Hayward® poseen un motor de imán permanente de conmutación electrónica AC de última generación. Este motor está dirigido por un microprocesador vinculado a un variador de frecuencia que permite las siguientes características:

- Visualización de la velocidad de rotación en la pantalla de control
- 3 velocidades de rotación predefinidas de fábrica (botones V1, V2, V3), velocidades ajustables por el usuario
- Cebado sistemático en cada arranque, velocidad y duración del cebado ajustables
- Función Skimmer, desespumado de la superficie del agua
- Función Timer ajustable
- Visualización de la potencia instantánea consumida
- Visualización del consumo de energía total y parcial
- Visualización del tiempo de funcionamiento de la bomba
- Nivel sonoro bajo
- Estándar de construcción TEFC IP55

Instalar la bomba a buena distancia de la piscina para reducir al máximo en enlace entre la aspiración y la bomba, esto con el fin de limitar las pérdidas de cargas inútiles y excesivas en el circuito hidráulico.

No obstante, deberá respetarse imperativamente una distancia de seguridad exigida por la norma de instalación vigente (3.5 metros como mínimo). Instale y use el producto a una altitud inferior a 2.000 m

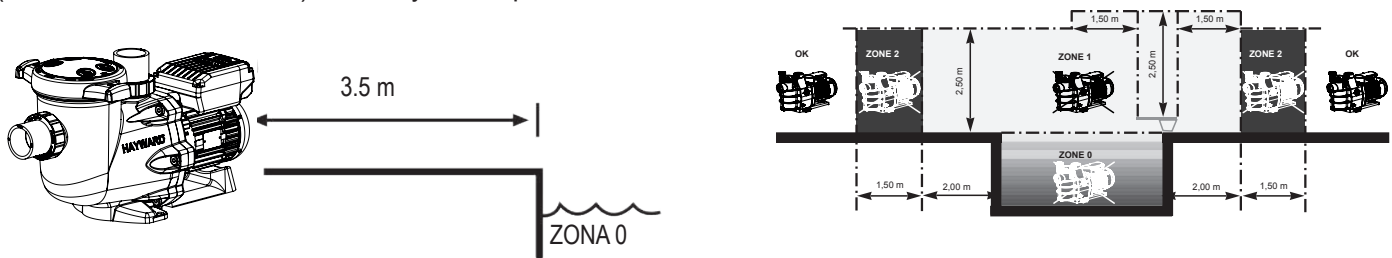

Instalar la bomba en un local ventilado y seco, el motor exige que el aire circule libremente alrededor de la bomba para que se ventile naturalmente. Prever un espacio libre de 0,5 m como mínimo alrededor de la bomba. Comprobar regularmente que no haya objetos, hojas o cualquier otro obstáculo que pudiese obstruir la refrigeración del motor. La bomba debe instalarse de modo que el interruptor exterior de desconexión que está integrado en la caja fija sea visible y fácilmente accesible. El interruptor debe estar situado cerca de la bomba.

La bomba debe instalarse permanentemente sobre un zócalo de hormigón con grapones de Ø 8 mm. adaptados al hormigón, atornillados en los emplazamientos donde se realizaron agujeros de implantación. Deben preverse arandelas de retención para impedir que se aflojen los grapones de montaje con el paso del tiempo. Si la bomba debe montarse sobre un suelo de madera, deben utilizarse tornillos de madera hexagonales de Ø 8 mm. adaptados a la madera - así como arandelas freno destinadas a impedir cualquier aflojamiento con el paso del tiempo.

Instalar la bomba al abrigo con el fin de no exponer la caja de control a fuertes proyecciones de agua.

La presión acústica de las bombas Hayward® es inferior a 70 dBA.

Disposiciones necesarias:

- Conectar la bomba a la tierra: No hacer nunca funcionar la bomba si no está conectada a la tierra.
- Conecte la bomba con un cable H07RN-F 3G1,5mm².
- Prever un dispositivo de protección diferencial 30 mA, destinado a proteger a las personas contra los choques eléctricos provocados por una eventual ruptura del aislamiento eléctrico del equipamiento.
- Prever una protección contra los cortocircuitos (la definición del calibre se hace en función del valor observado en la placa del motor).
- Prever un medio de desconexión de la red de alimentación que tenga una distancia de apertura de los contactos de todos los polos que garantice un corte completo en las condiciones de categoría de sobretensión III.

⚠ ATENCIÓN: Esperar 5 minutos después de haber desconectado completamente la bomba de la red eléctrica antes de intervenir en el motor o la caja de conexión: **Riesgo de choque eléctrico pudiendo ocasionar la muerte.**

Los motores eléctricos que equipan nuestras bombas tienen una protección térmica, esta protección reacciona en caso de una sobrecarga o calentamiento anormal del bobinado motor. Esta protección se rearma automáticamente cuando la temperatura del bobinado baja.

Si la reglamentación lo impone y cualquiera que sea el tipo de motor utilizado, es necesario, además de los dispositivos enumerados más arriba, instalar una protección magnetotérmica que debe calibrarse según las indicaciones de la placa motor. La tabla de la página 169 proporciona las distintas características del motor que equipan nuestras bombas.

USE SOLO PIEZAS DE REPUESTO ORIGINALES DE HAYWARD®

Conexión eléctrica: Asegurarse que la tensión de alimentación exigida por el motor corresponde a la de la red de distribución y que la sección y longitud del cable de alimentación se adaptan a la potencia y tiene la intensidad de la bomba.

El conjunto de las conexiones eléctricas de la bomba, así como el eventual cambio del cable de alimentación debe realizarlo un profesional cualificado con el fin de evitar cualquier tipo de peligro.

Para realizar estas conexiones eléctricas, respetar el marcado inscrito debajo de los terminales de conexión.

Comprobar debidamente la sujeción y la estanqueidad de las conexiones eléctricas antes de la puesta bajo tensión.

Respetar correctamente el paso del cable por el orificio y ferrita prevista a tal efecto; garantizando la estanqueidad alrededor del cable, la ferrita constituye un filtro para las perturbaciones electromagnéticas.

El precableado que equipa algunas de nuestras bombas debe retirarse durante la conexión definitiva de la bomba a la alimentación eléctrica. En efecto este pre-equipamiento sólo se utiliza para los tests en fábrica durante las fases de fabricación.

INSTALACIÓN

Instalar la bomba de la piscina limitando al máximo las pérdidas de cargas y respetando al mismo tiempo las condiciones de alejamiento, 3,5 m como mínimo según la norma de instalación. El conducto de aspiración debe instalarse con poca pendiente ascendente hacia el eje de la bomba. Asegurarse que las conexiones estén bien prietas y sean estancas. No obstante, evitar bloquear estas tuberías de modo exagerado. Para las materias plásticas, asegurar la estanqueidad con Teflón únicamente. El tubo de aspiración tendrá un diámetro mayor o al menos igual al de la descarga. Evitar emplazamientos no ventilados o húmedos. El motor exige que el aire de refrigeración pueda circular libremente. Instalar la bomba al abrigo con el fin de no exponer la caja de control a fuertes proyecciones de agua.

INSTRUCCIONES DE ARRANQUE Y CEBADO: Llenar de agua el cuerpo del pre-filtro hasta el nivel del tubo de aspiración. No hacer funcionar nunca la bomba sin agua, este agua es necesaria para la refrigeración y la lubricación del obturador mecánico. Abrir todas las válvulas de los conductos de aspiración y descarga, así como la purga de aire del filtro si está previsto. (Toda presencia de aire en los conductos de aspiración deberá eliminarse). Arrancar el grupo y esperar un tiempo razonable para el cebado. Cinco minutos no es un plazo de tiempo exagerado para cebar (este cebado depende de la altura de aspiración y la longitud del tubo de aspiración). Si la bomba no arranca o no se ceba consultar la guía de búsqueda de las averías.

USO DE LA CAJA DE MANDOS

1. PRESENTACIÓN

La bomba con velocidad variable Hayward® está controlada por una caja de mandos que permite visualizar los parámetros de funcionamiento, ajustarlos y programar el modo Timer.

1	Testigo LED de conexión
2	Pantalla de visualización LCD
3	Selección de la velocidad
4	Cambio entre modo Manual / modo Timer
5	Botones de ajuste arriba/abajo
6	Botón de Inicio/Parada
7	Botón de visualización de los parámetros
8	Testigos LED para la velocidad seleccionada

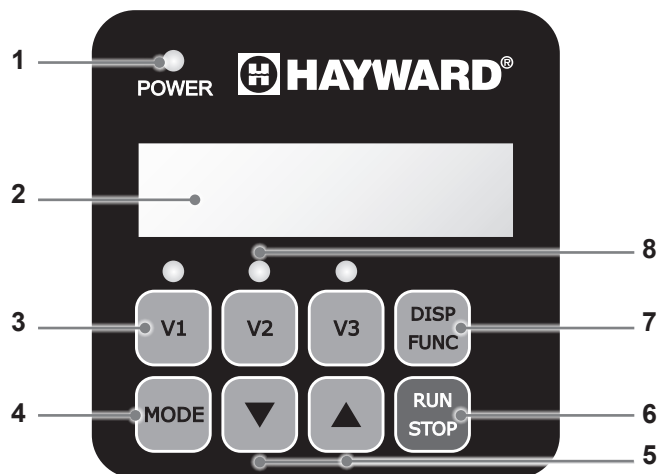

La bomba se suministra con **PARÁMETROS PREDETERMINADOS** (ajustes de fábrica):

Cebado duración	Cebado velocidad (rpm)	V1 (rpm)	V2 (rpm)	V3 (rpm)	Skimmer duración (min)	Skimmer ciclo (h)	Skimmer velocidad (rpm)
240	3 000	1500	2400	3000	15	1 h	2800

rpm: revoluciones por minuto

USE SOLO PIEZAS DE REPUESTO ORIGINALES DE HAYWARD®

2. MODOS DE FUNCIONAMIENTO DE LA BOMBA

2.1 Modo Manual

En modo Manual, el usuario arranca o detiene la bomba de forma manual, en función del uso de la piscina.

- El arranque de la bomba inicia un fase de cebado **(a)**. Esta fase es ajustable (velocidad y duración, § 4.2). El cebado puede interrumpirse en el arranque (§ 3.2) o desactivarse en los ajustes.
- La velocidad de la bomba se estabiliza después con un valor constante **(b)** (de forma predeterminada, estabilización con velocidad V2). El usuario puede seleccionar y ajustar esta velocidad (§ 3.3).
- Tras un inicio/parada, la bomba se estabilizará con la última velocidad guardada.

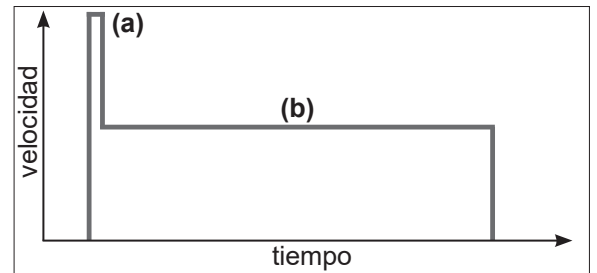

2.2 Skimmer

La función Skimmer permite desespumar la superficie del agua, especialmente evitar la acumulación y el estancamiento de suciedad en la superficie de la piscina.

- Esta función es automática: la bomba funciona con una velocidad más elevada **(c)** durante un tiempo y según un ciclo ajustables.
- Además de este aumento de velocidad, la bomba recobra su velocidad normal, independientemente del modo Manual o modo Timer.
- La función Skimmer puede desactivarse (consultar ajustes § 4.3).

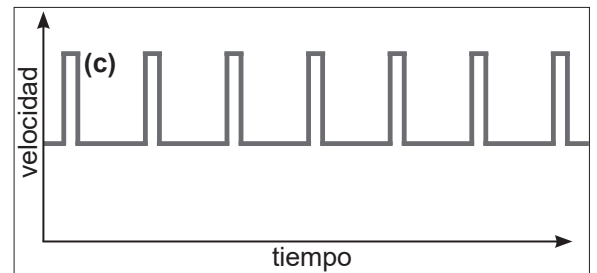

2.3 Modo Timer

En modo Timer, el funcionamiento de la bomba está automatizado las 24 horas del día. El usuario debe programar las diferentes secuencias de velocidad **(d)**. Se elegirán en función de la instalación (modo de calentamiento, ahorro de energía, etc.) y de los horarios de uso de la piscina.

- Si la función Skimmer está activada, se superpone a estas secuencias.
- La bomba puede detenerse (ponerse en pausa) en modo Timer. Al arrancar de nuevo, la velocidad será la del Timer en curso.
- Para programar el modo Timer, consulte § 4.5.

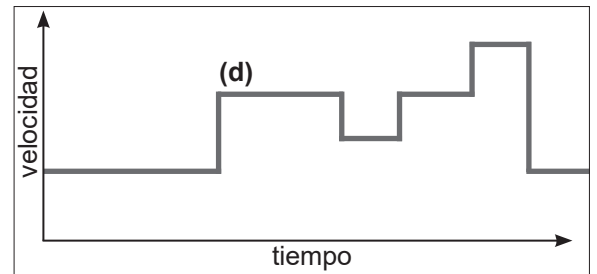

2.4 Cambio entre modo Manual / modo Timer

El cambio de modo se realiza pulsando el botón **MODE** tal como se ilustra a continuación:

Modo Manual

Visualización de la velocidad sin prefijo

El LED encendido indica la velocidad seleccionada (V2 de forma predeterminada)

Modo Timer

Visualización de la velocidad con prefijo «t»

Los LED están apagados

2.5 Conexión de las entradas digitales externas

⚠ ATENCIÓN: Antes de cualquier intervención eléctrica en la bomba, desconéctela de la red y espere 5 min.

La bomba de filtración dispone de un cable de 5 hilos de una longitud de 3 m que permite la conexión de 4 entradas digitales o contactos secos libres de potencial (Abierto/Cerrado).

Ejemplos de uso de las entradas digitales

- Asigne la velocidad y el caudal necesarios al buen funcionamiento de los órganos periféricos tales como una bomba de calor, una persiana enrollable, un robot de aspiración, etc.
- Instale un recordatorio de orden en la interfaz del usuario. Estas entradas digitales permiten controlar a una distancia de 3 m la función de Run/Stop, así como las 3 velocidades (V1-V2-V3).

Asignación de los hilos		
DI1	Marrón	Velocidad V1
DI2	Verde	Velocidad V2
DI3	Blanco	Velocidad V3
DI4	Rojo	Run/Stop
C	Negro	Común

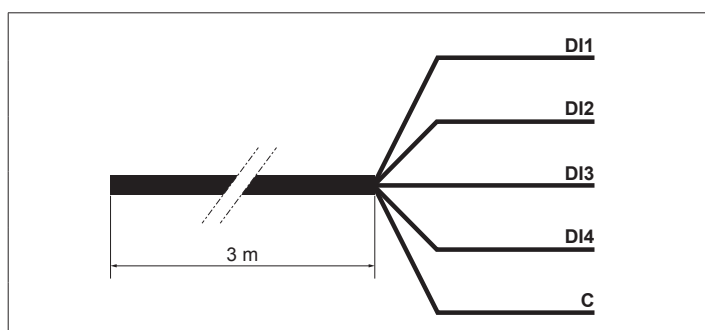

Nota:

- En caso de uso parcial de las entradas digitales, aisle eléctricamente los hilos no usados.
- En caso de no usar las entradas digitales, introduzca el conector (A) en el lugar del cable de 5 hilos (véase figura siguiente).

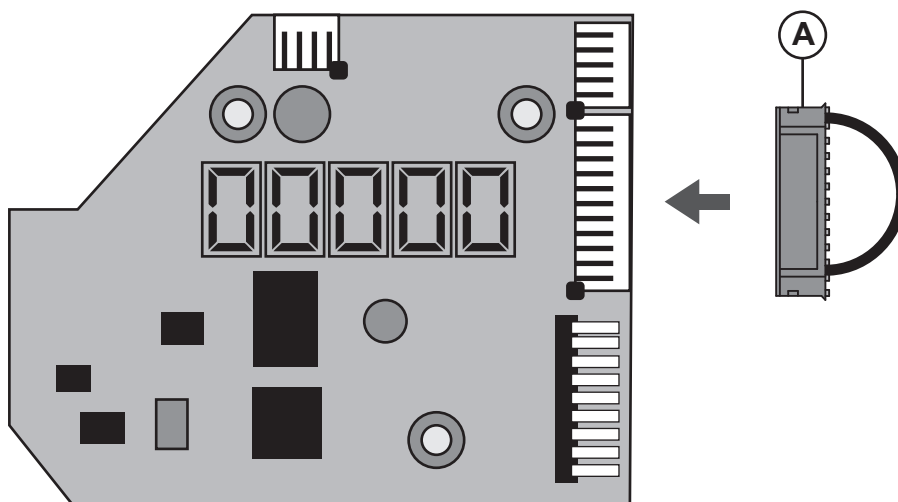

USE SOLO PIEZAS DE REPUESTO ORIGINALES DE HAYWARD®

Funcionamiento con las entradas digitales

<p>Las entradas digitales se pueden usar en modo Manual o en modo Temporizador (Timer). Tienen el nivel de prioridad más alto: son PRIORITARIAS ante todas las funciones en curso de uso. Sólo los botones Run/Stop y DISP/FUNC siguen activos.</p>	→	
	→	
<p>Cuando se usa una entrada digital, el LED asociado a la velocidad implicada parpadea rápidamente (DI1 = V1, DI2 = V2 o DI3 = V3).</p>	→	

<p>Para obtener una acción mediante las entradas digitales, la entrada DI4 debe estar cerrada.</p>	→	DI4 Run/StopCerrada		
<p>Si se conmutan varias entradas digitales simultáneamente, sólo una se ejecutará según el orden de prioridad definido en la tabla contigua.</p>		DI1 = V1	DI2 = V2	DI3 = V3
	DI1 = V1	V1	V2	V3
	DI2 = V2	V2	V2	V3
	DI3 = V3	V3	V2	V3

Nota: Una vez finalizada la acción asociada a la entrada digital (contacto abierto), la bomba de filtración retoma la acción del modo de funcionamiento en curso.

<p>Si la entrada digital DI4 está abierta, la bomba de filtración no arranca y dSTOP aparece en la pantalla de la bomba.</p> <ul style="list-style-type: none"> • Cierre la entrada DI4. • Eventualmente pulse RUN/STOP para arrancar la bomba de filtración. 	→	
	→	
	→	

3. USO

3.1 Conexión







El testigo «Power» se enciende, la pantalla realiza una prueba LCD y después muestra la versión del software

→



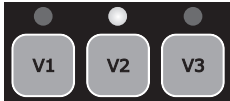



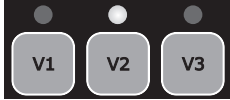

→

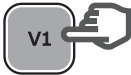
3.2 Fase de cebado

Tras la conexión de la bomba, la fase de cebado se inicia automáticamente (al igual que tras un reinicio de la bomba).



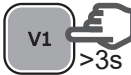



<p>Inicio automático de la fase de cebado:</p> <ul style="list-style-type: none"> • La velocidad aumenta hasta 3000 rpm y se mantiene durante 240 s (valores predeterminados) 	 → 	
<p>Final de la fase de cebado:</p> <ul style="list-style-type: none"> • De forma predeterminada, la velocidad se estabiliza en V2 o en la última velocidad guardada • El LED correspondiente se enciende (modo Manual) 	→ 	
<p>Para visualizar el tiempo de cebado restante:</p> <ul style="list-style-type: none"> • Pulse DISP/FUNC • El tiempo restante se visualiza en s 	 → 	
<p>Para salir antes del final de la fase de cebado:</p> <ul style="list-style-type: none"> • Pulse RUN/STOP • De forma predeterminada, la velocidad se estabiliza en V2 o en la última velocidad guardada 	 → 	

3.3 En modo Manual: selección, ajuste y guardar una velocidad

<p>Para seleccionar una velocidad:</p> <ul style="list-style-type: none"> • Pulse uno de los botones de velocidad • El valor predeterminado se visualiza (en rpm) • El LED correspondiente se enciende 	 → 	
<p>Para ajustar un nuevo valor de velocidad:</p> <ul style="list-style-type: none"> • Pulse los botones de ajuste arriba/abajo • El LED parpadea: ajuste en curso • Ajuste el valor deseado (de 600 a 3 000 rpm) 	 → 	
<p>Para guardar un nuevo valor de velocidad:</p> <ul style="list-style-type: none"> • Pulse durante 3 s el botón de velocidad • El LED pasa a fijo cuando la velocidad está guardada 	 → 	

Nota: El flujo de agua generado por la velocidad de la bomba debe adaptarse a la capacidad de la instalación (filtro, tuberías...). En caso de duda, consulte con un profesional.

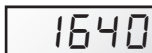
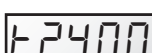
3.4 Parada/reinicio de la bomba













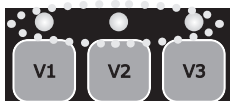

<p>Para detener la bomba:</p> <ul style="list-style-type: none"> • Pulse RUN/STOP • La bomba se detiene, el LED de velocidad permanece encendido • En modo Manual, la pantalla muestra «StoP» de forma fija ; En modo Timer, la pantalla muestra «StoP» de forma intermitente 	 → 	
<p>Para reiniciar la bomba:</p> <ul style="list-style-type: none"> • Pulse RUN/STOP • La bomba arranca en fase de cebado (§ 3.2) • La velocidad se estabiliza: en modo Manual con el último valor guardado, en modo Timer con la velocidad según el Timer en curso 	 →  → 	 

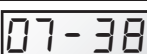
USE SOLO PIEZAS DE REPUESTO ORIGINALES DE HAYWARD®

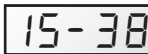









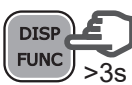

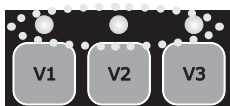

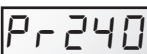





4. AJUSTES

Nota: Para acceder a los ajustes, la bomba debe estar conectada y en modo Manual (§ 2.4), detenida o en funcionamiento, pero no en la fase de cebado.
Si no se pulsa ningún botón durante 2 min, la pantalla vuelve a la visualización normal (velocidad o StoP) y los ajustes no se guardan.

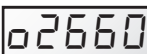
4.1 Ajuste del reloj

<ul style="list-style-type: none"> • Pulse durante 3 s DISP/FUNC Los 3 LED parpadean • La pantalla muestra «ConF», y después, «hr» 						
<ul style="list-style-type: none"> • Pulse DISP/FUNC, la pantalla muestra la hora del reloj interno (hh-min) 						
<ul style="list-style-type: none"> • Pulse los botones de ajuste abajo/arriba para ajustar las horas/minutos 						
<ul style="list-style-type: none"> • Pulse RUN/STOP para salir y guardar La visualización indica la velocidad en curso o StoP 						
<p>Nota: El ajuste del reloj interno es importante si la bomba funciona en modo Timer. Permanece guardado cuando la bomba se desconecta.</p>						

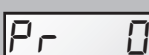
4.2 Ajuste del cebado

<ul style="list-style-type: none"> • Pulse durante 3 s DISP/FUNC Los 3 LED parpadean y la pantalla muestra «ConF» 				
<ul style="list-style-type: none"> • Pulse DISP/FUNC varias veces hasta que aparezca la pantalla «Pr 240», duración predeterminada del cebado (s) 				
<ul style="list-style-type: none"> • Pulse los botones de ajuste arriba/abajo para visualizar la duración deseada (de 0 s a 300 s) 				
<ul style="list-style-type: none"> • Pulse DISP/FUNC: la pantalla muestra «o3000» velocidad predeterminada de cebado (rpm) 				
<ul style="list-style-type: none"> • Pulse los botones de ajuste arriba/abajo para visualizar el valor deseado (máx. 3 000 rpm) 				
<ul style="list-style-type: none"> • Pulse RUN/STOP para salir y guardar La visualización indica la velocidad en curso o StoP 				
<p>Nota: Si la duración de cebado es de cero, la visualización muestra «ProFF»: el cebado está desactivado</p>				

4.3 Ajuste de la función Skimmer

Consulte el § 2.2 para la presentación de esta función

<ul style="list-style-type: none"> Pulse durante 3 s DISP/FUNC : los 3 LED parpadean y la pantalla muestra «Conf» 		→	Conf	
<ul style="list-style-type: none"> Pulse DISP/FUNC varias veces hasta que aparezca la pantalla «SFO.15»: duración predeterminada de la activación del Skimmer 		→	SFO.15	
<ul style="list-style-type: none"> Pulse los botones de ajuste arriba/abajo para visualizar la duración deseada (de 0 a 30 min) 		→	SFO20	
<ul style="list-style-type: none"> Pulse DISP/FUNC: aparece en la pantalla «St 1h»: duración predeterminada del ciclo Skimmer 		→	St 1h	
<ul style="list-style-type: none"> Pulse los botones de ajuste para ajustar el ciclo Skimmer a 1 h, 2 h o 3 h 		→	St 2h	
<ul style="list-style-type: none"> Pulse DISP/FUNC: la pantalla muestra «S2800»: velocidad predeterminada del skimmer (rpm) 		→	S2800	
<ul style="list-style-type: none"> Pulse los botones de ajuste arriba/abajo para visualizar la duración deseada (de 600 a 3 000 rpm) 		→	S2680	
<ul style="list-style-type: none"> Pulse RUN/STOP para salir y guardar La visualización indica la velocidad en curso o StoP 		→	1640 / StoP	
Nota: Para desactivar el Skimmer, ponga su duración a cero: la visualización pasa a «SFoFF»		→	SFO00 → SFoFF	

4.4 Reinicio de los parámetros

Para restaurar los parámetros de fábrica y borrar los ajustes del modo Timer, proceda de la manera siguiente:

<ul style="list-style-type: none"> Pulse durante 3 s DISP/FUNC Los 3 LED parpadean y la pantalla muestra «Conf» 		→	Conf	
<ul style="list-style-type: none"> Pulse DISP/FUNC varias veces hasta que aparezca «Init» en la pantalla 		→	Init	
<ul style="list-style-type: none"> Pulse el botón de ajuste «arriba» durante 3 s. La visualización pasa a «donE» cuando se realiza el reinicio 		→	donE → StoP	

Recordatorio: parámetros predeterminados e intervalos de ajuste

	Cebado		Botones velocidad			Función Skimmer			Función Timer			
	Pr	o...	V1	V2	V3	SF	St	S...	t0	rpm	t1 - t5	rpm
Unidad	s	rpm	rpm	rpm	rpm	min	h	rpm	hh-min	rpm	hh-min	rpm
Predeterminado	240	3000	1500	2400	3000	15	1	2800	06-00	2400	oFF	0
Mini	0 (oFF)	600	600	600	600	0 (oFF)	1 ...	600	00-00	—	00-00	0 / 600
Maxi	300	3000	3000	3000	3000	30	... 3	3000	24-00	—	24-00	3000

USE SOLO PIEZAS DE REPUESTO ORIGINALES DE HAYWARD®

4.5 Programación del modo Timer

La caja de mandos permite programar varias secuencias (consulte § 2.3) o Timers t0 a t5, que no tienen por qué seguir el orden cronológico.

Los Timers que no se usen se desactivarán.

El Timer «t0» puede fijarse a 00:00, 06:00 (predeterminado); 12:00 o 18:00. No puede desactivarse.

La velocidad del segmento t0 no se puede ajustar, está fijada en 2 400 rpm

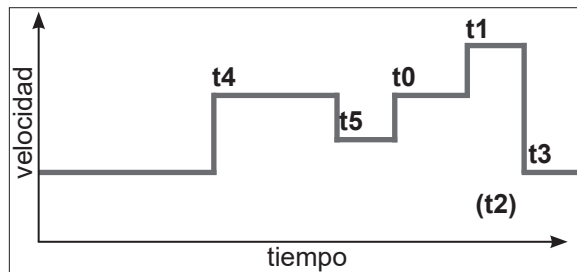

















- Defina el perfil de velocidad que desea programar. El gráfico contiguo se indica a modo de ejemplo.
- Compruebe que el reloj interno esté correctamente ajustado.

<ul style="list-style-type: none"> • Pulse durante 3 s DISP/FUNC Los 3 LED parpadean y la pantalla muestra «ConF» 		→				
<ul style="list-style-type: none"> • Pulse DISP/FUNC 2 veces hasta que salga «t0» 		→				
<ul style="list-style-type: none"> • Pulse DISP/FUNC: la pantalla muestra «06-00»: valor predeterminado de t0 		→				
<ul style="list-style-type: none"> • Pulse los botones de ajuste para fijar el t0 deseado (00-00, 06-00, 12-00 o 18-00) 		→				
<ul style="list-style-type: none"> • Pulse DISP/FUNC: la pantalla muestra «t1oFF» 		→				
<ul style="list-style-type: none"> • Para activar este Timer (ejemplo), pulse el botón «arriba». La pantalla muestra «t1 on» 		→				
<ul style="list-style-type: none"> • Pulse DISP/FUNC: la pantalla muestra «00-00» 		→				
<ul style="list-style-type: none"> • Pulse los botones de ajuste abajo/arriba para ajustar el horario deseado (hh-mm) 		→			→	
<ul style="list-style-type: none"> • Pulse DISP/FUNC: la pantalla muestra «0» 		→				
<ul style="list-style-type: none"> • Pulse los botones de ajuste para visualizar la duración deseada (de 600 a 3 000 rpm o cero) 		→				
<ul style="list-style-type: none"> • Para pasar al Timer siguiente, pulse DISP/FUNC: la pantalla muestra «t2off». En el ejemplo, este Timer permanece desactivado 		→				
<ul style="list-style-type: none"> • Pulse DISP/FUNC para pasar al Timer siguiente y repita las etapas de ajuste (activación, horario Timer y velocidad) 		→		etc ...		
<ul style="list-style-type: none"> • Pulse RUN/STOP para salir y guardar. La visualización indica la velocidad en curso o StoP 		→				

USE SOLO PIEZAS DE REPUESTO ORIGINALES DE HAYWARD®

5. VISUALIZACIÓN DE LOS PARÁMETROS

Nota: La bomba debe estar conectada, en marcha, pero no en fase de cebado o detenida.
 Para que desfilen los parámetros, pulse la tecla DISP/FUNC.
 Si no se pulsa ninguna tecla durante 15 s, la pantalla vuelve a la visualización normal (velocidad en curso o StoP).

<ul style="list-style-type: none"> Pulse DISP/FUNC: la pantalla muestra «hr» Pulse de nuevo: visualización de la hora interna 	 → hr  → 11-45
<ul style="list-style-type: none"> Pulse DISP/FUNC: la pantalla muestra «t0» Pulse de nuevo: visualización del horario del t0 (la velocidad del t0 está fijada en 2 400 rpm) 	 → t0  → 12-00
<ul style="list-style-type: none"> Pulse DISP/FUNC: la pantalla muestra «t1» Pulse de nuevo: visualización del horario de este Timer (hh-mm) 	 → t1  → 09-20
<ul style="list-style-type: none"> Pulse DISP/FUNC: visualización de la velocidad de este Timer (en rpm) 	 → 1240
<ul style="list-style-type: none"> Pulse DISP/FUNC etc.: visualización de los Timers siguientes, horario y velocidad, hasta el Timer «t5» <p>Nota: Los Timers desactivados no se visualizan</p>	 → t2 etc ...
<ul style="list-style-type: none"> Pulse DISP/FUNC: visualización «P - - - -» Potencia consumida (en W, valor de +/- 10 %) <p>Nota: P = 0 W cuando la bomba está detenida</p>	 → P 634 / P 0
<ul style="list-style-type: none"> Pulse DISP/FUNC: visualización «h - - - -» Contador horario de la bomba <p>Nota: Un giro completo del contador representa 9 999 h</p>	 → h2857
<ul style="list-style-type: none"> Pulse DISP/FUNC: visualización «- - - - -» Consumo total de energía (en kWh) <p>Nota: Un giro completo del contador representa 99 999 kWh</p>	 → 06542
<ul style="list-style-type: none"> Pulse DISP/FUNC: visualización «- - - - -» Consumo parcial de energía (en kWh), desde la última puesta a cero 	 → 00086
<ul style="list-style-type: none"> Para volver a poner a cero el contador parcial de energía: Pulse 3 s uno de los botones arriba/abajo. El mensaje «CLEAR» indica que el contador se ha puesto a cero 	  >3s → CLEAR
<ul style="list-style-type: none"> Pulse DISP/FUNC: Visualización «SF On» o «SFOFF» para Skimmer activado/desactivado 	 → SF On / SFOFF
<ul style="list-style-type: none"> Pulse DISP/FUNC: Visualización «t - - -» Temperatura del módulo de potencia (en °C) 	 → t 74
<ul style="list-style-type: none"> Pulse DISP/FUNC para volver a la visualización normal (velocidad en curso o StoP) 	 → 1640 / StoP t2400 / StoP

USE SOLO PIEZAS DE REPUESTO ORIGINALES DE HAYWARD®

MANTENIMIENTO

1. Desconecte completamente la bomba de la alimentación sector antes de abrir la tapa y limpiar el prefiltro. Limpiar la cesta del prefiltro regularmente, no golpear la cesta para limpiarla. Comprobar la junta de la tapa del prefiltro y cambiarla si fuera necesaria.
2. El eje de motor está montado sobre rodamientos autolubrificantes que no requieren ninguna lubricación posterior.
3. Guardar el motor limpio y seco y asegurarse de que los orificios de ventilación no tengan nada que los obstruya.
4. De vez en cuando el cierre mecánico puede acusar una fuga y deberá entonces sustituirse.
5. Con excepción de la limpieza de la piscina, todas las operaciones de reparación, mantenimiento o conservación deben ser efectuadas imperativamente por un inspector autorizado por Hayward® o una persona cualificada.

Las piezas de desgaste de la bomba que se mencionan a continuación deben revisarse de acuerdo con su vida útil estimada:

Vida estimada de las piezas de desgaste:

Cierre mecánico	1 año
Kit de rodamientos de motor	1 año
Kit de juntas (prefiltro, cuerpo, racores, desagüe)	2 años
Condensador	2 años

INVERNADA

1. Vaciar la bomba retirando todos los tapones de vaciado y conservarlos en la cesta del filtro.
2. Desconectar la bomba, retirar los empales de las tuberías y conservar el grupo completo en un lugar seco y ventilado o al menos tomar la siguiente precaución: desconectar la bomba, retirar los 4 tornillos de fijación del cuerpo de bomba al soporte del motor y conservar el conjunto en un lugar seco y ventilado. Seguidamente, cubrir el cuerpo de bomba y de prefiltro para protegerlos.

NOTA: Antes de volver a poner la bomba en servicio, limpiar todas las partes internas retirando el polvo, el calcáreo, etc.

EVENTUALES AVERÍAS Y SOLUCIONES

A) El motor no arranca

1. Comprobar las conexiones eléctricas, los interruptores o relés, así como el cortacircuitos o fusibles.
2. Asegurarse manualmente de la libre rotación del motor.
3. Comprobar que las velocidades de rotación V1 V2 y V3 no estén programadas a 0 r.p.m., cuando proceda proceder a una reinicialización de los parámetros fábrica (consulte § 4.4).
4. Si la pantalla muestra uno de los códigos de error siguientes, póngase en contacto con su instalador:

Err01	Subtensión de la línea continua	Err10	Problema de alimentación eléctrica interno
Err02	Sobretensión de la línea continua	Err20	Fallos de arranque
Err04	Sobrecalentamiento del módulo de potencia	Err64	Problema de cortocircuito interno
Err05	Sobrecalentamiento del motor	Err97	Problema múltiple
Err07	Sobreintensidad	Err98	Problema de comunicación
		dStop	Consulte la página 35

B) El motor se para, comprobar

1. Los cables, conexiones, relés, etc.
2. La caída de tensión al motor (frecuentemente causada por cables débiles)
3. Que no aparezca ningún gripado o sobrecarga (por lectura del amperaje absorbido)

NOTA: El motor de su bomba está equipado de una protección térmica que, en caso de sobrecarga, cortará automáticamente el circuito y evitará que el motor no se deteriore. Este desenganche está causado por condiciones anormales de utilización que es necesario comprobar y corregir. El motor volverá a arrancar sin ninguna intervención en cuanto se restablezcan las condiciones normales de funcionamiento.

C) «OLOAD» aparece en el visualizador (problema de sobrecarga o recalentamiento)

1. Comprobar que el árbol motor gire libremente
2. Comprobar que ningún residuo obstruya la libre rotación de la turbina
3. Comprobar que el motor esté ventilado correctamente
4. Después de haber solucionado el problema pulse el botón Marcha/Parada

USE SOLO PIEZAS DE REPUESTO ORIGINALES DE HAYWARD®

D) La bomba no se ceba

1. Asegurarse que el cuerpo del prefiltro esté bien lleno de agua, que la junta de la tapa esté limpia y bien colocada y que no sea posible ninguna entrada de aire. Si fuera necesario, apretar los tornillos de bloqueo de la tapa
2. Asegurarse de que todas las válvulas de aspiración y descarga están abiertas y no bloqueadas, y que todas las bocas de aspiración de la piscina estén bien sumergidas.
3. Comprobar si la bomba aspira liberando la aspiración lo más cerca posible de la bomba
 - a) si la bomba no aspira a pesar de un llenado suficiente en agua de cebado
 1. Apretar los pernos y accesorios de tubería del lado aspiración.
 2. Comprobar la tensión para asegurarse de que la bomba gira a buena velocidad.
 3. Abrir la bomba y comprobar que nada obstruya el interior,
 4. Ajuste una velocidad de cebado suficiente
 5. Limpie el filtro y vuelva a intentarlo
 6. Reemplazar el obturador mecánico
 - b) Pruebe a realizar un cebado en modo de recirculación. Si la bomba aspira normalmente, comprobar el conducto de aspiración y el prefiltro que podrían estar obstruidos u ocasionar tomas de aire.

E) Bomba ruidosa, comprobar

1. Si ninguna entrada o presencia de aire en la aspiración causa crujidos sordos en la bomba.
2. Si no aparece ninguna cavitación causada por un diámetro insuficiente o una restricción del conducto de aspiración. Así mismo un conducto sobredimensionado en la descarga puede causar esta cavitación. Utilizar tuberías correctas o purgar los conductos, si fuera necesario.
3. Si no aparece ninguna vibración causada por un montaje incorrecto
4. Si no se encuentra ningún cuerpo extraño en el cuerpo de la bomba
5. Si los rodamientos del motor no están gripados por un juego demasiado importante, por el óxido o por un recalentamiento prolongado.



HAYWARD®

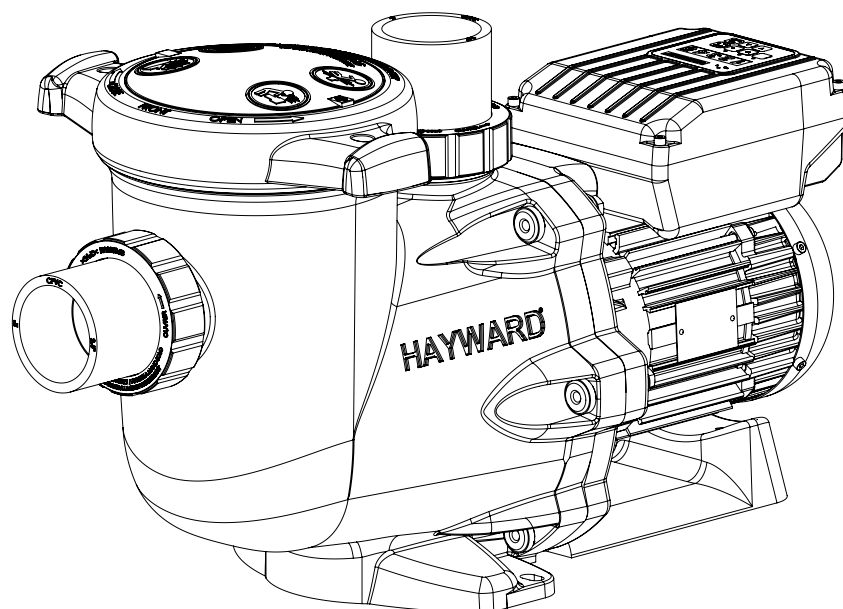

BOMBA CENTRÍFUGA DE VELOCIDADE VARIÁVEL

MANUAL DO UTILIZADOR

CONSERVE ESTE MANUAL PARA REFERÊNCIA FUTURA



AVISO: Perigo eléctrico. O não cumprimento das instruções pode dar origem a ferimentos graves ou morte.

PARA UTILIZAÇÃO EM PISCINAS

- ⚠ AVISO – Antes de abrir a tampa para limpar o filtro, desligue totalmente a bomba da alimentação eléctrica principal.
- ⚠ AVISO – Todas as ligações eléctricas devem ser realizadas por um electricista profissional aprovado e devidamente habilitado e de acordo com as normas em vigor no país de instalação ou, na sua falta, à Norma Internacional IEC 60364-7-702.
- ⚠ AVISO – Certifique-se de que a máquina só é ligada a uma tomada protegida de 230 V[~] que esteja protegida contra curto-circuitos. A bomba deve ser alimentada por um transformador de isolamento ou alimentada através de um dispositivo de corrente residual (RCD) com uma corrente residual nominal de funcionamento não superior a 30 mA.
- ⚠ AVISO – As crianças devem ser vigiadas para assegurar que não brincam com o aparelho. Mantenha os dedos e objectos estranhos afastados das aberturas e peças móveis.
- ⚠ AVISO – O motor tem de ser devidamente ligado à terra. Ligue o fio de terra ao parafuso verde de ligação à terra; para unidades já com cabo de alimentação, utilize tomadas devidamente ligadas à terra.
- ⚠ AVISO – Utilize um grampo de ligação para ligar o motor a outras peças ligadas através do condutor de tamanho adequado, conforme exigido pelos regulamentos eléctricos.
- ⚠ AVISO – Ao efectuar estas ligações eléctricas, consulte o diagrama fornecido sob a tampa da caixa de terminais do motor. Certifique-se de que as ligações eléctricas estão bem apertadas e vedadas antes de ligar a alimentação de energia. Volte a instalar todas as tampas antes de colocar em funcionamento.
- ⚠ AVISO – Certifique-se de que a tensão eléctrica de alimentação do motor corresponde à da rede de distribuição e que os cabos de alimentação eléctrica correspondem à potência e corrente da bomba.
- ⚠ AVISO – Leia e siga todas as instruções neste manual do proprietário e no equipamento. O não cumprimento das instruções poderá causar ferimentos. Este documento deve ser fornecido ao proprietário da piscina e deve ser guardado por este último em local seguro.
- ⚠ AVISO – Este aparelho pode ser utilizado por crianças a partir dos 8 anos inclusive e pessoas com capacidades físicas, sensoriais e mentais reduzidas ou pessoas com falta de experiência e conhecimento desde que instruídas/supervisionadas e que compreendam os riscos envolvidos. As crianças não devem brincar com o aparelho. A limpeza e manutenção do aparelho não deverão ser levadas a cabo por crianças a não ser que tenham mais de 8 anos e sob supervisão. Mantenha o aparelho e o cabo afastados de crianças menores de 8 anos de idade.
- ⚠ AVISO – A bomba é destinado para a operação contínua, à temperatura de água máxima de 35°C.
- ⚠ AVISO – Utilize apenas peças sobresselentes originais Hayward®.
- ⚠ AVISO – Se o cabo de alimentação estiver danificado, tem de ser substituído pelo fabricante, pelo seu agente de assistência ou por pessoas com qualificações semelhantes, no sentido de evitar quaisquer perigos.
- ⚠ AVISO – Para desligar da alimentação eléctrica principal, tem de ser incorporado um interruptor externo com uma separação de contactos em todos os pólos que permita um corte total em condições da categoria de sobretensão III na instalação eléctrica fixa, de acordo com as regras de instalação eléctrica.
- ⚠ AVISO – Não utilize a bomba da piscina se o cabo de alimentação ou o cárter da caixa de ligação do motor estiverem danificados. Fazê-lo pode resultar em choque eléctrico. Se o cabo de alimentação ou o cárter de ligação do motor estiverem danificados, têm de ser imediatamente substituídos por um agente de assistência ou por uma pessoa com qualificações semelhantes, no sentido de evitar quaisquer perigos.
- ⚠ AVISO – Este motor de piscina NÃO está munido de um sistema de anulação de vácuo de segurança (SVRS). O SVRS ajuda a evitar situações de afogamento devido ao aprisionamento do corpo em drenos subaquáticos. Em algumas configurações de piscinas, se o corpo de uma pessoa tapar o dreno, essa pessoa pode ficar aprisionada devido ao efeito de aspiração. Em função da configuração da sua piscina, pode ser necessário um SVRS para suprir os requisitos locais.
- ⚠ AVISO – Esta bomba contém uma bateria que, por questões de segurança, qualquer manipulação deve ser realizada por um serviço técnico autorizado.

UTILIZE APENAS COMPONENTES DE SUBSTITUIÇÃO GENUÍNOS HAYWARD®

GENERALIDADES

Parabéns, acaba de adquirir uma bomba de velocidade variável Hayward®.

As bombas de velocidade variável da Hayward® possuem um motor de imã permanente com comutação electrónica de CA de última geração. Este motor é controlado por um microprocessador associado a um variador de frequência, permitindo as características seguintes:

- Visualização da velocidade de rotação no ecrã de controlo
- 3 velocidades de rotação predefinidas de fábrica (botões V1, V2, V3), velocidades reguláveis pelo utilizador
- Escorvamento sistemático a cada arranque, velocidade e duração do escorvamento reguláveis
- Função Skimmer, escumagem da superfície da água
- Função Timer programável
- Visualização da potência instantânea consumida
- Visualização do consumo de energia total e parcial
- Visualização do tempo de funcionamento da bomba
- Baixo nível sonoro
- Norma de construção TEFC IP55

Instalar a bomba a uma distância adequada da piscina de modo a reduzir o mais possível a ligação entre a aspiração e a bomba, limitando assim as perdas de carga inúteis e excessivas no circuito hidráulico.

Porém, é necessário respeitar obrigatoriamente uma distância de segurança exigida pela norma de instalação em vigor (mínimo de 3.5 metros). Instalar e usar o produto a uma altitude inferior a 2000m.

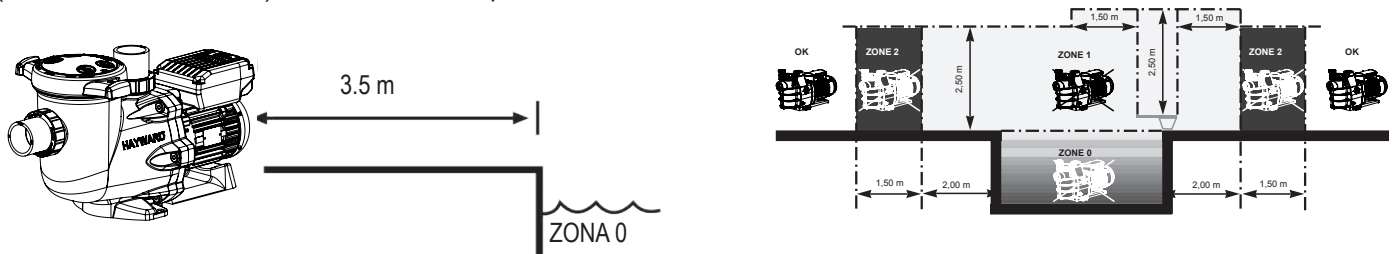

Instalar a bomba num local ventilado e seco; o motor precisa que o ar circule livremente à volta da bomba para permitir a sua ventilação natural. Considerar uma folga mínima de 0,5 m à volta da bomba. Verificar regularmente que objectos, folhas ou quaisquer outros elementos não obstruem a refrigeração do motor.

A bomba deve ser instalada de forma a que o interruptor exterior de desligação que está integrado na caixa fixa esteja visível e facilmente acessível. O interruptor deve estar situado perto da bomba.

A bomba deve ser instalada permanentemente sobre um suporte em betão através de parafusos de cabeça hexagonal de Ø 8 mm adaptados ao betão, aparafusados nos locais onde foram realizados orifícios de implantação. Devem ser previstas anilhas de retenção para impedir qualquer desaperto dos parafusos de montagem de cabeça hexagonal ao longo do tempo. Se a bomba tiver de ser montada sobre um pavimento em madeira, devem ser utilizados parafusos de cabeça hexagonal de Ø 8 mm adaptados à madeira – bem como anilhas de retenção destinadas a impedir qualquer desaperto ao longo do tempo.

Instalar a bomba num local abrigado, de modo a não expor a caixa de controlo a fortes projecções de água.

A pressão acústica das bombas Hayward® é inferior a 70 dBA.

Disposições necessárias:

- Ligar a bomba à terra: nunca colocar a bomba em funcionamento sem que esteja ligada à terra.
- Ligar a bomba com um cabo do tipo H07RN-F 3G1,5mm².
- Prever um dispositivo de protecção diferencial de 30 mA, destinado a proteger as pessoas contra os choques eléctricos provocados por uma eventual ruptura do isolamento eléctrico do equipamento.
- Prever uma protecção contra os curtos-circuitos (a definição do calibre é feita em função do valor indicado na placa do motor).
- Prever um meio de desligação da rede de alimentação com uma distância de abertura dos contactos de todos os pólos que garanta um corte completo nas condições de categoria de sobretensão III.

⚠ ATENÇÃO: aguardar 5 minutos após ter desligado totalmente a bomba da rede eléctrica antes de intervir sobre o motor ou a caixa de ligação: **risco de choque eléctrico, passível de provocar a morte.**

Os motores eléctricos que equipam as nossas bombas estão munidos de uma protecção térmica; esta protecção reage aquando de uma sobrecarga ou de um aquecimento anormal da bobinagem do motor. Esta protecção reactiva-se automaticamente quando a temperatura da bobinagem baixa.

Se a regulamentação o impuser e independentemente do tipo de motor utilizado, é necessário instalar, para além dos dispositivos enumerados abaixo, uma protecção magneto-térmica, que deve ser calibrada de acordo com as indicações da placa do motor.

O quadro na página 169 indica as diferentes características do motor que equipam as nossas bombas.

UTILIZE APENAS COMPONENTES DE SUBSTITUIÇÃO GENUÍNOS HAYWARD®

Ligação eléctrica: certificar-se de que a tensão de alimentação exigida pelo motor corresponde à da rede de distribuição e que a secção e o comprimento do cabo de alimentação são adaptados à potência e à intensidade da bomba.

Todas as ligações eléctricas da bomba, bem como a eventual alteração do cabo de alimentação, devem ser realizadas por um profissional devidamente habilitado, de modo a evitar qualquer perigo.

Para realizar estas ligações eléctricas, respeitar as marcas de referência inscritas por baixo dos terminais de ligação.

Certificar-se do aperto e da estanqueidade das ligações eléctricas antes da colocação sob tensão.

Respeitar a passagem do cabo pelo orifício e da ferrite prevista para o efeito; o buçim garante a estanqueidade à volta do cabo e a ferrite constitui um filtro para as perturbações electromagnéticas.

A pré-cablagem eventual que equipa algumas das nossas bombas deve ser retirada aquando da ligação definitiva da bomba à alimentação eléctrica. De facto, este pré-equipamento apenas é utilizado para os testes de fábrica durante as fases de fabrico.

INSTALAÇÃO

Instalar a bomba da piscina limitando ao máximo as perdas de carga e respeitando as condições de afastamento de pelo menos 3,5 m entre esta e a piscina, conforme indicado na norma de instalação. A conduta de aspiração deve ser instalada com um ligeiro declive ascendente para o eixo da bomba. Certificar-se de que as ligações estão correctamente apertadas e estanques. Todavia, evitar bloquear estas tubagens de forma exagerada. Para os materiais plásticos, garantir a estanqueidade apenas com Teflon. O tubo de aspiração terá um diâmetro superior ou no mínimo igual ao de descarga. Evitar locais não ventilados ou húmidos. O motor exige que o ar de refrigeração possa circular livremente. Instalar a bomba num local abrigado, de modo a não expor a caixa de controlo a fortes projecções de água.

IMPORTANTE: verificar o sentido de rotação antes da ligação definitiva do motor.

INSTRUÇÕES DE ARRANQUE E DE ESCORVAMENTO: Encher de água o corpo do pré-filtro até ao nível do tubo de aspiração. Nunca colocar a bomba em funcionamento sem água, dado que a água é necessária para a refrigeração e lubrificação do obturador mecânico. Abrir todas as válvulas das condutas de aspiração e de descarga, bem como a purga de ar do filtro, caso exista. (Deverá ser eliminado todo o ar presente nas condutas de aspiração.) Accionar o grupo e aguardar um tempo razoável para o escorvamento. Cinco minutos não é um período de tempo exagerado para escorvar (este escorvamento depende da altura de aspiração e do comprimento do tubo de aspiração). Se a bomba não arrancar ou não escorvar, consulte o guia de resolução de avarias.

UTILIZAÇÃO DA UNIDADE DE CONTROLO

1. APRESENTAÇÃO

A bomba de velocidade variável Hayward® é pilotada por uma unidade de controlo que permite visualizar os parâmetros de funcionamento, configurá-los e programar o modo Timer.

1	Avisador LED de colocação sob tensão
2	Ecrã de visualização LED
3	Seleção da velocidade
4	Alternar entre o modo Manual/modo Timer
5	Botões de configuração alto/baixo
6	Botão Arranque/Paragem
7	Botão de visualização dos parâmetros
8	Avisadores LED para velocidade seleccionada

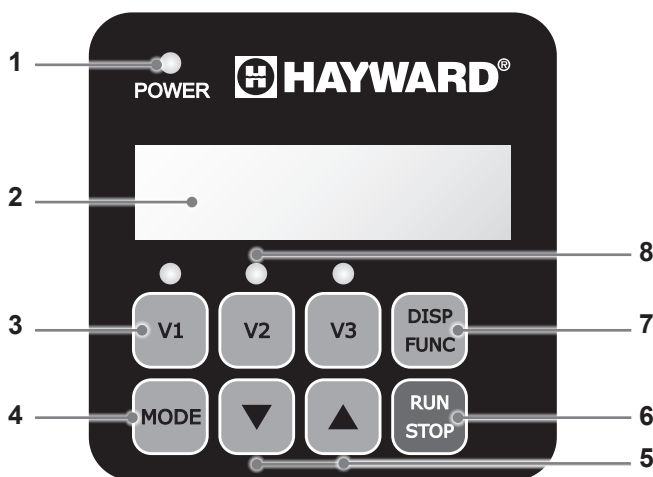

A bomba é fornecida com os **PARÂMETROS PREDEFINIDOS** (configurações de fábrica):

Escorvamento duração (seg.)	Escorvamento velocidade (rpm)	V1 (rpm)	V2 (rpm)	V3 (rpm)	Skimmer duração (min.)	Skimmer ciclo (h)	Skimmer velocidade (rpm)
240	3000	1500	2400	3000	15	1h	2800

rpm: Rotações Por Minuto

UTILIZE APENAS COMPONENTES DE SUBSTITUIÇÃO GENUÍNOS HAYWARD®

2. MODOS DE FUNCIONAMENTO DA BOMBA

2.1 Modo Manual

Em modo Manual o utilizador arranca ou para a bomba manualmente, em função da utilização da piscina.

- O arranque da bomba lança uma fase de escorvamento (a). Esta fase é configurável (velocidade e duração, § 4.2). O escorvamento pode ser interrompido durante o arranque (§ 3.2) ou desativado pelas configurações.
- A velocidade da bomba estabiliza depois num valor constante (b) (por defeito estabilização na velocidade V2). Esta velocidade pode ser selecionada e configurada pelo utilizador (§ 3.3).
- Depois de uma paragem/rearranque, a bomba estabilizará na última velocidade memorizada.

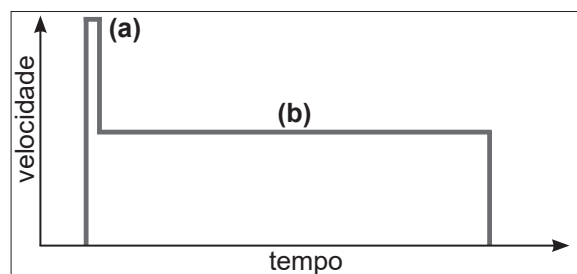

2.2 Skimmer

A função Skimmer permite escumar a superfície da água, nomeadamente para evitar a acumulação de sujidade na superfície da piscina.

- Esta função é automática: a bomba funciona a uma velocidade mais elevada (c) durante um período e segundo um ciclo reguláveis.
- Após este aumento de velocidade, a bomba retoma a sua velocidade normal, seja em modo Manual ou em modo Timer.
- A função Skimmer pode ser desativada (ver configurações § 4.3).

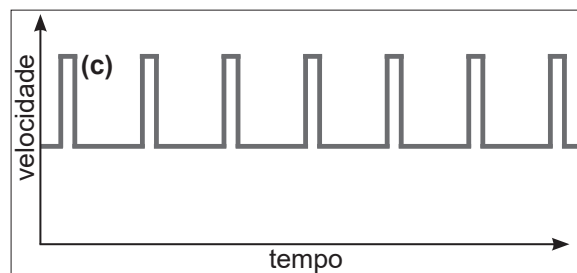

2.3 Modo Timer

Em modo Timer o funcionamento da bomba é automatizado 24/24 horas. As diferentes sequências de velocidade (d) são programadas pelo utilizador. Serão escolhidas em função da instalação (modo de aquecimento, economizador de energia, etc.) e dos horários de utilização da piscina.

- Se a função Skimmer estiver ativada, sobrepõe-se a estas sequências.
- A bomba pode ser parada (colocada em pausa) no modo Timer. No rearranque a velocidade será a do Timer em curso.
- Para programar o modo Timer consulte o § 4.5.

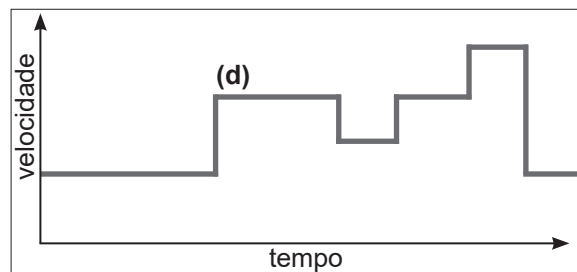

2.4 Alternar entre o modo Manual/modo Timer

A mudança de modo efetua-se premindo o botão **MODE** conforme se ilustra a seguir:

Modo manual

Visualização velocidade sem prefixo

O LED aceso indica a velocidade selecionada (V2 por defeito)

Modo Timer

Visualização velocidade com prefixo "t"

Os LED estão apagados

UTILIZE APENAS COMPONENTES DE SUBSTITUIÇÃO GENUÍNOS HAYWARD®

2.5 Ligação das entradas digitais externas

⚠ ATENÇÃO: Antes de qualquer trabalho eléctrico na bomba, desligue o cabo de alimentação e espere 5 min.

A bomba de filtração tem um cabo equipado com 5 fios de 3 m de comprimento que permite a ligação de 4 entradas digitais ou contactos secos livres de potencial (Aberto/Fechado).

Exemplos de utilização das entradas digitais

- Atribuir a velocidade e o débito necessários para o bom funcionamento de órgãos periféricos como uma bomba de calor, um estore ou um robô de aspiração, etc...
- Instale um lembrete de acção a partir da interface do utilizador. Estas entradas digitais permitem controlar à uma distância de 3 m a função Run/Stop, bem como as 3 velocidades (V1-V2-V3).

Afetação dos fios		
DI1	Castanho	Velocidade V1
DI2	Verde	Velocidade V2
DI3	Branco	Velocidade V3
DI4	Vermelho	Run/Stop
C	Preto	Comum

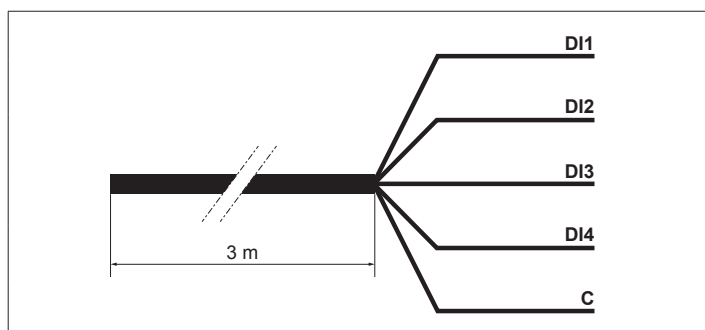

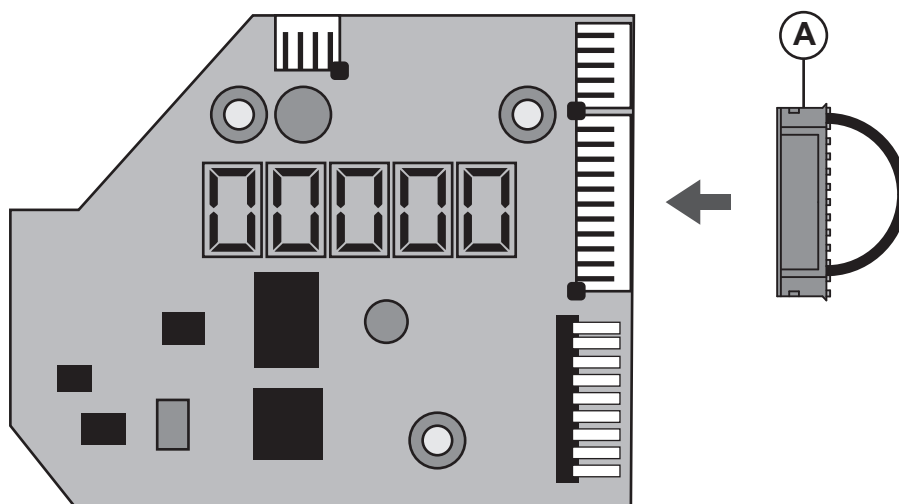

Nota :

- Em caso de utilização parcial das entradas digitais, isolar electricamente os fios não utilizados.
- Em caso de não utilização das entradas digitais, inserir o conector (A) em vez do cabo de 5 fios (veja a figura abaixo).



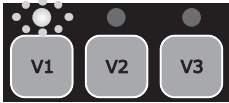

UTILIZE APENAS COMPONENTES DE SUBSTITUIÇÃO GENUÍNOS HAYWARD®

Funcionamento com as entradas digitais

<p>As entradas digitais são utilizáveis em modo Manual ou em modo Timer. Estas têm o mais alto nível de prioridade: são o MESTRE de todas as funções em uso. Só os botões Run/Stop e DISP/FUNC permanecem activos.</p>	 
<p>Quando uma entrada digital é utilizada, o LED associado à velocidade em causa pisca rapidamente (DI1 = V1, DI2 = V2 ou DI3 = V3).</p>	

<p>Para obter uma acção pelas entradas digitais, a entrada DI4 deve ficar fechada.</p>	<p>➔ DI4 Run/StopFechado</p>			
<p>Se várias entradas digitais forem comutadas simultaneamente, só uma delas será executada na ordem de prioridade definida pela tabela aqui ao lado.</p>		DI1 = V1	DI2 = V2	DI3 = V3
	DI1 = V1	V1	V2	V3
	DI2 = V2	V2	V2	V3
DI3 = V3	V3	V2	V3	

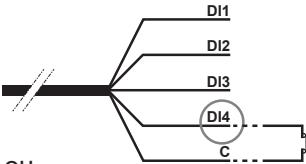
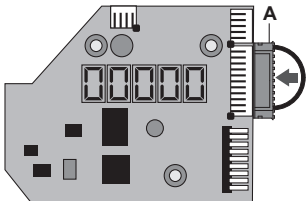
Nota : Quando a acção associada com a entrada digital estiver terminada (contacto aberto), a bomba de filtração retomará a acção do modo de funcionamento corrente.

<p>Se a entrada digital DI4 estiver aberta, a bomba de filtração não funciona e dSTOP aparece no ecrã da bomba.</p>	
<ul style="list-style-type: none"> • Fechar a entrada DI4. • Premir eventualmente o interruptor RUN/STOP para fazer funcionar a bomba de filtração. 	
	
	

3. UTILIZAÇÃO









3.1 Colocação sob tensão

O avisador "Power" acende-se; o ecrã efetua um teste LCD e, depois, exhibe a versão do software

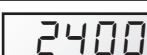







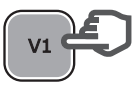

3.2 Fase de escorvamento

Depois da colocação da bomba sob tensão, a fase de escorvamento inicia-se automaticamente (tal como depois de um re arranque da bomba).



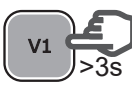





<p>Lançamento automático da fase de escorvamento:</p> <ul style="list-style-type: none"> A velocidade aumenta até 3000 rpm e é mantida durante 240 seg. (valores predefinidos) 		→		
<p>Fim da fase de escorvamento:</p> <ul style="list-style-type: none"> Por defeito, a velocidade estabiliza-se em V2 ou na última velocidade memorizada O LED correspondente acende-se (modo Manual) 		→		
<p>Para exibir o tempo de escorvamento restante:</p> <ul style="list-style-type: none"> Premir DISP/FUNC O tempo restante é exibido em seg. 		→		
<p>Para sair antes do final da fase de escorvamento:</p> <ul style="list-style-type: none"> Premir RUN/STOP Por defeito, a velocidade estabiliza-se em V2, ou na última velocidade memorizada 		→		

3.3 Em modo Manual: seleção, configuração e memorização de uma velocidade

<p>Para seleccionar uma velocidade:</p> <ul style="list-style-type: none"> Premir um dos botões de velocidade O valor por defeito é exibido (em rpm) O LED correspondente acende-se 		→		
<p>Para definir um novo valor de velocidade:</p> <ul style="list-style-type: none"> Premir os botões de configuração alto/baixo O LED pisca: configuração em curso Definir o valor desejado (de 600 a 3000 rpm) 		→		
<p>Para guardar o novo valor de velocidade:</p> <ul style="list-style-type: none"> Premir o botão de velocidade durante 3 seg. O LED torna-se fixo quando a velocidade é memorizada 		→		

Nota: O débito de água gerado pela velocidade da bomba deve ser adaptado à capacidade da instalação (filtro, canalizações, etc.). Em caso de dúvida, recorra a um profissional.

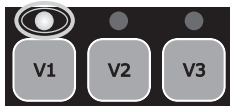
3.4 Paragem/re arranque da bomba

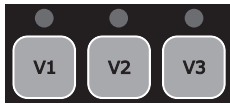











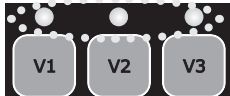

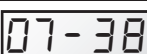
<p>Para parar a bomba:</p> <ul style="list-style-type: none"> Premir RUN/STOP A bomba para, o LED de velocidade fica aceso Em modo Manual o ecrã exhibe "StoP" em posição fixa Em modo Timer o ecrã exhibe "StoP" a piscar 		→	 	
<p>Para o re arranque da bomba:</p> <ul style="list-style-type: none"> Premir RUN/STOP A bomba arranca na fase de escorvamento (§ 3.2) A velocidade estabiliza: 		→		
<ul style="list-style-type: none"> em modo Manual no último valor memorizado, em modo Timer na velocidade correspondente ao Timer em curso 		→		

UTILIZE APENAS COMPONENTES DE SUBSTITUIÇÃO GENUÍNOS HAYWARD®



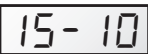







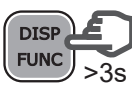

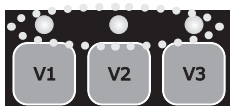

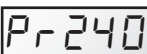





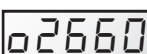

4. CONFIGURAÇÕES

Nota: Para aceder às configurações, a bomba deve estar sob tensão e **em modo Manual** (§ 2.4), parada ou em funcionamento fora da fase de escorvamento.
Se não for premido qualquer botão durante 2 min., a visualização passa a normal (velocidade ou StoP) e as definições não são guardadas.

4.1 Acerto do relógio

<ul style="list-style-type: none"> • Premir durante 3 seg. DISP/FUNC Os 3 LED piscam • O ecrã exibe "ConF" depois "hr" 		 		
<ul style="list-style-type: none"> • Premir DISP/FUNC, o ecrã exibe a hora do relógio interno (hh-min) 		 		
<ul style="list-style-type: none"> • Premir os botões de configuração baixo/alto para definir as horas/minutos 		 		 
<ul style="list-style-type: none"> • Premir RUN/STOP para sair e guardar A visualização indica a velocidade em curso ou StoP 		 		
<p>Nota: O ajuste do relógio interno é importante se a bomba funcionar em modo Timer. Fica memorizado quanto a bomba é colocada sem tensão.</p>				

4.2 Configuração do escorvamento

<ul style="list-style-type: none"> • Premir durante 3 seg. DISP/FUNC Os 3 LED piscam e o ecrã exibe "ConF" 		 	
<ul style="list-style-type: none"> • Premir DISP/FUNC n vezes até obter no ecrã "Pr 240": duração do escorvamento por defeito (seg.) 		 	
<ul style="list-style-type: none"> • Premir os botões de configuração alto/baixo para visualizar a duração desejada (de 0 seg. a 300 seg.) 	 	 	
<ul style="list-style-type: none"> • Premir DISP/FUNC: o ecrã exibe "03000" velocidade de escorvamento por defeito (rpm) 		 	
<ul style="list-style-type: none"> • Premir os botões de configuração alto/baixo para visualizar o valor desejado (máximo 3000 rpm) 	 	 	
<ul style="list-style-type: none"> • Premir RUN/STOP para sair e guardar A visualização indica a velocidade em curso ou StoP 		 	
<p>Nota: Se a duração de escorvamento for zero a visualização passa a "ProFF": o escorvamento está desativado</p>		 	 

4.3 Configuração da função Skimmer

Ver o § 2.2 para a apresentação desta função

<ul style="list-style-type: none"> Premir durante 3 seg. DISP/FUNC Os 3 LED piscam e o ecrã exibe "ConF" 		→	ConF	
<ul style="list-style-type: none"> Premir DISP/FUNC n vezes até obter no ecrã "SFO.15": duração de ativação do Skimmer por defeito (em minutos) 		→	SFO.15	
<ul style="list-style-type: none"> Premir os botões de configuração alto/baixo para visualizar a duração desejada (de 0 a 30 min.) 		→	SFO20	
<ul style="list-style-type: none"> Premir DISP/FUNC: o ecrã exibe "St 1h": duração do ciclo de Skimmer por defeito 		→	St 1h	
<ul style="list-style-type: none"> Premir os botões de configuração para configurar o ciclo Skimmer em 1 h, 2 h ou 3 h 		→	St2h	
<ul style="list-style-type: none"> Premir DISP/FUNC: o ecrã exibe "S2800": velocidade do Skimmer por defeito (rpm) 		→	S2800	
<ul style="list-style-type: none"> Premir os botões de configuração alto/baixo para visualizar a velocidade desejada (de 600 a 3000 rpm) 		→	S2680	
<ul style="list-style-type: none"> Premir RUN/STOP para sair e guardar A visualização indica a velocidade em curso ou StoP 		→	1640 / StoP	
Nota: Para desativar o Skimmer, colocar a sua duração em zero - A visualização passa a "SFoFF"		→	SFoFF	

4.4 Reinicialização dos parâmetros

Para restaurar os parâmetros por defeito e apagar as definições do modo Timer, proceda do seguinte modo:

<ul style="list-style-type: none"> Premir durante 3 seg. DISP/FUNC Os 3 LED piscam e o ecrã exibe "ConF" 		→	ConF	
<ul style="list-style-type: none"> Premir DISP/FUNC n vezes até obter a mensagem "Init" no ecrã 		→	Init	
<ul style="list-style-type: none"> Premir o botão de configuração "alto" durante 3 seg. A visualização passa a "donE" quando é efetuada a reinicialização. 		→	donE → StoP	

Recordar: parâmetros predefinidos e gamas de regulação

	Escorvamento		Botões de velocidade			Função Skimmer			Função Timer			
	Pr	o...	V1	V2	V3	SF	St	S...	t0	rpm	t1 - t5	rpm
Unidade	seg.	rpm	rpm	rpm	rpm	min	h	rpm	hh-min	rpm	hh-min	rpm
Predefinido	240	3000	1500	2400	3000	15	1	2800	06-00	2400	oFF	0
Mini	0 (oFF)	600	600	600	600	0 (oFF)	1 ...	600	00-00	—	00-00	0/ 600
Maxi	300	3000	3000	3000	3000	30	... 3	3000	24-00	—	24-00	3000

UTILIZE APENAS COMPONENTES DE SUBSTITUIÇÃO GENUÍNOS HAYWARD®

4.5 Programação do modo Timer

A unidade de controlo permite programar diversas sequências (ver § 2.3) ou Timers t0 a t5, que não têm que seguir necessariamente a ordem cronológica.

Os Timer não utilizados serão desativados.

O Timer "t0" pode ser fixado em 00:00, 06:00 (por defeito); 12:00 ou 18:00. Não pode ser desativado.

A velocidade do segmento t0 não é ajustável, está fixada em 2400 rpm

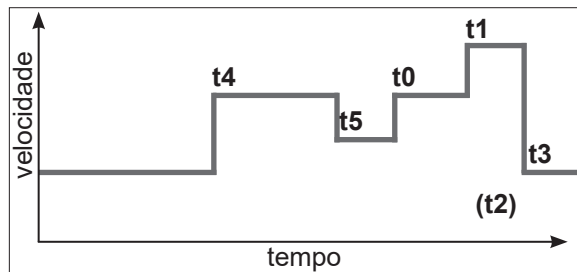

















- Trace o perfil de velocidade que pretende programar. O gráfico seguinte é apresentado a título de exemplo.
- Verifique se o relógio interno está acertado corretamente.

<ul style="list-style-type: none"> • Premir durante 3 seg. DISP/FUNC Os 3 LED piscam e o ecrã exibe "ConF" 		→	ConF			
<ul style="list-style-type: none"> • Premir DISP/FUNC 2 vezes até obter a visualização "t0" 		→	t0			
<ul style="list-style-type: none"> • Premir DISP/FUNC, o ecrã exibe "06-00": valor de t0 por defeito 		→	06-00			
<ul style="list-style-type: none"> • Premir os botões de configuração para fixar o t0 desejado (00-00, 06-00, 12-00 ou 18-00) 		→	18-00			
<ul style="list-style-type: none"> • Premir DISP/FUNC: o ecrã exibe "t1oFF" 		→	t1oFF			
<ul style="list-style-type: none"> • Para ativar este Timer (exemplo) premir o botão "alto". O ecrã exibe "t1 on" 		→	t1 on			
<ul style="list-style-type: none"> • Premir DISP/FUNC: o ecrã exibe "00-00" 		→	00-00			
<ul style="list-style-type: none"> • Premir os botões de configuração baixo/alto para definir o horário desejado (hh-mm) 		→	20-00		→	20-15
<ul style="list-style-type: none"> • Premir DISP/FUNC: o ecrã exibe "0" 		→	0			
<ul style="list-style-type: none"> • Premir os botões de configuração para visualizar a velocidade desejada (de 600 a 3000 rpm ou zero) 		→	2740			
<ul style="list-style-type: none"> • Para passar ao Timer seguinte prima DISP/FUNC: o ecrã exibe "t2oFF". No exemplo, este Timer fica desativado 		→	t2oFF			
<ul style="list-style-type: none"> • Prima DISP/FUNC para passar ao Timer seguinte e repita as etapas de configuração (ativação, horário Timer e velocidade) 		→	t3oFF	etc ...		
<ul style="list-style-type: none"> • Premir RUN/STOP para sair e guardar A visualização indica a velocidade em curso ou StoP 		→	1640 / StoP			

UTILIZE APENAS COMPONENTES DE SUBSTITUIÇÃO GENUÍNOS HAYWARD®

5. VISUALIZAÇÃO DOS PARÂMETROS

Nota: A bomba deve estar sob tensão, em funcionamento fora da fase de escorvamento ou parada.
 Para visualizar os parâmetros, prima a tecla DISP/FUNC.
 Se não for premeida qualquer tecla durante 15 seg., o ecrã passa à visualização normal (velocidade em curso ou Stop).

<ul style="list-style-type: none"> • Premir DISP/FUNC: o ecrã exibe "hr" Premir novamente: visualização da hora interna 	 → hr	 → 11-45
<ul style="list-style-type: none"> • Premir DISP/FUNC: o ecrã exibe "t0" Premir novamente: visualização do horário do t0 (a velocidade do t0 é fixada em 2400 rpm) 	 → t0	 → 12-00
<ul style="list-style-type: none"> • Premir DISP/FUNC: o ecrã exibe "t1" Premir novamente: visualização do horário deste Timer (hh-mm) 	 → t1	 → 09-20
<ul style="list-style-type: none"> • Premir DISP/FUNC: visualização da velocidade deste Timer (em rpm) 	 → 1240	
<ul style="list-style-type: none"> • Premir DISP/FUNC etc.: visualização dos Timers seguintes, horário e velocidade, até ao Timer "t5" Nota: Os Timers desativados não são exibidos 	 → t2	etc ...
<ul style="list-style-type: none"> • Premir DISP/FUNC: visualização "P - - - -" Potência consumida (em W, valor de +/- 10%) Nota: P = 0 W quando a bomba está parada 	 → P 634 / P 0	
<ul style="list-style-type: none"> • Premir DISP/FUNC: visualização "h - - - -" Contador horário da bomba Nota: Uma volta do contador representa 9999 h 	 → h2857	
<ul style="list-style-type: none"> • Premir DISP/FUNC: visualização "- - - - -" Consumo total de energia (em kWh) Nota: Uma volta do contador representa 99999 kWh 	 → 06542	
<ul style="list-style-type: none"> • Premir DISP/FUNC: visualização "- - - - -" Consumo parcial de energia (em kWh), desde a última reposição a zero 	 → 00086	
<ul style="list-style-type: none"> • Para repor o contador parcial de energia a zero: Premir um dos botões alto/baixo durante 3 seg.. A mensagem "CLEAR" indica que o contador está reposto a zero 	  → CLEAR	
<ul style="list-style-type: none"> • Premir DISP/FUNC: Visualização "SF On" ou "SFOFF" para Skimmer ativado/desativado 	 → SF On / SFOFF	
<ul style="list-style-type: none"> • Premir DISP/FUNC: Visualização "t - -" Temperatura do módulo de potência (em °C) 	 → t 74	
<ul style="list-style-type: none"> • Premir DISP/FUNC para regressar à visualização normal (velocidade em curso ou Stop) 	 → 1640 / Stop t2400 / Stop	

MANUTENÇÃO

1. Desligue totalmente a bomba da alimentação da rede antes de abrir a tampa e de limpar o pré-filtro. Limpar regularmente o cesto do pré-filtro; não bater no cesto para o limpar. Verificar a junta da tampa do pré-filtro e substituí-la se necessário.
2. O eixo do motor está montado sobre rolamentos auto-lubrificantes que não requerem qualquer lubrificação posterior.
3. Manter o motor limpo e seco e certificar-se de que os orifícios de ventilação estão livres de qualquer obstrução.
4. Ocasionalmente, o selo mecânico pode apresentar uma fuga e, portanto, deverá ser substituído.
5. À excepção da limpeza da piscina, todas as operações de reparação, conservação ou manutenção devem obrigatoriamente ser efectuadas por um agente aprovado pela Hayward® ou por uma pessoa devidamente habilitada.

As peças de desgaste da bomba mencionadas abaixo devem ser mantidas de acordo com sua vida útil estimada:

Vida estimada das peças de desgaste:

Selo mecânico	1 ano
Kit de rolamento do motor	1 ano
Kit de juntas (pré-filtro, corpo, conexões, dreno)	2 anos
Capacitor	2 anos

INVERNAÇÃO

1. Esvaziar a bomba ao retirar todos os tampões de escoamento e guardá-los no cesto do pré-filtro.
2. Desligar a bomba, retirar as ligações das tubagens e guardar o grupo completo num local seco e arejado ou, pelo menos, tomar a seguinte precaução: desligar a bomba, retirar os 4 parafusos de fixação do corpo da bomba no suporte do motor e guardar o conjunto num local seco e arejado. Em seguida, proteger o corpo da bomba e do pré-filtro ao cobri-los.

OBSERVAÇÃO: antes de voltar a colocar a bomba em funcionamento, limpar todas as partes internas removendo as poeiras, o tártaro, etc.

POSSÍVEIS AVARIAS E SOLUÇÕES

A) O motor não liga

1. Verificar as ligações eléctricas, os interruptores ou relés, bem como os corta-circuitos ou fusíveis.
2. Certificar-se manualmente da livre rotação do motor.
3. Certificar-se de que as velocidades de rotação V1, V2 e V3 não estão programadas para 0 rpm; caso contrário, proceder a uma reinicialização dos parâmetros de fábrica (ver § 4.4).
4. Se o ecrã exibir um dos códigos de erro que se seguem, contacte o seu instalador:

Err01	Sobtensão da linha contínua	Err10	Problema de alimentação eléctrica interna
Err02	Sobretensão da linha contínua	Err20	Falha de arranque
Err04	Sobreaquecimento do módulo de potência	Err64	Problema de curto-circuito interno
Err05	Sobreaquecimento do motor	Err97	Problema múltiplo
Err07	Sobrecorrente	Err98	Problema de comunicação
		dStoP	Ver página 49

B) O motor pára, verificar

1. Os cabos, ligações, relés, etc.
2. A queda de tensão no motor (frequentemente causada por cabos demasiado fracos).
3. Que não aparece qualquer gripagem ou sobrecarga (por leitura da amperagem absorvida).

OBSERVAÇÃO: O motor da sua bomba está munido de uma protecção térmica que, em caso de sobrecarga, cortará automaticamente o circuito e evitará que o motor se deteriore. Este accionamento é causado por condições anormais de utilização que é necessário verificar e corrigir. O motor voltará a funcionar sem qualquer intervenção assim que as condições normais de funcionamento forem restabelecidas.

C) “OLOAD” aparece no visor (problema de sobrecarga ou sobreaquecimento)

1. Verificar que o veio do motor roda livremente.
2. Verificar que nenhum resíduo obstrui a livre rotação da turbina.
3. Verificar que o motor é correctamente ventilado.
4. Após ter resolvido o problema, prima o botão Ligar/Desligar.

D) A bomba não escorva

1. Certificar-se de que o corpo do pré-filtro está bem cheio de água, que a junta da tampa está limpa e correctamente posicionada e que nenhuma entrada de ar é possível. Se necessário, voltar a apertar os parafusos de bloqueio da tampa.
2. Certificar-se de que todas as válvulas de aspiração e de descarga estão abertas e não obstruídas, e que todas as bocas de aspiração da piscina estão completamente submersas.
3. Verificar que a bomba aspira ao libertar a aspiração o mais perto possível da bomba:
 - a) se a bomba não aspirar apesar de um enchimento suficiente em água de escorvamento:
 1. Voltar a apertar os parafusos e acessórios de tubagem do lado da aspiração.
 2. Verificar a tensão para garantir que a bomba roda à velocidade correcta.
 3. Abrir a bomba e verificar que nada a obstrui no interior.
 4. Definir uma velocidade de escorvamento suficiente
 5. Efetuar uma limpeza do filtro e tentar novamente
 6. Substituir o obturador mecânico.
 - b) Ensaiair um escorvamento em modo de recirculação. Se a bomba aspirar normalmente, verificar a conduta de aspiração e o pré-filtro, que podem estar obstruídos ou causar entradas de ar.

E) Bomba ruidosa, verificar

1. Se nenhuma entrada ou presença de ar na aspiração provoca ruídos na bomba.
2. Se não se verifica qualquer cavitação causada por um diâmetro insuficiente ou uma restrição da conduta de aspiração. Iguamente, uma conduta sobredimensionada na descarga pode causar esta cavitação. Utilizar tubagens correctas ou purgar as condutas, se necessário.
3. Se não aparece qualquer vibração causada por uma montagem incorrecta.
4. Se nenhum corpo estranho se encontra no corpo da bomba.
5. Se os rolamentos do motor não estão gripados devido a uma folga demasiado grande, presença de ferrugem ou um sobreaquecimento prolongado.



HAYWARD®

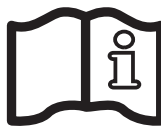
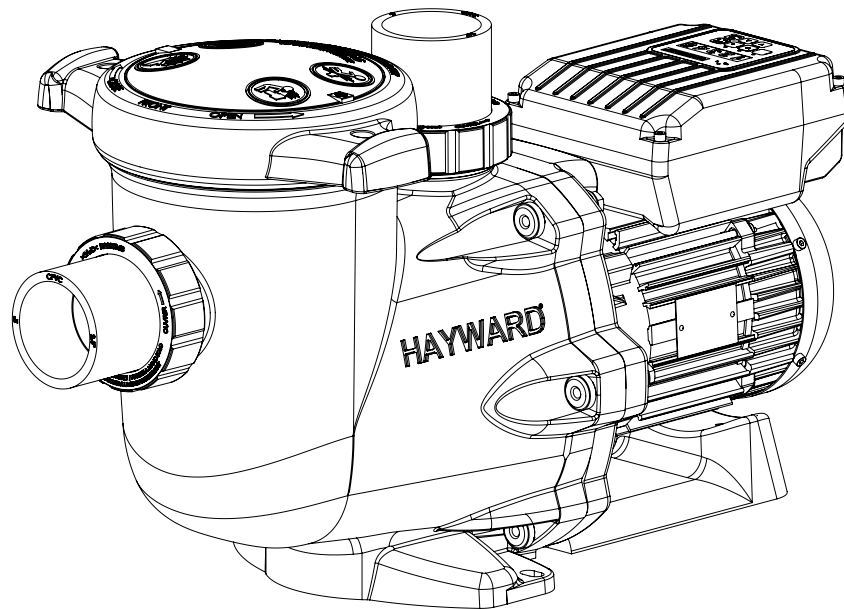

ZENTRIFUGALPUMPE MIT VARIABLER GESCHWINDIGKEIT

ANWENDER - HANDBUCH

BEWAHREN SIE DIESES HANDBUCH FÜR EINE SPÄTERE EINSICHTNAHME AUF



**WARNUNG: Stromschlaggefahr. Die Nichtbeachtung der nachstehenden Anweisungen kann zu schweren Verletzungen oder sogar zum Tod führen.
FÜR DEN EINSATZ IN SCHWIMMBECKEN**

⚠ **WARNUNG** – Vor Öffnen des Deckels Pumpe komplett von der Hauptstromversorgung trennen.

⚠ **WARNUNG** – Die elektrischen Anschlüsse sind von einem zugelassenen qualifizierten Elektriker nach den geltenden Normen im Land der Installation vorzunehmen oder andernfalls dem internationalen Standard IEC 60364-7-702.

⚠ **WARNUNG** – Stellen Sie sicher, dass das Gerät an eine geerdete 230 V~-Steckdose angeschlossen ist, die vor Kurzschlüssen gesichert ist. Die Pumpe muss von einem Trenntransformator oder einer Fehlerstromschutzeinrichtung mit einer begrenzten Betriebsstromstärke bis maximal 30 mA versorgt werden.

⚠ **WARNUNG** – Achten Sie darauf, dass Kinder nicht mit dem Gerät spielen. Die Finger und Fremdkörper dürfen nicht in die Öffnungen und beweglichen Teile geraten.

⚠ **WARNUNG** – Der Motor ist ordnungsgemäß zu erden. Den Erdungsdraht an die grüne Erdungsschraube anschließen und für Geräte mit Kabelanschluss eine ordnungsgemäß geerdete Steckdose verwenden.

⚠ **WARNUNG** – Ein Motoranschlussstück zum Anschluss des Motors an andere Anschlussteile unter Einsatz der entsprechenden Kabelgröße entsprechend den elektrischen Vorschriften verwenden.

⚠ **WARNUNG** – Bei der Herstellung der elektrischen Anschlüsse das Diagramm unter dem Deckel des Motoranschlusskastens beachten. Sich vor dem Einschalten des Stroms vergewissern, dass die elektrischen Anschlüsse fest und versiegelt sind. Vor dem Betrieb alle Abdeckungen wieder aufsetzen.

⚠ **WARNUNG** – Sich vergewissern, dass die Voltzahl der vom Motor benötigten Stromversorgung der Versorgung des Vertriebsnetzwerks entspricht und dass die Stromversorgungskabel der Leistung und dem Strom der Pumpe entsprechen.

⚠ **WARNUNG** – Lesen und befolgen Sie alle Anweisungen dieses Handbuchs und auf dem Gerät. Ein Nichtbeachten kann zu ernsthaften Verletzungen führen.

Dieses Dokument ist dem Eigentümer des Schwimmbeckens zu übergeben und muß von diesem an einem sicheren Ort aufbewahrt werden.

⚠ **WARNUNG** – Dieses Gerät ist für die Nutzung von Kindern ab 8 Jahren und älter sowie von Personen mit eingeschränkten physischen, sensorischen und geistigen Fähigkeiten geeignet, wenn ihnen die Handhabung erklärt wurde/ sie dabei beaufsichtigt werden und ihnen die damit verbundenen Gefahren bewusst sind. Kinder sollten nicht mit dem Gerät spielen. Die Reinigung und Instandhaltung des Geräts sollte nicht von Kindern durchgeführt werden, es sei denn sie sind älter als 8 Jahre und werden dabei beaufsichtigt. Bewahren Sie das Gerät und das Kabel außer Reichweite von Kindern unter 8 Jahren auf.

⚠ **WARNUNG** – Die Pumpe ist für den Dauerbetrieb bei maximaler Wassertemperatur 35°C bestimmt.

⚠ **WARNUNG** – Verwenden Sie nur Original-Ersatzteile von Hayward®.

⚠ **WARNUNG** – Ist das Netzkabel beschädigt, muss es durch den Hersteller, einen zugelassenen Servicepartner oder eine Person mit ähnlichen Qualifikationen ausgetauscht werden, um Gefahren zu vermeiden.

⚠ **WARNUNG** – Zum Trennen der Pumpe von der Hauptstromversorgung muss ein externer Umschalter mit einer Kontakttrennung in allen Polen, die das komplette Abtrennen bei Überspannung der Kategorie III ermöglicht, vorschriftsmäßig in die feste Verkabelung integriert werden.

⚠ **WARNUNG** – Die Swimmingpool-Pumpe nicht in Betrieb nehmen, falls das Versorgungskabel oder das Gehäuse des Motorschaltkastens beschädigt ist. Dies kann zu Elektroschocks führen. Beschädigte Versorgungskabel oder Gehäuse des Motorschaltkastens müssen so schnell wie möglich von einem zugelassenen Fachmann oder einer vergleichbaren qualifizierten Person ersetzt werden, um Gefahren auszuschließen.

⚠ **WARNUNG** – Dieser Poolmotor ist NICHT mit einem Safety Vacuum Release System (SVRS) ausgestattet. Das SVRS hilft bei der Vermeidung der Gefahr des Ertrinkens durch Auffangen des Körpers an Unterwasser-Abläufen. Bei manchen Poolkonstruktionen können Ertrinkende durch Ansaugen aufgefangen werden, wenn sie den Ablauf zudecken. Je nach Poolkonstruktion kann ein SVRS erforderlich sein, um den Standortanforderungen zu genügen.

⚠ **WARNUNG** – Diese Pumpe enthält eine Batterie, die aus Sicherheitsgründen von einem autorisierten technischen Dienst manipuliert werden muss.

VERWENDEN SIE NUR ORIGINAL-ERSATZTEILE VON HAYWARD®

ALLGEMEINES

Herzlichen Glückwunsch, Sie haben ein Hayward® Pumpe mit variabler Geschwindigkeit erworben.

Die Hayward® Pumpen mit variabler Geschwindigkeit besitzen einen Motor mit Dauermagnet und elektronischer AC-Schaltung der jüngsten Generation. Dieser Motor wird von einem Mikroprozessor gesteuert, der an einen Frequenzregler angeschlossen ist. Er besitzt folgende Merkmale:

- Anzeige der Rotationsgeschwindigkeit auf dem Kontrolldisplay
- drei werkseitig voreingestellte Rotationsgeschwindigkeiten (Tasten V1, V2, V3), Geschwindigkeiten durch den Benutzer einstellbar
- systematische Ansaugung bei jedem Start, Ansauggeschwindigkeit und -dauer einstellbar
- Skimmer-Funktion, Abschöpfen der Wasseroberfläche
- einstellbare Timer-Funktion
- Anzeige des momentanen Leistungsverbrauchs
- Anzeige des Gesamt- und Teilenergieverbrauchs
- Anzeige der Betriebszeit der Pumpe
- Geräuscharmer Betrieb
- Konstruktionsnorm TEFC IP55

Pumpe in richtiger Entfernung zum Becken aufstellen, um die Verbindung zwischen Ansaugöffnung und Pumpe so kurz wie möglich zu halten und um unnötigen Druckverlust im Hydraulik-Kreislauf zu vermeiden.

Der Sicherheitsabstand gemäß der geltenden Installationsnorm muss unbedingt beachtet werden (mindestens 3.5 Meter). Installieren und verwenden Sie das Produkt auf einer Höhe von weniger als 2000m

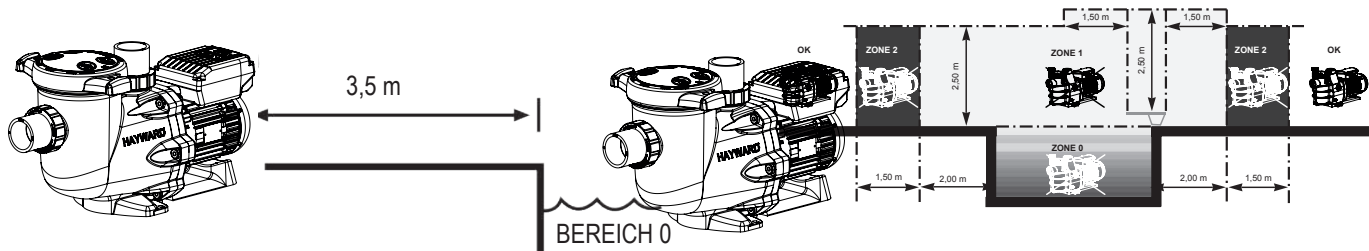

Pumpe an einem belüfteten, trockenen Ort aufstellen. Für einen ordnungsgemäßen Betrieb des Motors muss die Luft frei um die Pumpe zirkulieren können, um ihn auf natürliche Weise zu belüften. Einen Mindestabstand von 0,5 m rund um die Pumpe vorsehen. Regelmäßig prüfen, ob Gegenstände, Blätter oder andere störende Objekte die Motorkühlung verstopfen. Die Pumpe muss so aufgestellt werden, dass der Außenschalter zur Abschaltung, der in das Fixgehäuse integriert ist, sichtbar und leicht zugänglich ist. Der Schalter muss sich in der Nähe der Pumpe befinden.

Die Pumpe muss konstant mit \varnothing 8 mm Beton-Schwellenschrauben auf einen Betonsockel befestigt werden, die an die Stellen eingeschraubt werden, an denen zuvor Montagelöcher gebohrt worden sind. Es müssen Sicherungsscheiben eingesetzt werden, um jegliches Lockern der Schwellenschrauben mit der Zeit zu vermeiden. Falls die Pumpe auf einen Holzsockel montiert werden soll, müssen \varnothing 8 mm Sechskant-Holzschrauben sowie Sicherungsscheiben verwendet werden, um jegliches Lockern mit der Zeit zu vermeiden.

Pumpe geschützt aufstellen, um Wasserspritzer auf dem Steuerungskasten zu vermeiden.

Der Schalldruck der Hayward® Pumpen liegt unter 70 dBA.

Notwendige Vorkehrungen:

- Pumpe erden: Pumpe niemals in Betrieb nehmen, solange diese nicht geerdet ist.
- Pumpe mit einem Kabel vom Typ H07RN-F 3G1,5mm² anschließen.
- 30mA Summenstromwandler vorsehen, um Menschen vor elektrischen Schocks zu schützen, die durch einen möglichen Riss der elektrischen Isolierung des Geräts entstehen können.
- Schutz gegen Kurzschlüsse vorsehen (die Bestimmung des Kalibers richtet sich nach dem auf dem Motorschild angegebenen Wert).
- Abschaltmöglichkeit vom Stromversorgungsnetz vorsehen, die eine Kontakttrennung auf allen Polen besitzen, um ein komplettes Abschalten bei Überspannung der Kategorie III zu gewährleisten.

⚠ ACHTUNG: Nach dem kompletten Abtrennen der Pumpe vom Stromnetz 5 Minuten warten, bevor Sie Arbeiten am Motor oder am Anschlusskasten vornehmen: **Gefahr eines elektrischen Schocks, der zum Tod führen kann.**

Unsere Motorpumpen besitzen einen thermischen Schutz, der bei Überlast oder Überhitzung der Motorspule reagiert. Dieser Schutz stellt sich automatisch wieder zurück, sobald die Spulentemperatur sinkt.

Falls die Vorschrift dies vorsieht und unabhängig vom verwendeten Motortyp, muss neben den hier aufgezählten Maßnahmen zusätzlich ein magnetisch-thermischer Schutz installiert werden, der gemäß den Angaben auf dem Motorschild kalibriert werden muss.

Die Tabelle auf Seite 169 zeigt die verschiedenen Merkmale unserer Pumpenmotoren an.

VERWENDEN SIE NUR ORIGINAL-ERSATZTEILE VON HAYWARD®

Elektrischer Anschluss: Sicherstellen, dass die für den Motor erforderliche Versorgungsspannung der des Versorgungsnetzes entspricht und dass Stromkabelabschnitt und -länge der Leistung und Intensität der Pumpe entsprechen.

Sämtliche elektrischen Anschlüsse der Pumpe sowie der eventuelle Austausch des Stromkabels müssen von einem qualifizierten Fachmann durchgeführt werden, um jegliche Gefahr auszuschließen.

Beachten Sie zur Durchführung der elektrischen Anschlüsse die Angaben unter den Anschlussklemmen.

Vor dem Zuschalten der Spannung prüfen, ob die elektrischen Anschlüsse genügend angezogen und dicht sind.

Kabel durch die dafür vorgesehene Öffnung und Ferrit führen; die Stopfbuchse gewährleistet die Dichtheit rund um den Kabel, der Ferrit ist ein Filter gegen elektromagnetische Störungen.

Die eventuelle Vorverdrahtung auf einigen unserer Pumpenmodelle muss für den definitiven Anschluss der Pumpe an die Stromversorgung abgenommen werden. Diese Vorverkabelung dient lediglich werkseitigen Testzwecken während der Herstellungsphase.

INSTALLATION

Swimmingpool-Pumpe so installieren, dass so viel Druckverlust wie möglich vermieden wird. Dabei vorgeschriebenen Abstand über mindestens 3,5 m zwischen Pumpe und Becken wie in der Installationsnorm beschrieben einhalten. Die Ansaugleitung muss mit einer leicht ansteigenden Schräge in Richtung Pumpenachse installiert werden. Sicherstellen, dass die Anschlüsse fest angezogen und dicht sind. Dabei vermeiden, dass diese Schläuche zu fest angezogen werden. Bei den Kunststoffen Dichtheit ausschließlich durch Teflon sicherstellen. Der Ansaugschlauch muss einen größeren oder zumindest gleich großen Durchmesser wie der Auslassschlauch besitzen. Unbelüftete oder feuchte Stellplätze vermeiden. Für den Motor ist eine frei zirkulierende Kühlerluft notwendig. Pumpe geschützt aufstellen, um Wasserspritzer auf dem Steuerungskasten zu vermeiden.

ANWEISUNGEN ZUM STARTEN UND ANFÜLLEN: Gehäuse des Vorfilters bis auf Höhe des Ansaugschlauchs mit Wasser befüllen. Pumpe nie ohne Wasser in Betrieb nehmen. Das Wasser ist zur Kühlung und Befeuchtung des mechanischen Verschlusses notwendig. Sämtliche Ventile der Ansaug- und Ablassleitungen öffnen, ebenso die Filterentlüftung, falls vorhanden. (In den Ansaugleitungen darf keine Luft mehr vorhanden sein). Maschine starten und einige Zeit vor dem Anfüllen warten. Fünf Minuten sind eine angemessene Wartezeit vor dem Anfüllen (das Anfüllen hängt von der Ansaughöhe und der Länge des Ansaugschlauchs ab). Falls die Pumpe nicht startet oder sich nicht anfüllt, Leitfaden zur Fehlersuche lesen.

BEDIENUNG DES STEUERKASTENS

1. BESCHREIBUNG

Die drehzahlgeregelte Hayward®-Pumpe wird durch einen Steuerkasten gesteuert, der die Anzeige der Betriebseinstellungen sowie die Einstellung und Programmierung des Timer-Modus ermöglicht.

1	LED-Kontrollleuchte für Unterspannungsetzung
2	LCD-Display
3	Wahl der Geschwindigkeit
4	Wechsel zwischen Manuellem Modus / Timer-Modus
5	Einstelltasten oben/unten
6	Tasten Ein/Aus
7	Taste zur Anzeige der Einstellungen
8	LED-Kontrollleuchten für gewählte Geschwindigkeit

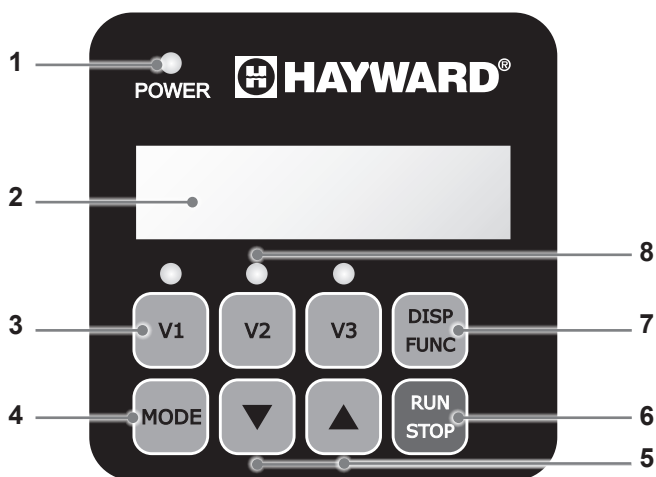

Die Pumpe wird mit **STANDARDEINSTELLUNGEN** (Werkseinstellungen) geliefert:

Ansaugung Dauer (s)	Ansaugung Geschwindigkeit (UpM)	V1 (UpM)	V2 (UpM)	V3 (UpM)	Skimmer Dauer (min)	Skimmer Zyklus (h)	Skimmer Geschwindigkeit (UpM)
240	3000	1500	2400	3000	15	1h	2800

UpM: Umdrehungen pro Minute

VERWENDEN SIE NUR ORIGINAL-ERSATZTEILE VON HAYWARD®

2. BETRIEBSARTEN DER PUMPE

2.1 Manueller Modus

Im Manuellen Modus startet oder stoppt der Benutzer die Pumpe manuell, je nach Nutzung des Schwimmbeckens.

- Mit dem Start der Pumpe beginnt eine Ansaugphase (a). Diese Phase ist regulierbar (Geschwindigkeit und Dauer, Kap. 4.2). Die Ansaugung kann beim Start unterbrochen (Kap. 3.2) oder über die Einstellungen deaktiviert werden.
- Die Pumpengeschwindigkeit stabilisiert sich anschließend auf einem konstanten Wert (b) (standardmäßig Stabilisierung bei Geschwindigkeit V2). Diese Geschwindigkeit kann durch den Benutzer ausgewählt und eingestellt werden (Kap. 3.3).
- Nach einem Stillstand/Neustart stabilisiert sich die Pumpe auf der zuletzt gespeicherten Geschwindigkeit.

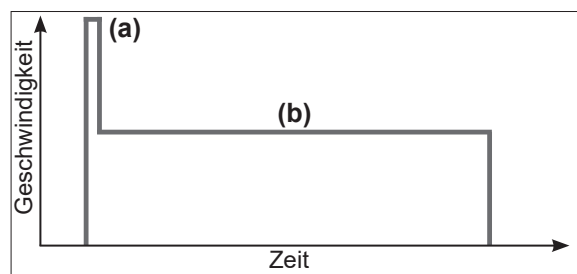

2.2 Skimmer

Die Skimmer-Funktion ermöglicht ein Abschöpfen der Wasseroberfläche, insbesondere um die Ansammlung und Stockung von Schmutz auf der Oberfläche des Schwimmbeckens zu vermeiden.

- Es handelt sich dabei um eine automatische Funktion: Die Pumpe läuft während einer einstellbaren Zeit und gemäß eines einstellbaren Zyklus mit erhöhter Geschwindigkeit (c).
- Abgesehen von dieser Geschwindigkeitserhöhung nimmt die Pumpe wieder ihre normale Geschwindigkeit auf, unabhängig davon, ob sie im Manuellen Modus oder im Timer-Modus betrieben wird.
- Die Skimmer-Funktion kann deaktiviert werden (siehe Einstellungen Kap. 4.3).

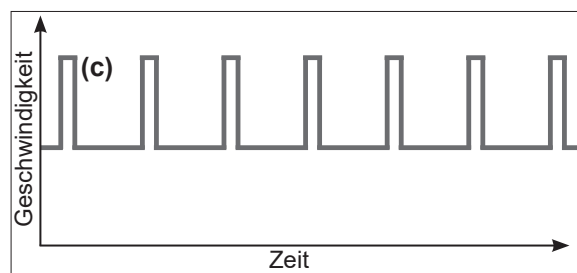

2.3 Timer-Modus

Im Timer-Modus läuft der Pumpenbetrieb rund um die Uhr automatisch. Die verschiedenen Geschwindigkeitssequenzen (d) sind vom Benutzer einzustellen. Sie werden je nach Anlage (Heizungsmodus, Energiesparer etc.) und Nutzungszeiten des Schwimmbeckens gewählt.

- Ist die Skimmer-Funktion aktiviert, überlagert sie diese Sequenzen.
- Die Pumpe kann im Timer-Modus ausgeschaltet (angehalten) werden. Beim Neustart entspricht die Geschwindigkeit der Geschwindigkeit des laufenden Timers.
- Zur Programmierung des Timer-Modus siehe Kap. 4.5.

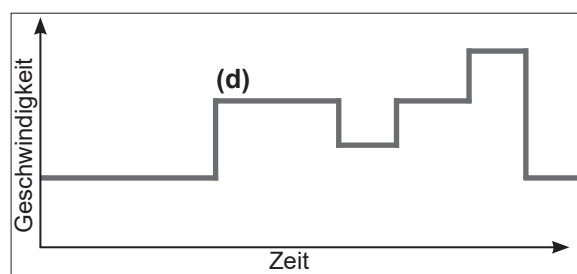

2.4 Wechseln zwischen Manuellem Modus und Timer-Modus

Die Modusänderung erfolgt durch Betätigen der Taste wie nachfolgend dargestellt:

Manueller Modus

Anzeige der Geschwindigkeit ohne Präfix →

Die leuchtende LED zeigt die gewählte Geschwindigkeit (standardmäßig V2).

Timer-Modus

Anzeige der Geschwindigkeit mit Präfix „t“ →

Die LEDs sind aus.

VERWENDEN SIE NUR ORIGINAL-ERSATZTEILE VON HAYWARD®

2.5 Anschluss der externen Digitaleingänge

⚠ ACHTUNG: Vor jedem elektrischen Eingriff an der Pumpe diese vom Stromnetz trennen und 5 min warten.

Die Filterpumpe verfügt über ein 5-Leiter-Kabel mit 3 m Länge für den Anschluss der 4 Digitaleingänge bzw. potenzialfreier Kontakte (Offen/Geschlossen).

Beispiele zur Verwendung der Digitaleingänge

- Geschwindigkeit und Durchfluss für die ordnungsgemäße Funktionsweise der Periphergeräte, wie Wärmepumpe, Rollabdeckungen oder Saugmaschine usw., zuweisen.
- Rücksteuerung für die Benutzeroberfläche installieren. Diese Digitaleingänge ermöglichen eine Fernsteuerung der Run/Stop-Funktion und der 3 Geschwindigkeiten (V1-V2-V3) über eine Distanz von 3 m.

Belegung der Kabel		
DI1	Braun	Geschwindigkeit V1
DI2	Grün	Geschwindigkeit V2
DI3	Weiß	Geschwindigkeit V3
DI4	Rot	Run/Stop
C	Schwarz	Alle

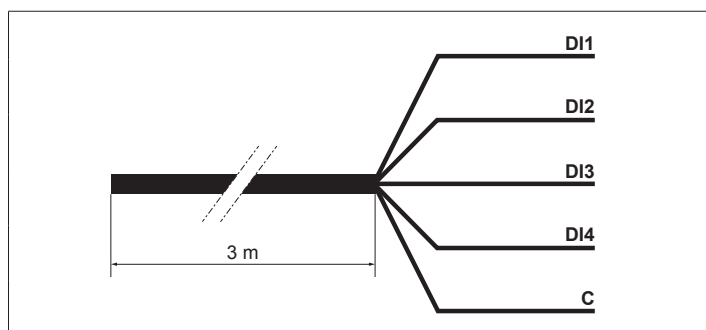

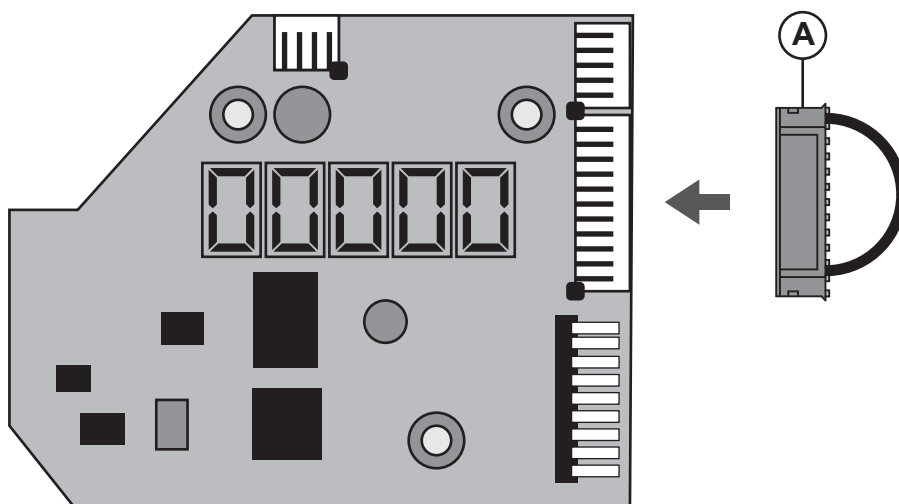

Hinweis:

- Bei teilweiser Belegung der Digitaleingänge die nicht verwendeten Leiter elektrisch isolieren.
- Bei Nichtverwendung der Digitaleingänge den Stecker (A) anstelle des 5-Leiter-Kabels einsetzen (siehe Abbildung unten).



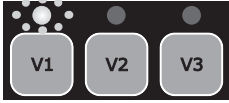

VERWENDEN SIE NUR ORIGINAL-ERSATZTEILE VON HAYWARD®

Funktionsweise mit Digitaleingängen

<p>Die Digitaleingänge können im Modus Manuell oder im Modus Timer verwendet werden. Sie besitzen eine höhere Prioritätsstufe: Sie sind MASTER über alle bei der Nutzung laufenden Funktionen. Nur die Knöpfe Run/Stop sowie DISP/FUNC bleiben aktiviert.</p>	→	
	→	
<p>Bei Verwendung eines Digitaleingangs ist ein schnelles Blinken der zur Geschwindigkeit zugehörigen LED zu sehen (DI1 = V1, DI2 = V2 oder DI3 = V3).</p>	→	

<p>Für die Funktionseingabe über die Digitaleingänge muss der Eingang DI4 geschlossen sein.</p>	→	DI4 Run/Stop Geschlossen		
<p>Werden mehrere Digitaleingänge gleichzeitig geschaltet, wird nur einer entsprechend der Rangfolge in der unten stehenden Tabelle ausgeführt.</p>		DI1 = V1	DI2 = V2	DI3 = V3
	DI1 = V1	V1	V2	V3
	DI2 = V2	V2	V2	V3
	DI3 = V3	V3	V2	V3

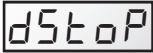
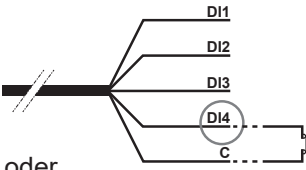
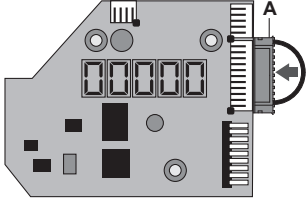
Hinweis: Wurde die Zuweisung von Vorgang und Digitaleingang abgeschlossen (Kontakt offen), nimmt die Filterpumpe wieder den entsprechenden Vorgang des laufenden Funktionsmodus auf.

<p>Ist der digitale Eingang DI4 geöffnet, läuft die Filterpumpe nicht an und auf dem Display der Pumpe erscheint dSTOP.</p> <ul style="list-style-type: none"> • Schließen Sie den Eingang DI4 . • Drücken Sie ggf. RUN/STOP, um die Filterpumpe zu starten. 	→	
	→	 <p>oder</p> 
	→	

3. BEDIENUNG

3.1 Unterspannungsetzen

Die Kontrollleuchte „Power“ leuchtet auf; das Display führt einen LCD-Test durch und zeigt anschließend die Softwareversion an.



→

→



3.2 Ansaugphase

Nach Unterspannungsetzen der Pumpe (sowie nach deren Neustart) beginnt automatisch die Ansaugphase.

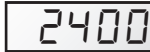
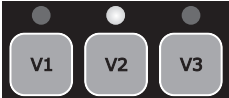

Automatischer Beginn der Ansaugphase:
 • Die Geschwindigkeit erhöht sich bis auf 3.000 UpM und wird 240 s lang gehalten (Standardwerte).

→



Ende der Ansaugphase:
 • Standardmäßig stabilisiert sich die Geschwindigkeit auf V2 oder der zuletzt gespeicherten Geschwindigkeit.
 • Die entsprechende LED leuchtet auf (Manueller Modus).

→



Um die verbleibende Ansaugzeit anzuzeigen:
 • Taste DISP/FUNC betätigen.
 • Die verbleibende Zeit wird in Sekunden angezeigt.



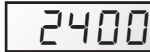
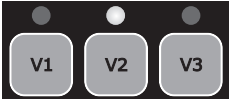

→

Um vor Ende der Ansaugphase abzubrechen:
 • Taste RUN/STOP betätigen.
 • Standardmäßig stabilisiert sich die Geschwindigkeit auf V2 oder der zuletzt gespeicherten Geschwindigkeit.

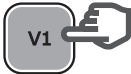

→

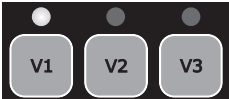

3.3 Im Manuellen Modus: Auswahl, Einstellung und Speicherung einer Geschwindigkeit

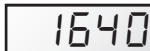

Um eine Geschwindigkeit zu wählen:
 • Eine der Geschwindigkeitstasten betätigen.
 • Der Standardwert wird angezeigt (in UpM).
 • Die entsprechende LED leuchtet auf.

→

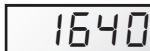

Um einen neuen Geschwindigkeitswert einzustellen:
 • Die Einstellstasten unten/oben betätigen.
 • Die LED blinkt: Einstellung erfolgt.
 • Den gewünschten Wert einstellen (von 600 bis 3.000 UpM).

→





Um einen neuen Geschwindigkeitswert zu speichern:
 • Die Geschwindigkeitstaste 3 s lang betätigen.
 • Die LED leuchtet dauerhaft, sobald die Geschwindigkeit gespeichert ist.

→





Anmerkung: Der durch die Pumpengeschwindigkeit erzeugte Wasserdurchfluss muss an die Kapazität der Anlage (Filter, Kanalisation) angepasst werden. Im Zweifelsfall an eine Fachkraft wenden.

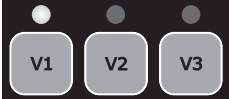

3.4 Ausschalten/Neustart der Pumpe

Um die Pumpe auszuschalten:
 • Taste RUN/STOP betätigen.
 • Die Pumpe schaltet sich aus, die Geschwindigkeits-LED leuchtet weiterhin.
 • Im Manuellen Modus zeigt das Display dauerhaft „StoP“ an. Im Timer-Modus zeigt das Display blinkend „StoP“ an.

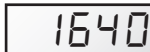
→

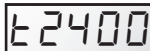

Um die Pumpe neu zu starten:
 • Taste RUN/STOP betätigen.
 • Die Pumpe startet in der Ansaugphase (Kap. 3.2).
 • Die Geschwindigkeit stabilisiert sich:
 im Manuellen Modus auf dem zuletzt gespeicherten Wert,
 im Timer-Modus auf der Geschwindigkeit des laufenden Timers.

→















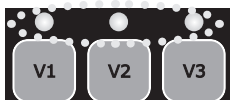

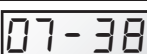
→

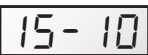

VERWENDEN SIE NUR ORIGINAL-ERSATZTEILE VON HAYWARD®

4. EINSTELLUNGEN













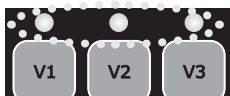

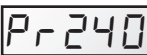



Anmerkung: Um Zugriff auf die Pumpeneinstellungen zu erhalten, muss die Pumpe unter Spannung stehen und sich im **Manuellen Modus** (Kap. 2.4) befinden. Sie kann ausgeschaltet oder in Betrieb außerhalb der Ansaugphase sein.
Wird 2 Minuten lang keine Taste betätigt, erscheint wieder die normale Anzeige (Geschwindigkeit oder StoP). Die Einstellungen werden nicht gespeichert.

4.1 Einstellen der Uhrzeit

<ul style="list-style-type: none"> • Taste DISP/FUNC 3 s lang betätigen. Die 3 LEDs blinken. • Das Display zeigt erst „Conf“, dann „hr“ an. 		 		
<ul style="list-style-type: none"> • Taste DISP/FUNC betätigen. Das Display zeigt die interne Uhrzeit (hh-min) an. 		 		
<ul style="list-style-type: none"> • Die Einstelltasten unten/oben betätigen, um die Stunden und Minuten einzustellen. 		 		 
<ul style="list-style-type: none"> • Taste RUN/STOP zum Verlassen und Speichern betätigen. Die Anzeige zeigt die aktuelle Geschwindigkeit oder StoP an. 		 		

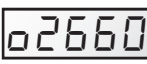
Anmerkung: Die Einstellung der internen Uhrzeit ist wichtig, falls die Pumpe im **Timer-Modus** betrieben wird. Sie bleibt gespeichert, solange die Pumpe unter Spannung steht.

4.2 Einstellen der Ansaugung

<ul style="list-style-type: none"> • Taste DISP/FUNC 3 s lang betätigen. Die 3 LEDs blinken und das Display zeigt „Conf“ an. 		 	
<ul style="list-style-type: none"> • Taste DISP/FUNC n-mal betätigen, bis auf der Anzeige „Pr 240“ erscheint: Standarddauer der Ansaugung (s). 		 	
<ul style="list-style-type: none"> • Die Einstelltasten unten/oben betätigen, um die gewünschte Dauer anzuzeigen (von 0 bis 300 s). 		 	
<ul style="list-style-type: none"> • Taste DISP/FUNC betätigen: Das Display zeigt „o3000“ an: Standardgeschwindigkeit der Ansaugung (UpM). 		 	
<ul style="list-style-type: none"> • Die Einstelltasten unten/oben betätigen, um den gewünschten Wert anzuzeigen (max. 3.000 UpM). 		 	
<ul style="list-style-type: none"> • Taste RUN/STOP zum Verlassen und Speichern betätigen. Die Anzeige zeigt die aktuelle Geschwindigkeit oder StoP an. 		 	

Anmerkung: Falls die Ansaugdauer bei Null liegt, zeigt die Anzeige „ProFF“ an: Die Ansaugung ist **deaktiviert**.







VERWENDEN SIE NUR ORIGINAL-ERSATZTEILE VON HAYWARD®

4.3 Einstellen der Skimmer-Funktion

Siehe Kap. 2.2 für Beschreibung dieser Funktion.

<ul style="list-style-type: none"> Taste DISP/FUNC 3 s lang betätigen. Die 3 LEDs blinken und das Display zeigt „ConF“ an. 		→	ConF	
<ul style="list-style-type: none"> Taste DISP/FUNC n-mal betätigen, bis auf der Anzeige „SFO.15“ erscheint: Standarddauer der Skimmer-Aktivierung (in Minuten). 		→	SFO.15	
<ul style="list-style-type: none"> Die Einstelltasten unten/oben betätigen, um die gewünschte Dauer anzuzeigen (0 bis 30 Min.). 		→	SFO20	
<ul style="list-style-type: none"> Taste DISP/FUNC betätigen: Das Display zeigt „St 1h“ an: Standarddauer des Skimmer-Zyklus. 		→	St 1h	
<ul style="list-style-type: none"> Die Einstelltasten betätigen, um den Skimmer-Zyklus auf 1 h, 2 h oder 3 h einzustellen. 		→	St 2h	
<ul style="list-style-type: none"> Taste DISP/FUNC betätigen. Das Display zeigt „S2800“ an: Standardgeschwindigkeit des Skimmers (UpM). 		→	S2800	
<ul style="list-style-type: none"> Die Einstelltasten unten/oben betätigen, um die gewünschte Geschwindigkeit anzuzeigen (600 bis 3.000 UpM). 		→	S2680	
<ul style="list-style-type: none"> Taste RUN/STOP zum Verlassen und Speichern betätigen. Die Anzeige zeigt die aktuelle Geschwindigkeit oder StoP an. 		→	1640 / StoP	
Anmerkung: Um den Skimmer zu deaktivieren, die Dauer auf Null setzen – Die Anzeige zeigt „SFoFF“ an.		→	SFO00 → SFoFF	

4.4 Zurücksetzung der Einstellungen

Um die Standardeinstellungen wieder herzustellen und die Einstellungen des Timer-Modus zu löschen, folgendermaßen vorgehen:

<ul style="list-style-type: none"> Taste DISP/FUNC 3 s lang betätigen. Die 3 LEDs blinken und das Display zeigt „ConF“ an. 		→	ConF	
<ul style="list-style-type: none"> Taste DISP/FUNC n-mal betätigen, bis auf der Anzeige „Init“ erscheint. 		→	Init	
<ul style="list-style-type: none"> Die Einstelltaste oben 3 s lang betätigen. Auf der Anzeige erscheint „donE“, wenn die Zurücksetzung erfolgt ist. 		→	donE → StoP	

Zur Erinnerung: Standardeinstellungen und Einstellbereiche

	Ansaugung		Geschwindigkeitstasten			Skimmer-Funktion			Timer-Funktion			
	Pr	o _ _ _	V1	V2	V3	SF	St	S _ _ _	t0	t1	t5	
Einheit	s	rpm	rpm	rpm	rpm	min	h	rpm	hh-min	rpm	hh-min	rpm
Standardmäßig	240	3000	1500	2400	3000	15	1	2800	06-00	2400	oFF	0
Mini	0 (oFF)	600	600	600	600	0 (oFF)	1 ...	600	00-00	—	00-00	0/ 600
Maxi	300	3000	3000	3000	3000	30	... 3	3000	24-00	—	24-00	3000

VERWENDEN SIE NUR ORIGINAL-ERSATZTEILE VON HAYWARD®

4.5 Programmieren des Timer-Modus

Mithilfe des Steuerkastens lassen sich mehrere Sequenzen (siehe Kap. 2.3) oder Timer t0 bis t5 programmieren, die nicht unbedingt der chronologischen Reihenfolge entsprechen müssen. Nicht verwendete Timer werden deaktiviert.

Der Timer „t0“ kann auf 00:00, 06:00 (standardmäßig), 12:00 oder 18:00 eingestellt werden. Er kann nicht deaktiviert werden.

Die Geschwindigkeit des Segments t0 lässt sich nicht einstellen. Sie ist festgelegt auf 2.400 UpM.

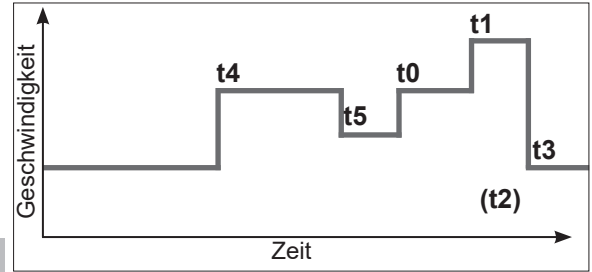



















- Zeichnen Sie das Geschwindigkeitsprofil, das Sie programmieren möchten. Die nebenstehende Abbildung dient als Beispiel.
- Prüfen Sie, ob die interne Uhrzeit korrekt eingestellt wurde.

<ul style="list-style-type: none"> • Taste DISP/FUNC 3 s lang betätigen. Die 3 LEDs blinken und das Display zeigt „ConF“ an. 		→	ConF			
<ul style="list-style-type: none"> • Taste DISP/FUNC zweimal betätigen, bis die Anzeige „t0“ erscheint. 		→	t0			
<ul style="list-style-type: none"> • Taste DISP/FUNC betätigen. Das Display zeigt „06-00“ an: Standardwert t0. 		→	06-00			
<ul style="list-style-type: none"> • Einstelltasten betätigen, um gewünschte t0 festzulegen (00-00, 06-00, 12-00 oder 18-00). 		→	18-00			
<ul style="list-style-type: none"> • Taste DISP/FUNC betätigen. Das Display zeigt „t1oFF“ an. 		→	t1oFF			
<ul style="list-style-type: none"> • Um diesen Timer zu aktivieren (Beispiel), die Taste „oben“ betätigen. Das Display zeigt „t1 on“ an. 		→	t1 on			
<ul style="list-style-type: none"> • Taste DISP/FUNC betätigen. Das Display zeigt „00-00“ an. 		→	00-00			
<ul style="list-style-type: none"> • Die Einstelltasten unten/oben betätigen, um die gewünschte Uhrzeit (hh-mm) einzustellen. 		→	20-00		→	20-15
<ul style="list-style-type: none"> • Taste DISP/FUNC betätigen. Das Display zeigt „0“ an. 		→	0			
<ul style="list-style-type: none"> • Die Einstelltasten unten/oben betätigen, um die gewünschte Geschwindigkeit (600 bis 3.000 UpM oder null) anzuzeigen. 		→	2740			
<ul style="list-style-type: none"> • Um zum nächsten Timer zu gelangen, Taste DISP/FUNC betätigen. Das Display zeigt „t2off“ an. Im Beispiel bleibt dieser Timer deaktiviert. 		→	t2oFF			
<ul style="list-style-type: none"> • Taste DISP/FUNC betätigen, um zum nächsten Timer zu gelangen und die Einstellschritte wiederholen (Aktivierung, Uhrzeit Timer und Geschwindigkeit). 		→	t3oFF etc ...			
<ul style="list-style-type: none"> • Taste RUN/STOP zum Verlassen und Speichern betätigen. Die Anzeige zeigt die aktuelle Geschwindigkeit oder StoP an. 		→	1640 / StoP			

VERWENDEN SIE NUR ORIGINAL-ERSATZTEILE VON HAYWARD®

5. ANZEIGE DER EINSTELLUNGEN

Anmerkung: Die Pumpe muss unter Spannung stehen, in Betrieb außerhalb der Ansaugphase oder ausgeschaltet sein. Um die Einstellungen zu durchlaufen, die Taste DISP/FUNC betätigen. Falls 15 s lang keine Taste betätigt wird, kehrt das Display zur normalen Anzeige zurück (aktuelle Geschwindigkeit oder Stop).

<ul style="list-style-type: none"> Taste DISP/FUNC betätigen. Das Display zeigt „hr“ an. Taste erneut betätigen: Anzeige der internen Uhrzeit. 	 → hr	 → 11-45
<ul style="list-style-type: none"> Taste DISP/FUNC betätigen. Das Display zeigt „t0“ an. Taste erneut betätigen: Anzeige der Uhrzeit von t0 (Geschwindigkeit von t0 ist auf 2.400 UpM festgelegt). 	 → t0	 → 12-00
<ul style="list-style-type: none"> Taste DISP/FUNC betätigen. Das Display zeigt „t1“ an. Taste erneut betätigen: Anzeige der Uhrzeit dieses Timers (hh-mm). 	 → t1	 → 09-20
<ul style="list-style-type: none"> Taste DISP/FUNC betätigen. Anzeige der Geschwindigkeit dieses Timers (in UpM). 	 → 1240	
<ul style="list-style-type: none"> Taste DISP/FUNC betätigen etc.: Anzeige der folgenden Timer, Uhrzeit und Geschwindigkeit, bis Timer „t5“. <p>Anmerkung: Deaktivierte Timer werden nicht angezeigt.</p>	 → t2	etc ...
<ul style="list-style-type: none"> Taste DISP/FUNC betätigen. Anzeige „P - - - -“. Verbrauchsleistung (in W, Wert bis +/- 10 %) <p>Anmerkung: P = 0 W, wenn die Pumpe ausgeschaltet ist.</p>	 → P 634 / P 0	
<ul style="list-style-type: none"> Taste DISP/FUNC betätigen. Anzeige „h - - - -“. Stundenzähler der Pumpe <p>Anmerkung: Ein Zählerdurchlauf entspricht 9.999 h.</p>	 → h2857	
<ul style="list-style-type: none"> Taste DISP/FUNC betätigen. Anzeige „- - - - -“. Gesamtenergieverbrauch (in kWh) <p>Anmerkung: Ein Zählerdurchlauf entspricht 99.999 kWh.</p>	 → 06542	
<ul style="list-style-type: none"> Taste DISP/FUNC betätigen. Anzeige „- - - - -“. Teilenergieverbrauch (in kWh), ab letzter Zurücksetzung 	 → 00086	
<ul style="list-style-type: none"> Um den Teilenergiezähler zurückzusetzen: 3 s lang eine der Einstelltasten oben/unten betätigen. Die Nachricht „CLEAR“ zeigt an, dass der Zähler zurückgesetzt wurde. 	   >3s → CLEAR	
<ul style="list-style-type: none"> Taste DISP/FUNC betätigen. Anzeige „SF On“ oder „SFOFF“ für aktivierten/deaktivierten Skimmer. 	 → SF On / SFOFF	
<ul style="list-style-type: none"> Taste DISP/FUNC betätigen. Anzeige „t - -“ Temperatur des Leistungsmoduls (in °C) 	 → t 74	
<ul style="list-style-type: none"> Taste DISP/FUNC betätigen, um zur normalen Anzeige zurückzukehren (aktuelle Geschwindigkeit oder Stop). 	 → 1640 / 5toP t2400 / :5toP	

INSTANDHALTUNG

1. Ziehen Sie die Pumpe komplett von der Netzstromversorgung ab, bevor Sie den Deckel öffnen und den Vorfilter reinigen. Vorfilterkorb regelmäßig reinigen, nicht auf den Korb schlagen, um ihn zu reinigen. Dichtung des Vorfilterdeckels prüfen und gegebenenfalls ersetzen.
2. Die Motorachse ist auf selbst schmierenden Lagern montiert, die keiner weiteren Schmierung bedürfen.
3. Motor sauber und trocken halten und sicherstellen, dass die Lüftungsöffnungen nicht verstopft sind.
4. Der mechanische Verschluss kann gelegentlich undicht werden und muss in diesem Fall ersetzt werden.
5. Abgesehen von der Reinigung des Schwimmbeckens müssen sämtliche Reparatur-, Instandhaltungs- oder Wartungsarbeiten unbedingt durch einen zugelassenen Hayward®-Reparateur oder eine andere qualifizierte Person durchgeführt werden.

Verschleißteile der unten genannten Pumpe sollten entsprechend ihrer geschätzten Lebensdauer gewartet werden:

Geschätzte lebensdauer der verschleissteile:

Wellendichtung	1 jahr
Motorlagersatz	1 jahr
Dichtungssatz (vorfilter, gehäuse, anschlüsse, ablauf)	2 jahre
Kondensator	2 jahre

ÜBERWINTERUNG

1. Pumpe leeren durch Abnehmen sämtlicher Ablassstopfen, diese im Vorfilterkorb aufbewahren.
2. Pumpe abtrennen, Schlauchanschlüsse abnehmen und komplettes Set an einem trockenen, gut belüfteten Ort aufbewahren bzw. mindestens folgende Vorsichtsmaßnahme durchführen: Pumpe abtrennen, die 4 Befestigungsbolzen des Pumpengehäuses am Motorträger abnehmen und alle Bestandteile an einem trockenen, gut belüfteten Ort aufbewahren. Daraufhin Pumpenkörper und Vorfilter durch Abdecken schützen.

HINWEIS: Vor der erneuten Inbetriebnahme der Pumpe sämtliche innere Teile durch Entfernen von Staub, Kalkablagerungen, etc. reinigen.

MÖGLICHE PANNEN UND IHRE LÖSUNGEN

A) Der Motor springt nicht an

1. Elektrische Anschlüsse, Schalter oder Relais, ebenso Stromunterbrecher oder Sicherungen prüfen.
2. Manuell sicherstellen, dass der Motor frei dreht.
3. Sicherstellen, dass die Drehzahlwerte V1, V2 und V3 nicht auf 0 U/min eingestellt sind, falls doch, auf Werkparameter zurückstellen (siehe Abschnitt 4.4).
4. Installateur kontaktieren, falls das Display einen der folgenden Fehlercodes anzeigt:

Err01	Unterspannung an Gleichstromleitung	Err10	Internes Stromversorgungsproblem
Err02	Überspannung an Gleichstromleitung	Err20	Startfehler
Err04	Überhitzung des Leistungsmoduls	Err64	Interner Kurzschluss
Err05	Überhitzung des Motors	Err97	Mehrfachproblem
Err07	Überstrom	Err98	Kommunikationsproblem
		dStop	Siehe Seite 63

B) Motor hält an, Prüfen Sie

1. Kabel, Verbindungen, Relais, etc.
2. Spannungsabfall am Motor (häufig durch zu schwache Kabel verursacht).
3. ob Verschleiß oder Überlast auftreten (durch Ablesen der aufgenommenen Ampere-Leistung).

HINWEIS: Der Motor Ihrer Pumpe ist mit einem thermischen Schutz ausgerüstet, der bei Überlast den Stromkreislauf automatisch abschaltet und damit Motorschäden vermeidet. Dieses Auslösen des Schutzes wird durch anormale Nutzungsbedingungen verursacht, welche geprüft und korrigiert werden müssen. Der Motor startet automatisch neu und ohne Eingreifen von außen, sobald die normalen Betriebsbedingungen wieder hergestellt sind.

C) 'OLOAD' erscheint auf dem Display (Überlastproblem oder Überhitzung)

1. Sicherstellen, dass die Motorwelle frei dreht
2. Sicherstellen, dass kein Schmutz das freie Drehen der Turbine behindert
3. Sicherstellen, dass der Motor ordnungsgemäß belüftet ist
4. Nach Behebung des Problems auf den Start/Stop-Knopf drücken

VERWENDEN SIE NUR ORIGINAL-ERSATZTEILE VON HAYWARD®

D) Die Pumpe füllt sich nicht an

1. Sicherstellen, dass der Vorfilterkörper voll mit Wasser gefüllt ist, die Deckeldichtung sauber und richtig angebracht ist und kein Eindringen von Luft möglich ist. Falls nötig, Feststellschrauben des Deckels nachziehen.
2. Sicherstellen, dass sämtliche Ansaug- und Ablassventile geöffnet und nicht verstopft sind und dass alle Ansaugöffnungen des Schwimmbeckens komplett unter Wasser stehen.
3. Durch Freihalten der Ansaugung so nahe wie möglich an der Pumpe prüfen, ob die Pumpe ansaugt:
 - a) falls die Pumpe trotz ausreichender Auffüllung mit Wasser nicht ansaugt
 1. Bolzen und Rohrbestandteile an der Ansaugseite nachziehen.
 2. Spannung prüfen, um sicherzustellen, dass die Pumpe mit der richtigen Geschwindigkeit läuft.
 3. Pumpe öffnen und sicherstellen, dass im Inneren nichts verstopft ist,
 4. Ausreichende Ansauggeschwindigkeit einstellen.
 5. Filter reinigen und neuen Versuch starten.
 6. Mechanischen Verschluss ersetzen.
 - b) Ansaugung im Rezirkulations-Modus versuchen. Falls die Pumpe normal ansaugt, Ansaugleitung und Vorfilter prüfen, die verstopft sein könnten oder Luft einlassen könnten.

E) Die Pumpe ist sehr laut, sicherstellen,

1. dass kein Lufteinlass oder vorhandene Luft beim Ansaugen dumpfes Knistern in der Pumpe verursacht.
2. dass kein Hohlsog durch einen zu engen Durchmesser oder eine verengte Ansaugleitung auftritt. Eine zu große Leitung am Auslass kann ebenfalls zu Hohlsog führen. Richtige Rohrgrößen verwenden oder Rohre falls nötig entlüften.
3. dass keine Vibrationen durch falsche Montage entstehen.
4. dass sich kein Fremdkörper im Pumpenkörper befindet.
5. dass die Motorlager nicht durch zu weites Spiel, durch Rost oder durch längere Überhitzung verschlissen sind.



HAYWARD®

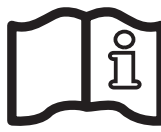
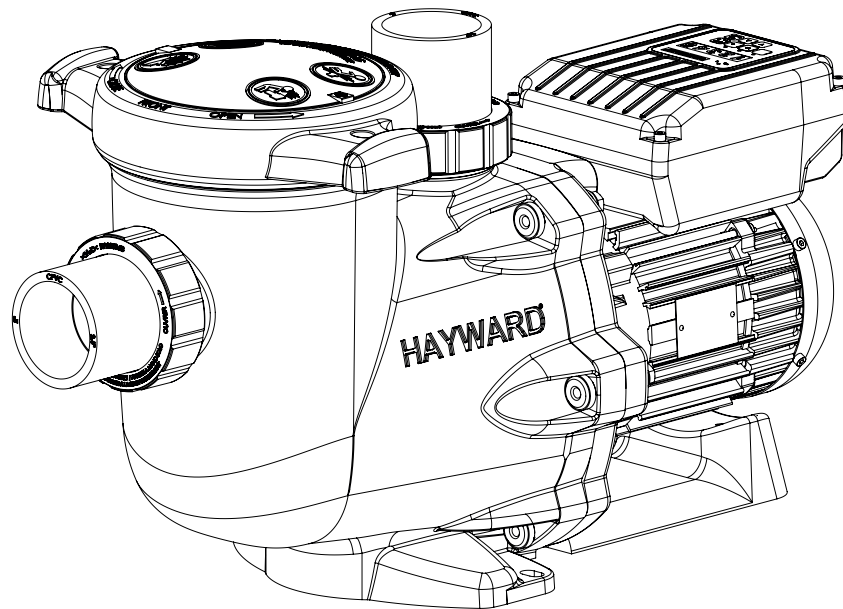

CENTRIFUGAALPOMP MET VARIABELE SNELHEID

GEBRUIKERSHANDBOEK

DIT HANDBOEK BEWAREN VOOR TOEKOMSTIG GEBRUIK



**WAARSCHUWING: elektrisch gevaar. Indien u de instructies niet respecteert, kan dit leiden tot ernstige verwondingen of overlijden.
VOOR GEBRUIK MET ZWEMBADEN**

⚠ WAARSCHUWING – Voordat u het deksel opendoet voor het schoonmaken van de filter, schakel de pomp volledig af van de stroomtoevoer.

⚠ WAARSCHUWING – Alle elektrische aansluitingen dienen door een erkende bevoegde professionele elektricien en volgens de in het land van installatie geldende normen te worden uitgevoerd of, bij gebrek daaraan, aan de internationale norm IEC 60364-7-702.

⚠ WAARSCHUWING – Zorg ervoor dat u de machine alleen aansluit op een stopcontact van 230 V_~ dat beschermd is tegen kortsluitingen. De pomp moet worden voorzien van stroom via een scheidingstransformator of via een aardlekschakelaar met een resterende werkstroom die niet hoger is dan 30 mA.

⚠ WAARSCHUWING – Houd toezicht op kinderen om te voorkomen dat ze met het apparaat gaan spelen. Houd vingers en voorwerpen uit de buurt van openingen en bewegende delen.

⚠ WAARSCHUWING – De motor moet correct geaard zijn. Verbind de aarding met de groene aardingschroef en gebruik een correct geaard stopcontact bij toestellen met netsnoer.

⚠ WAARSCHUWING – Gebruik een motoraansluitpunt met andere aansluitonderdelen met een geleider van een aangepaste maat, zoals vereist volgens de elektrische voorschriften.

⚠ WAARSCHUWING – Wanneer u deze elektrische verbindingen maakt, verwijst u naar het diagram onder de motorkap van de terminaldoos. Zorg ervoor dat u controleert of de elektrische verbindingen goed vast zitten en waterdicht zijn voordat u ze aansluit op het lichtnet. Plaats alle deksels terug voor de inschakeling.

⚠ WAARSCHUWING – Zorg ervoor dat de stroomtoevoer in een geschikt voltage wordt aangesloten en overeenkomt tussen de motor en het lichtnet en dat de kabels voor stroomtoevoer overeenkomen met het vermogen en de stroom van de pomp.

⚠ WAARSCHUWING – Lees en volg alle instructies in deze gebruikershandleiding en op de apparatuur. Als u de instructies niet volgt, kan dat leiden tot verwondingen. Dit document dient aan de eigenaar van het zwembad te worden overhandigd en moet door de eigenaar op een veilige plaats worden bewaard.

⚠ WAARSCHUWING – Dit apparaat mag alleen gebruikt worden door kinderen van 8 jaar en ouder en personen met mindere fysieke, zintuiglijke of mentale vaardigheden of met een gebrek aan ervaring en kennis, indien zij onder toezicht staan/instructies hebben ontvangen en de gevaren begrijpen die van toepassing zijn. Kinderen mogen niet met het apparaat spelen. Schoonmaak en onderhoud mag niet door kinderen uitgevoerd worden tenzij ze ouder dan 8 jaar zijn en onder toezicht staan. Houd het apparaat en het snoer buiten het bereik van kinderen onder de 8 jaar.

⚠ WAARSCHUWING – De pomp is bedoeld voor continu gebruik bij maximale watertemperatuur 35°C.

⚠ WAARSCHUWING – Gebruik uitsluitend originele Hayward® wisselstukken.

⚠ WAARSCHUWING – Als het stroomsnoer beschadigd is, moet het worden vervangen door de fabrikant, diens onderhoudsagent of ander bevoegd personeel om gevaar te vermijden.

⚠ WAARSCHUWING – Om de pomp af te sluiten van de algemene stroomtoevoer moet er een externe schakelaar voorzien worden in de vaste bekabeling die voldoet aan de bekabelingsnormen. De schakelaar moet beschikken over een contactscheiding in alle polen en kunnen zorgen voor een volledige afsluiting wanneer er zich een overspanning van categorie III voordoet.

⚠ WAARSCHUWING – Bedien de pomp van het zwembad niet als het stroomsnoer of de behuizing van doos voor de motoraansluiting beschadigd is. Dit kan immers zorgen voor een elektrische schok. Een beschadigd stroomsnoer of een beschadigde behuizing van de doos voor de motoraansluiting moet onmiddellijk worden vervangen door een onderhoudsagent of een gelijkaardig bevoegde persoon om een gevaarlijke situatie te voorkomen.

⚠ WAARSCHUWING – De motor van dit zwembad is NIET uitgerust met een afzuigbeveiligingssysteem. Het afzuigbeveiligingssysteem helpt verdrinken door het klemgeraken van het lichaam op onderwaterleidingen te voorkomen. Bij bepaalde zwembadconfiguraties, als het lichaam van een persoon de leiding bedekt, kan de persoon vastzitten door de zuigkracht. Afhankelijk van de configuratie van uw zwembad, is het mogelijk dat er een afzuigbeveiligingssysteem nodig is om te voldoen aan de lokale vereisten

⚠ WAARSCHUWING – Deze pomp bevat een batterij die om veiligheidsredenen elke manipulatie moet uitvoeren door een geautoriseerde technische dienst..

ENKEL ORIGINELE RESERVEONDERDELEN VAN HAYWARD® GEBRUIKEN.

ALGEMEEN:

Gefeliciteerd, u hebt zojuist een Hayward®-pomp met variabele snelheid gekocht.

De Hayward®-pompen met variabele snelheid beschikken over een motor met permanente magneet en elektronische AC-schakeling van de laatste generatie. Deze motor wordt aangestuurd met een microprocessor gekoppeld aan een frequentieregelaar met de volgende kenmerken:

- Weergave van de rotatiesnelheid op het controlescherm
- 3 rotatiesnelheden die in de fabriek ingesteld zijn (knoppen V1, V2, V3), snelheden instelbaar door de gebruiker
- Systematische activering bij iedere start, snelheid en instelbare activeringsduur
- Skimmer-functie, afschuimen van het wateroppervlak
- Programmeerbare Timer-functie
- Weergave van het huidig verbruikte vermogen
- Weergave van het totale en gedeeltelijke energieverbruik
- Weergave van de werkingstijd van de pomp
- laag geluidsniveau
- TEFC IP55-constructienorm

De pomp op een correcte afstand van het zwembad installeren om de verbinding tussen de aanzuiging en de pomp zoveel mogelijk te beperken om onnuttige en overmatige ladingverliezen op het hydraulische circuit te beperken.

Het is in elk geval verplicht om de veiligheidsafstand van de toepasselijke installatienorm (minimum 3.5 meter) na te leven. Installeer en gebruik het product op een hoogte van minder dan 2000m.

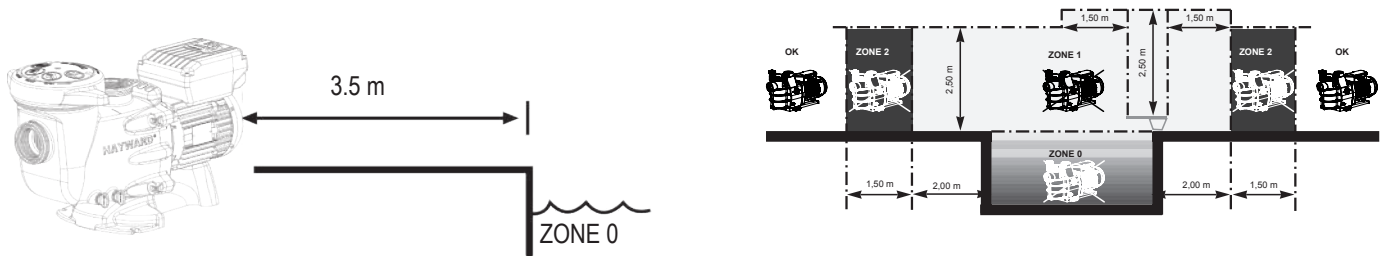

De pomp in een verluchte en droge ruimte installeren, de lucht moet vrijelijk rond de motor kunnen circuleren zodat hij op natuurlijke wijze verlucht kan worden. Voorzie een ruimte van minimum 0,5 m rond de pomp. Regelmatig controleren of de motorcooling niet verhinderd wordt door voorwerpen, bladeren of andere obstakels.

De pomp moet zodanig geïnstalleerd worden dat de externe ontkoppelingsschakelaar in de vaste kast zichtbaar en gemakkelijk toegankelijk is. De schakelaar moet zich in de buurt van de pomp bevinden.

De pomp moet permanent op een betonnen voetstuk geïnstalleerd worden met behulp van slotschroeven met \varnothing 8 mm voor beton, die vastgeschroefd worden op de plaats van de installatiegaten. Er moeten sluitringen gebruikt worden om het loskomen van de slotschroeven doorheen de tijd te voorkomen. Indien de pomp op een houten vloer gemonteerd moet worden, moeten houtschroeven met zeskantkop met \varnothing 8 mm gebruikt worden – alsook sluitringen om het loskomen van de slotschroeven doorheen de tijd te voorkomen.

De pomp beschut installeren zodat de bedieningskast niet aan opspattend water blootgesteld wordt.

De geluidsdruk van de Hayward®-pompen is minder dan 70 dBA.

Benodigde voorzieningen:

- De pomp op de aarding aansluiten: de pomp nooit gebruiken zonder dat hij op de aarding aangesloten is.
- De pomp met een kabel van type H07RN-F 3G1,5mm² aansluiten.
- Een differentiële beschermingsvoorziening van 30 mA voorzien om personen te beschermen tegen elektrische schokken veroorzaakt door een eventuele onderbreking in de elektrische isolatie van de uitrusting.
- Een beschermingsvoorziening tegen kortsluitingen voorzien (het model is gebaseerd op de waarde op het motorplaatje).
- Een uitrusting voorzien om los te koppelen van de netvoeding met een openingsafstand van de contacten van alle polen die garant staat voor een volledige onderbreking volgens de voorwaarden van overspanningscategorie III.

⚠ OPGELET: 5 minuten wachten na de pomp volledig van het elektriciteitsnetwerk ontkoppeld te hebben alvorens een interventie aan de motor of de aansluitkast uit te voeren: **risico op elektrische schok die tot overlijden kan leiden.**

De elektrische motors waar onze pompen mee uitgerust zijn, zijn voorzien van een thermische bescherming. Deze bescherming reageert bij een overbelasting of abnormale verhitting van de motorwikkeling. Deze bescherming wordt automatisch gereset wanneer de temperatuur van de wikkeling daalt.

Indien de regelgeving dit oplegt en ongeacht het type gebruikte motor, moet u naast de hierboven vermelde voorzieningen een magnetothermische bescherming installeren die volgens de informatie op het motorplaatje gekalibreerd moet worden. In de tabel op pagina 169 staan de verschillende kenmerken van de motor waarmee onze pompen uitgerust zijn.

ENKEL ORIGINELE RESERVEONDERDELEN VAN HAYWARD® GEBRUIKEN.

Elektrische aansluiting: Controleren of de voedingsaansluiting vereist voor de motor overeenstemt met die van het distributienetwerk en of de doorsnede en de lengte van het voedingsnoer aangepast zijn aan het vermogen en de intensiteit van de pomp.

Alle elektrische aansluitingen van de pomp alsook de eventuele vervanging van het voedingsnoer moeten uitgevoerd worden door een bevoegde professional om elk gevaar te vermijden.

Om deze elektrische aansluitingen uit te voeren, moet u de informatie onder de aansluitklemmen naleven.

De vastheid en dichtheid van de elektrische aansluitingen controleren alvorens de motor te voeren.

De kabel door de hiertoe voorziene opening en metalen structuur plaatsen; de pakkingbus staat in voor de dichtheid rond de kabel, de metalen structuur vormt een filter die elektromagnetische storingen tegenhoudt.

De eventuele voorbekabeling waarmee bepaalde van onze pompen uitgerust zijn, moet tijdens het definitief aansluiten van de pomp op de elektrische voeding verwijderd worden. Deze vooruitrusting wordt immers uitsluitend gebruikt voor de tests in de fabriek tijdens de productiefases.

INSTALLATIE

De zwembadpomp installeren door de ladingverliezen zoveel mogelijk te beperken en de afstanden na te leven, namelijk minimum 3,5 m tussen de pomp en het zwembad zoals verduidelijkt in de installatienorm. De aanzuigleiding moet met een kleine stijgende helling in de richting van de pompas geïnstalleerd worden. Controleren of de aansluitingen goed vastzitten en waterdicht zijn. Zorgen dat deze leidingen niet overmatig geblokkeerd worden. Voor plastic materialen de dichtheid alleen met Teflon bewerkstelligen. De aanzuigleiding zal een diameter hebben die ongeveer gelijk is aan die van de persleiding. Niet-verluchte of vochtige locaties vermijden. Voor de motor moet de koellucht vrijelijk kunnen circuleren. De pomp beschermt installeren zodat de bedieningskast niet aan opspattend water blootgesteld wordt.

START- EN AANZUIGINSTRUCTIES: Het lichaam van de voorfilter met water vullen tot de aanzuigleiding. De pomp nooit zonder water gebruiken, dit water is nodig voor het koelen en smeren van de mechanische afsluiter. Alle kleppen van de aanzuig- en persleidingen openen alsook de ontluchtingsvoorziening van de filter indien aanwezig (alle lucht moet uit de aanzuigleidingen verwijderd worden). De groep starten en voldoende lang wachten totdat het aanzuigen begint. Vijf minuten wachten tot het aanzuigen begint, is niet overdreven lang (de wachttijd voor het aanzuigen is afhankelijk van de aanzuighoogte en de lengte van de aanzuigleiding). Indien de pomp niet start of niet aanzuigt, de gids voor het opsporen van storingen raadplegen.

GEBRUIK VAN DE BEDIENINGSDOOS

1. PRESENTATIE

De Hayward pomp met variabele snelheid® wordt bediend via een bedieningsdoos waarmee de werkingsinstellingen weergegeven en ingesteld kunnen worden en de Timer-modus geprogrammeerd kunnen worden.

1	LED-lampje voor inschakeling
2	LCD weergavescherm
3	Snelheidskeuze
4	Schakelen tussen Manuele modus / Timer-modus
5	Instelknoppen omhoog / omlaag
6	Start / Stop knop
7	Weergaveknop voor de instellingen
8	LED-lampjes voor gekozen snelheid

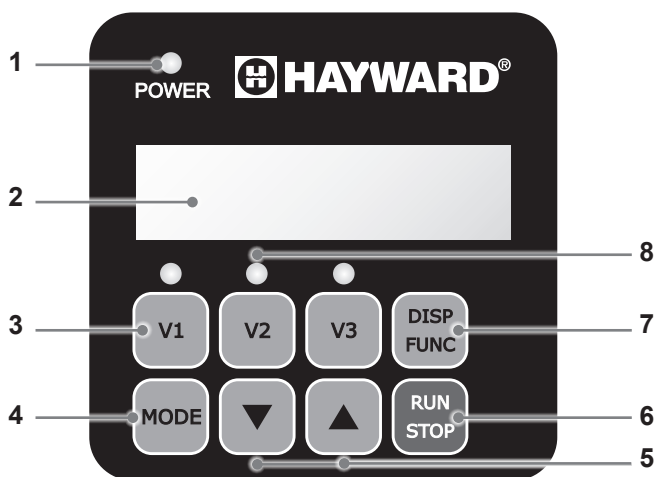

De pomp wordt geleverd met **STANDAARD INSTELLINGEN** (fabrieksinstellingen):

Activering duur (sec)	Activering snelheid (tpm)	V1 (tpm)	V2 (tpm)	V3 (tpm)	Skimmer duur (min)	Skimmer cyclus (u)	Skimmer snelheid (tpm)
240	3000	1500	2400	3000	15	1u	2800

tpm: toeren per minuut

ENKEL ORIGINELE RESERVEONDERDELEN VAN HAYWARD® GEBRUIKEN.

2. WERKINGSMODI VAN DE POMP

2.1 Manuele modus

In de Manuele modus start of stopt de gebruiker de pomp manueel, in functie van het gebruik van het zwembad.

- Het starten van de pomp start een activatiemodus (a). Deze fase is instelbaar (snelheid en duur, § 4.2). De activatie kan onderbroken worden bij het starten (§ 3.2) of uitgeschakeld worden door de instellingen.
- De pompsnelheid stabiliseert vervolgens op een constante waarde (b) (standaard stabilisatie op snelheid V2). Deze snelheid kan gekozen en ingesteld worden door de gebruiker (§ 3.3).
- Na een stop/herstart stabiliseert de pomp zich op de laatste opgeslagen snelheid.

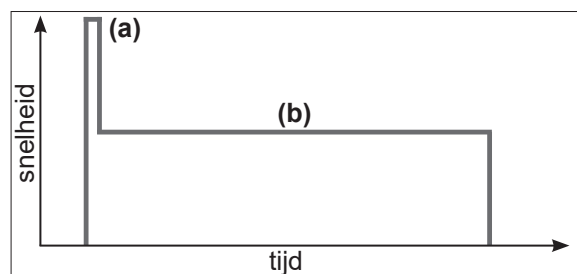

2.2 Skimmer

Met de Skimmer-functie kan het wateroppervlak afgeschuimd worden om het ophopen en stremmen van vuil aan de oppervlakte van het zwembad te vermijden.

- Dit is een automatische functie: de pomp werkt aan een hogere snelheid (c) tijdens een instelbare duur en cyclus.
- Buiten deze snelheidsverhoging, werkt de pomp aan de normale snelheid, of dit nu in Manuele of in Timer-modus is.
- De Skimmer-functie kan uitgeschakeld worden (zie instellingen § 4.3).

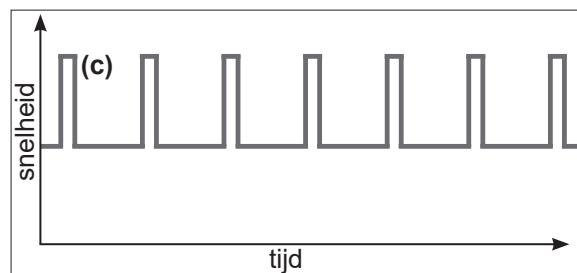

2.3 Timer-modus

In de Timer-modus werkt de pomp automatisch 24/24. De verschillende snelheidsreeksen (d) zijn in te stellen door de gebruiker. Ze worden gekozen in functie van de installatie (verwarmingsmodus, energiebesparing, enz...) en de gebruiksuren van het zwembad.

- De Skimmer-functie is geactiveerd, ze plaatst zich boven deze reeksen.
- De pomp kan uitgeschakeld worden (gepauzeerd) in Timer-modus. Bij een herstart is de snelheid dezelfde als die van de huidige Timer.
- Om de Timer-modus te programmeren, raadpleegt u § 4.5.

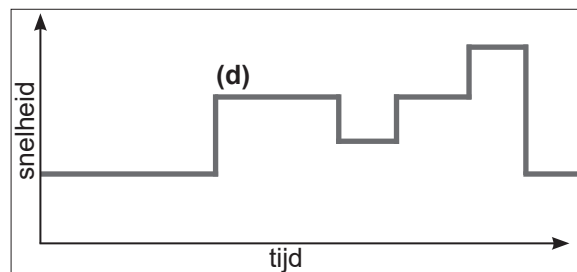

2.4 Schakelen tussen de Manuele modus / Timer-modus

Het wijzigen van de modus gebeurt door te drukken op knop  zoals hieronder getoond:

Manuele modus

Weergave snelheid zonder voorvoegsel



Het opgelichte LED toont de gekozen snelheid (standaard V2)



Timer-modus

Weergave snelheid met voorvoegsel "t"



De LED's zijn uitgeschakeld



2.5 Aansluiting van externe digitale ingangen

⚠ OPGELET: Voordat aan de elektriciteit van de pomp wordt gewerkt, moet u de pomp loskoppelen van het elektriciteitsnet en 5 minuten wachten.

De filterpomp is uitgerust met een 3 m lange kabel met 5 draden waarmee 4 digitale ingangen of potentiaalvrije droge contacten (open/gesloten) worden aangesloten.

Voorbeelden van gebruik van digitale ingangen

- Wijs de snelheid en het debiet toe die nodig zijn voor een goede werking van de perifere organen, zoals een warmtepomp, een rolluik of een robotstofzuiger enz.
- Installeer een besturingskabel van de gebruikersinterface. Via deze digitale ingangen kunnen de functie Run/Stop en de 3 snelheden (V1-V2-V3) op een afstand van 3 meter worden gestuurd.

Toewijzing van de draden		
DI1	Bruin	Snelheid V1
DI2	Groen	Snelheid V2
DI3	Wit	Snelheid V3
DI4	Rood	Run/Stop
C	Zwart	Gemeenschappelijk

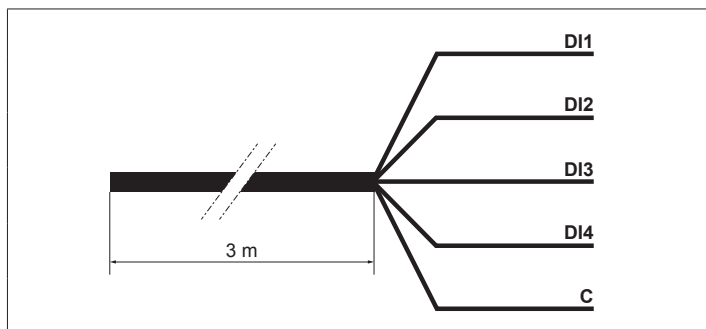

Opmerking:

- in geval van gedeeltelijk gebruik van de digitale ingangen, de niet gebruikte draden elektrisch isoleren.
- In geval de digitale ingangen niet worden gebruikt, plaatst u de connector (A) in plaats van de kabel met 5 draden (zie onderstaande afbeelding).

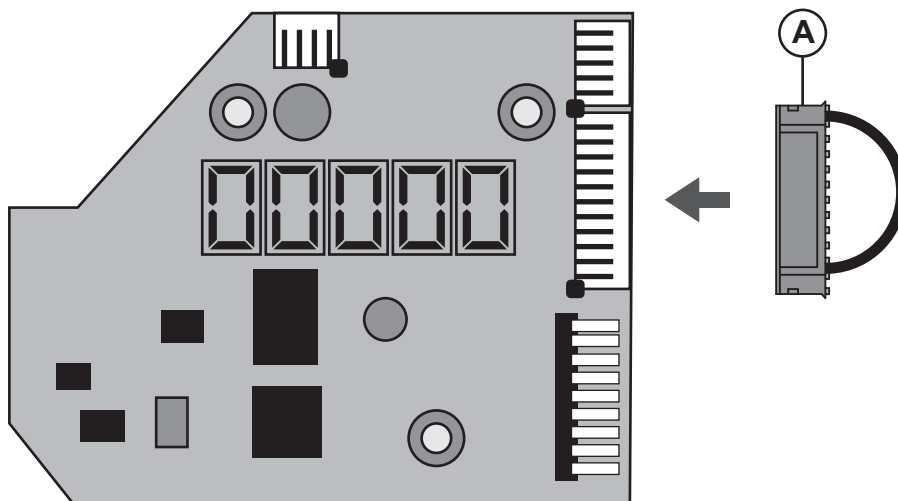

ENKEL ORIGINELE RESERVEONDERDELEN VAN HAYWARD® GEBRUIKEN.

Werking met de digitale ingangen

De digitale ingangen kunnen worden gebruikt in de handmatige of timermodus. Ze bevinden zich op het hoogste prioriteitsniveau: ze zijn MASTER van alle functies die worden gebruikt. Alleen de knoppen Run/Stop en DISP/FUNC blijven actief.	→	
	→	
Wanneer een digitale ingang wordt gebruikt, gaat de LED die aan de betreffende LED is gekoppeld, snel knipperen (DI1 = V1, DI2 = V2 of DI3 = V3).	→	

Om een actie tussen de digitale ingangen te verkrijgen, moet de ingang DI4 worden gesloten.	→	DI4 Run/StopGesloten		
Als er meerdere digitale ingangen simultaan zijn omgeschakeld, wordt één ingang uitgevoerd in volgorde van de prioriteit die in de tabel hiernaast is gedefinieerd.		DI1 = V1	DI2 = V2	DI3 = V3
	DI1 = V1	V1	V2	V3
	DI2 = V2	V2	V2	V3
	DI3 = V3	V3	V2	V3

Opmerking: Zodra de actie die aan de digitale ingang is gekoppeld, is voltooid (open contact), hervat de filterpomp de actie van de actuele werkingsmodus.

Als de digitale ingang DI4 open is, start de filterpomp niet en verschijnt dSTOP op het scherm van de pomp. • Sluit ingang DI4. • Druk eventueel op RUN/STOP om de filterpomp te starten.	→	
	→	<p>or</p>
	→	

3. GEBRUIK

3.1 Inschakelen







Het lampje "Power" licht op; het scherm voert een LCD-test uit en toont vervolgens de softwareversie

→



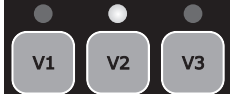



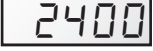
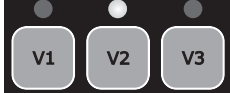

→

3.2 Activeringsfase

Na het inschakelen van de pomp, start de activeringsfase automatisch (idem na een herstart van de pomp).

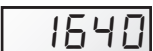
<p>Automatisch starten van de activeringsfase:</p> <ul style="list-style-type: none"> De snelheid verhoogt tot 3000 tpm en blijft gedurende 240 sec behouden (standaard waarden) 		→		
<p>Einde van de activeringsfase:</p> <ul style="list-style-type: none"> Standaard stabiliseert de snelheid zich op V2 of op de laatste opgeslagen snelheid Het overeenkomstige LED licht op (Manuele modus) 		→		
<p>Om de resterende activeringstijd weer te geven:</p> <ul style="list-style-type: none"> druk op DISP/FUNC de resterende tijd wordt weergegeven in sec 		→		
<p>Om te stoppen voor het einde van de activeringstijd:</p> <ul style="list-style-type: none"> druk op RUN/STOP Standaard stabiliseert de snelheid zich op V2, of op de laatste opgeslagen snelheid 		→		

3.3 In de Manuele modus: selecteren, instellen en opslaan van een snelheid

<p>Om een snelheid te selecteren:</p> <ul style="list-style-type: none"> druk op een van de snelheidsknoppen De standaardwaarde wordt getoond (in tpm) De overeenkomstige LED brandt 		→		
<p>Om een nieuwe snelheidswaarde in te stellen:</p> <ul style="list-style-type: none"> druk op de instelknoppen omhoog / omlaag Het LED knippert: wordt ingesteld De gewenste waarde instellen (van 600 tot 3000 tpm) 		→		
<p>Om de nieuwe snelheidswaarde op te slaan:</p> <ul style="list-style-type: none"> druk gedurende 3 sec op de snelheidsknop Het LED brandt constant wanneer de snelheid opgeslagen wordt 		→		

Opmerking: Het waterdebiet dat door de pompsnelheid gegenereerd wordt moet aangepast zijn aan de capaciteit van de installatie (filter, leidingen...). Bij twijfel doet u beroep op een professional.

3.4 Uitschakelen / Herstarten van de pomp















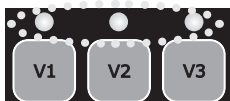

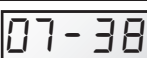
<p>Om de pomp uit te schakelen:</p> <ul style="list-style-type: none"> druk op RUN/STOP De pomp stopt, het snelheids-LED blijft branden In Manuele modus toont het scherm continu "StoP" In Timer modus toont het scherm knipperend "StoP" 		→	 	
<p>Om de pomp opnieuw te starten:</p> <ul style="list-style-type: none"> druk op RUN/STOP De pomp herstart in activatiefase (§ 3.2) De snelheid stabiliseert zich: 		→		
<p>in Manuele modus op de laatst opgeslagen waarde, in Timer-modus op de snelheid volgens de huidige Timer</p>		→		

ENKEL ORIGINELE RESERVEONDERDELEN VAN HAYWARD® GEBRUIKEN.













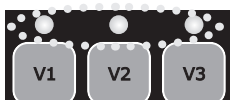

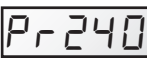



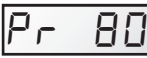

4. INSTELLINGEN

Opmerking: Om toegang te krijgen tot de instellingen moet de pomp geactiveerd zijn in **Manuele modus** (§ 2.4), bij het stoppen of starten buiten activatiemodus.
Als gedurende 2 min. geen enkele knop ingedrukt wordt, wordt de weergave normaal (snelheid of StoP) en de instellingen worden niet opgeslaan.

4.1 Instelling van het horloge

<ul style="list-style-type: none"> • Druk gedurende 3sec op DISP/FUNC De 3 LED's knipperen • Het scherm toont "ConF" en vervolgens "hr" 	 >3s	 	 	
<ul style="list-style-type: none"> • Druk op DISP/FUNC, het scherm toont het interne uur van het uurwerk (hh-min) 				
<ul style="list-style-type: none"> • Druk op de instelknoppen omlaag /omhoog om de uren / de minuten in te stellen 	 	 	 	
<ul style="list-style-type: none"> • Druk op RUN/STOP om uit het menu te gaan en op te slaan De weergave toont de huidige snelheid of StoP 			 	
<p>Opmerking: De instelling van het interne uurwerk is belangrijk als de pomp werkt in Timer modus. Het blijft opgeslagen wanneer de pomp uitgeschakeld wordt.</p>				

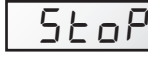
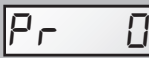
4.2 Instelling van de activatie

<ul style="list-style-type: none"> • Druk gedurende 3 sec op DISP/FUNC De 3 LED's knipperen en het scherm toont "ConF" 	 >3s			
<ul style="list-style-type: none"> • Druk op DISP/FUNC totdat het scherm "Pr 240" verschijnt: standaard activatieduur (sec) 	 x n			
<ul style="list-style-type: none"> • Druk op de instelknoppen omhoog / omlaag om de gewenste duur (van 0 sec tot 300 sec) weer te geven 	 			
<ul style="list-style-type: none"> • Druk op DISP/FUNC: het scherm toont "03000" standaard activatiesnelheid (tpm) 				
<ul style="list-style-type: none"> • Druk op de instelknoppen omhoog/omlaag om de gewenste waarde weer te geven (max 3000 tpm) 	 			
<ul style="list-style-type: none"> • Druk op RUN/STOP om uit het menu te gaan en op te slaan De weergave toont de huidige snelheid of StoP 			 	
<p>Opmerking: Als de activatieduur nul is, wordt de weergave "ProFF" : de activatie is uitgeschakeld</p>				
				

4.3 Instelling van de Skimmer-functie

Zie § 2.2 voor het weergeven van deze optie

<ul style="list-style-type: none"> Druk gedurende 3 sec op DISP/FUNC De 3 LED's knipperen en het scherm toont "ConF" 		→	Conf	
<ul style="list-style-type: none"> Druk op DISP/FUNC totdat het scherm "SFO.15" verschijnt: standaard actievatieduur van de Skimmer (in minuten) 		→	SFO.15	
<ul style="list-style-type: none"> Druk op de instelknoppen omhoog / omlaag om de gewenste duur te tonen (van 0 tot 30 min) 		→	SFO20	
<ul style="list-style-type: none"> Druk op DISP/FUNC: het scherm toont 'St 1u': standaardduur cyclus Skimmer 		→	St 1h	
<ul style="list-style-type: none"> Druk op de instelknoppen om de Skimmer cyclus in te stellen op 1u, 2u of 3u 		→	St 2h	
<ul style="list-style-type: none"> Druk op DISP/FUNC: het scherm toont "S2800": standaard snelheid van de Skimmer (tpm) 		→	S2800	
<ul style="list-style-type: none"> Druk op de instelknoppen omhoog / omlaag om de gewenste snelheid weer te geven (van 600 tot 3000 tpm) 		→	S2680	
<ul style="list-style-type: none"> Druk op RUN/STOP om uit het menu te gaan en op te slaan De weergave toont de huidige snelheid of StoP 		→	1640 / StoP	
Opmerking: Om de Skimmer uit te schakelen, zet u de duur op nul - De weergave wordt "SFoFF"		→	SFoFF	

4.4 Herstarten van de instellingen

Om de standaard instellingen te herstellen en de instellingen van de Timer-modus te wissen, doet u het volgende:

<ul style="list-style-type: none"> Druk gedurende 3 sec op DISP/FUNC De 3 LED's knipperen en het scherm toont "ConF" 		→	Conf	
<ul style="list-style-type: none"> Druk op DISP/FUNC totdat het bericht "Init" op het scherm verschijnt 		→	Init	
<ul style="list-style-type: none"> Druk op de instelknop "omhoog" gedurende 3 sec. De weergave wordt "donE" wanneer de herstart wordt uitgevoerd. 		→	donE → StoP	

Herinnering: standaard instellingen en instelbereiken

	Activatie		Snelheidsknoppen			Skimmer-functie			Timer-functie			
	P _r	o ₋₋₋	V1	V2	V3	SF	St	S ₋₋₋	t0	tpm	t1 - t5	tpm
Eenheid	s	tpm	tpm	tpm	tpm	min	h	tpm	hh-min	tpm	hh-min	tpm
Standaard	240	3000	1500	2400	3000	15	1	2800	06-00	2400	oFF	0
Mini	0 (oFF)	600	600	600	600	0 (oFF)	1 ...	600	00-00	—	00-00	0/ 600
Maxi	300	3000	3000	3000	3000	30	... 3	3000	24-00	—	24-00	3000

ENKEL ORIGINELE RESERVEONDERDELEN VAN HAYWARD® GEBRUIKEN.

4.5 Programmering van de Timer-modus

Met de bedieningsdoos kunt u meerdere reeksen programmeren (zie § 2.3) of Timers t0 tot t5, die niet noodzakelijk chronologisch moeten zijn. De niet gebruikte Timers worden uitgeschakeld.

De Timer "t0" kan vastgelegd worden tot 00:00 06:00 (standaard); 12:00 of 18:00. Het kan niet uitgeschakeld worden.

De snelheid van het segment t0 kan niet ingesteld worden, hij ligt vast op 2400 tpm

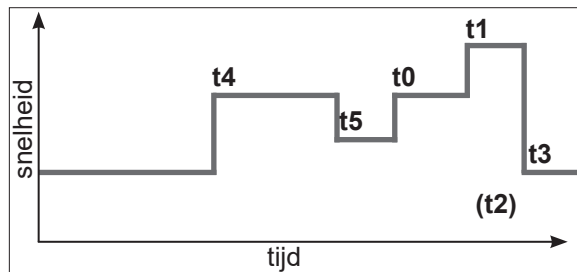



















- Traceer het snelheidsprofiel dat u wilt programmeren. De grafiek hiernaast wordt louter als voorbeeld getoond.
- Controleer of het interne uurwerk correct ingesteld is.

<ul style="list-style-type: none"> • Druk gedurende 3 sec op DISP/FUNC De 3 LED's knipperen en het scherm toont "ConF" 		→	ConF			
<ul style="list-style-type: none"> • Druk op DISP/FUNC 2 keer na elkaar totdat "t0" verschijnt 		→	t0			
<ul style="list-style-type: none"> • Druk op DISP/FUNC, het scherm toont "06-00": standaard waarde t0 		→	06-00			
<ul style="list-style-type: none"> • Druk op de instelknoppen om de gewenste t0 vast te leggen (00-00, 06-00, 12-00 of 18-00) 		→	18-00			
<ul style="list-style-type: none"> • Druk op DISP/FUNC : het scherm toont "t1oFF" 		→	t1oFF			
<ul style="list-style-type: none"> • Om deze Timer (voorbeeld) te activeren, drukt u op de knop "omhoog". Het scherm toont "t1 on" 		→	t1 on			
<ul style="list-style-type: none"> • Druk op DISP/FUNC: het scherm toont "00-00" 		→	00-00			
<ul style="list-style-type: none"> • Druk op de instelknoppen omlaag / omhoog om het gewenste uur in te stellen (hh-mm) 		→	20-00		→	20-15
<ul style="list-style-type: none"> • Druk op DISP/FUNC: het scherm toont "0" 		→	0			
<ul style="list-style-type: none"> • Druk op de instelknoppen om de gewenste snelheid in te stellen (van 600 tot 3000 tpm of nul) 		→	2740			
<ul style="list-style-type: none"> • Om naar de volgende Timer over te schakelen, drukt u op DISP/FUNC: het scherm toont "t2oFF". In het voorbeeld blijft de Timer uitgeschakeld 		→	t2oFF			
<ul style="list-style-type: none"> • Druk op DISP/FUNC om over te schakelen naar de volgende Timer en herhaal de instelstappen (activatie, uurwerk Timer en snelheid) 		→	t3oFF	enz ...		
<ul style="list-style-type: none"> • Druk op RUN/STOP om uit het menu te gaan en op te slaan De weergave toont de huidige snelheid of StoP 		→	1640 / StoP			

ENKEL ORIGINELE RESERVEONDERDELEN VAN HAYWARD® GEBRUIKEN.

5. WEERGAVE VAN DE PARAMETERS

Opmerking: De pomp blijft ingeschakeld, werkt buiten de activatiefase, of bij het stoppen.
 Om de parameters te doorlopen, drukt u op de toets DISP/FUNC.
 Als geen enkele knop gedurende 15 sec ingedrukt wordt, schakelt het scherm over naar normale weergave (huidige snelheid of Stop).

<ul style="list-style-type: none"> Druk op DISP/FUNC: het scherm toont "hr" Druk opnieuw: weergave van het interne uur 	 → hr	 → 11-45
<ul style="list-style-type: none"> Druk op DISP/FUNC: het scherm toont "t0" Druk opnieuw: uurweergave van de t0 (de snelheid van de t0 ligt vast op 2400 tpm) 	 → t0	 → 12-00
<ul style="list-style-type: none"> Druk op DISP/FUNC: het scherm toont "t1" Druk opnieuw: weergave van het uur van deze Timer (hh-mm) 	 → t1	 → 09-20
<ul style="list-style-type: none"> Druk op DISP/FUNC: weergave van de snelheid van deze Timer (in tpm) 	 → 1240	
<ul style="list-style-type: none"> Druk op DISP/FUNC enz.: weergave van de volgende Timers, uur en snelheid, tot Timer "t5" Opmerking: De uitgeschakelde Timers worden niet getoond 	 → t2	enz ...
<ul style="list-style-type: none"> Druk op DISP/FUNC : weergave "P - - - -" Verbruikt vermogen (in W, waarde tot +/- 10%) Opmerking: P = 0 W wanneer de pomp uitgeschakeld is 	 → P 634 / P 0	
<ul style="list-style-type: none"> Druk op DISP/FUNC : weergave "h - - - -" Urenteller van de pomp Opmerking: Een toerenteller toont 9999 h 	 → h2857	
<ul style="list-style-type: none"> Druk op DISP/FUNC : weergave "- - - - -" Totaal energieverbruik (in kWh) Opmerking: Een toerenteller toont 99999 kWh 	 → 06542	
<ul style="list-style-type: none"> Druk op DISP/FUNC : weergave "- - - - -" Gedeeltelijk energieverbruik (in kWh), sinds de laatste reset 	 → 00086	
<ul style="list-style-type: none"> Om de gedeeltelijke energieteller op nul te zetten: Druk 3 sec op een van de knoppen omhoog / omlaag. Het bericht "CLEAR" betekent dat de teller gereset is 	   → CLEAR <small>>3s</small>	
<ul style="list-style-type: none"> Druk op DISP/FUNC: Weergave "SF On" of "SFOFF" voor Skimmer in-/ uitgeschakeld 	 → SF On / SFOFF	
<ul style="list-style-type: none"> Druk op DISP/FUNC: Weergave "t - -" Temperatuur van de vermogenmodule (in °C) 	 → t 74	
<ul style="list-style-type: none"> Druk op DISP/FUNC om terug te keren naar de normale weergave (huidige snelheid of Stop) 	 → 1640 / 5toP	 → t2400 / :5toP

ENKEL ORIGINELE RESERVEONDERDELEN VAN HAYWARD® GEBRUIKEN.

ONDERHOUD

1. De pomp volledig van de netvoeding ontkoppelen alvorens het deksel te openen en de voorfilter te reinigen. De korf van de voorfilter regelmatig reinigen, niet op de korf kloppen om hem te reinigen. De pakking van het deksel van de voorfilter controleren en indien nodig vervangen.
2. De motoras is gemonteerd op zelfsmerende lagers die in de toekomst niet meer gesmeerd moeten worden.
3. De motor schoon en droog houden en zorgen dat de ventilatiegaten niet verstopt raken.
4. Af en toe kan de mechanische afsluiter lekken en moet hij vervangen worden.
5. Met uitzondering van het reinigen van het zwembad, moeten alle reparatie- en onderhoudsinterventies verplicht uitgevoerd worden door een bevoegde vertegenwoordiger van Hayward® of een andere gekwalificeerde persoon.

Slijtageonderdelen van de hieronder genoemde pomp moeten worden onderhouden volgens hun geschatte levensduur:

Geschatte levensduur van slijtonderdelen:

Mechanische verzegeling	1 jaar
Motorlagerset	1 jaar
Pakkingset (voorfilter, behuizing, bevestigingen, afvoer)	2 jaar
Contactstrip	2 jaar

OVERWINTEREN

1. De pomp leegmaken door de aftappluggen te verwijderen en ze in de korf van de voorfilter te bewaren.
2. De pomp ontkoppelen, de leidingaansluitingen verwijderen en de volledige groep op een droge en verluchte plaats bewaren of ten minste de volgende voorzorgsmaatregel treffen: de pomp ontkoppelen, de 4 bevestigingsbouten verwijderen waarmee het pomplichaam aan de motorsteun bevestigd is en het geheel op een droge en verluchte plaats bewaren. Het pomplichaam en de voorfilter beschermen door ze te bedekken.

OPMERKING: Alvorens de pomp opnieuw in gebruik te nemen, alle interne onderdelen reinigen door stof en afzettingen, enz. te verwijderen.

MOGELIJKE STORINGEN EN OPLOSSINGEN

A) De motor start niet

1. De elektrische aansluitingen, schakelaars of relais controleren, de circuitonderbrekers of zekeringen controleren.
2. Controleren of de motor vrijelijk kan roteren.
3. Controleren of de rotatiesnelheden 'V1', 'V2' en 'V3' niet op 0 omw/min ingesteld zijn, indien dit het geval is de fabrieksparameters herstellen (zie § 4.4).
4. Als het scherm een van de foutcodes hieronder toont, neem dan contact op met uw installateur:

Err01	Onderspanning van de continue lijn	Err10	Probleem interne elektrische voeding
Err02	Overspanning van de continue lijn	Err20	Startproblemen
Err04	Oververhitting van de vermogensmodule	Err64	Probleem interne kortsluiting
Err05	Oververhitting motor	Err97	Veelvoudig probleem
Err07	Overbelasting	Err98	Communicatieprobleem
		dStop	Zie pagina 76

B) De motor stopt, het volgende controleren.

1. De kabels, aansluitingen, relais, enz.
2. De spanningsval naar de motor (wordt vaak veroorzaakt door te zwakke kabels).
3. Of er geen vastloping of overbelasting is (door de geabsorbeerde stroomsterkte af te lezen).

OPMERKING: De motor van uw pomp is voorzien van een thermische beveiliging die, bij overbelasting, het circuit automatisch zal uitschakelen en zal vermijden dat de motor beschadigd wordt. Deze inschakeling wordt gegenereerd door abnormale werkingsomstandigheden die gecontroleerd en gecorrigeerd moeten worden. De motor zal zonder enige interventie opnieuw starten zodra de normale werkingsomstandigheden hersteld zijn.

C) 'OLOAD' verschijnt op de display (overbelasting of oververhitting).

1. Controleren of de motoras vrijelijk draait.
2. Controleren het vrijelijk roteren van de turbine niet door verontreinigingen verhinderd wordt.
3. Controleren of de motor correct verlucht wordt.
4. Na het oplossen van het probleem op de aan/uit-knop drukken.

ENKEL ORIGINELE RESERVEONDERDELEN VAN HAYWARD® GEBRUIKEN.

D) De pomp zuigt niet aan

1. Controleren of het lichaam van de voorfilter met water gevuld is, of de pakking van het deksel schoon en goed geplaatst is en of geen enkele luchtopname mogelijk is. Indien nodig de borgschroeven van het deksel opnieuw vastdraaien.
2. Controleren of alle aanzuig- en perskleppen geopend en niet-verstopt zijn en of alle aanzuigopeningen van het zwembad volledig ondergedompeld zijn.
3. Controleren of de pomp aanzuigt door het aangezogen materiaal zo dicht mogelijk in de buurt van de pomp vrij te geven.
 - a) indien de pomp niet aanzuigt ondanks een voldoende voorraad aanzuigwater.
 1. De bouten en leidingaccessoires aan aanzuigzijde opnieuw vastdraaien.
 2. De spanning verifiëren om te controleren of de pomp tegen de juiste snelheid draait.
 3. De pomp openmaken en controleren of niets binnen in aanwezig is dat verstopping veroorzaakt.
 4. Een voldoende hoge activatiesnelheid instellen
 5. Reinig de filter en probleem opnieuw
 6. De mechanische afsluiter vervangen.
 - b) Probeer opnieuw te activeren in recirculatiemodus. Indien de pomp normaal aanzuigt, de aanzuigleiding en de voorfilter controleren. Ze zouden verstopt kunnen zitten of luchtopname kunnen veroorzaken.

E) Pomp maakt lawaai, het volgende controleren.

1. Of geen enkele luchtopname of -aanwezigheid tot geklapper in de pomp leidt.
2. Of er geen cavitatie veroorzaakt wordt door een onvoldoende diameter of een beperking van de aanzuigleiding. Een te grote persleiding kan eveneens tot cavitatie leiden. Of correcte leidingen gebruikt worden of de leidingen indien nodig ontluchten.
3. Of geen trillingen ontstaan door een verkeerde montage.
4. Of zich geen vreemde voorwerpen in het pomplichaam bevinden.
5. Of de motorlagers niet vastlopen door een te grote speling, roest of aanhoudende oververhitting.



HAYWARD®

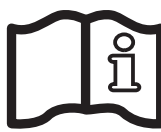
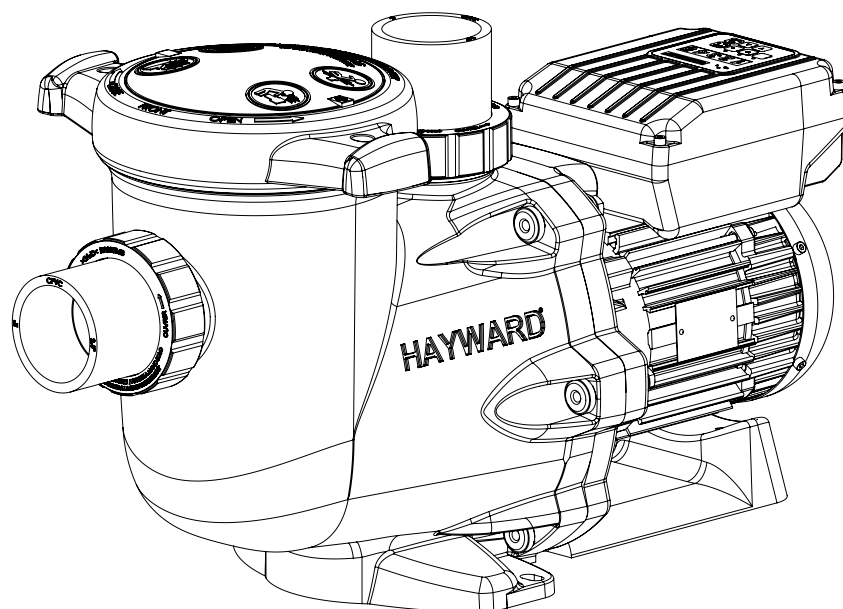

POMPA CENTRIFUGA A VELOCITÀ VARIABILE

MANUALE PER L'USO

CONSERVARE QUESTO MANUALE PER L'USO PER LA FUTURA CONSULTAZIONE



AVVERTENZA: Rischio elettrico. La mancata osservanza delle istruzioni può essere causa di gravi lesioni o morte.
UTILIZZO IN PISCINE

⚠ **AVVERTENZA** – Prima di aprire il coperchio per effettuare la pulizia del filtro, scollegare completamente la pompa dalla rete di alimentazione principale.

⚠ **AVVERTENZA** – I collegamenti elettrici devono essere effettuati esclusivamente da un professionista autorizzato e qualificato, nel pieno rispetto della normativa in vigore nel paese di installazione o, in mancanza, allo Standard Internazionale IEC 60364-7-702:2010.

⚠ **AVVERTENZA** – Accertarsi che l'unità sia collegata esclusivamente a prese di corrente da 230 V_~ dotate di protezione da cortocircuito. La pompa deve essere alimentata da un trasformatore isolato o da interruttore differenziale (RCD) con corrente residua di funzionamento stimata non superiore a 30 mA.

⚠ **AVVERTENZA** – Adottate le dovute precauzioni per evitare che i bambini giochino con l'apparecchio. Evitare di avvicinare le dita e gli oggetti estranei alle aperture e alle parti in movimento.

⚠ **AVVERTENZA** – Il motore deve essere adeguatamente messo a terra. Collegare il filo di messa a terra alla vite di terra verde. In caso di unità collegate con cavo di alimentazione, utilizzare prese opportunamente messe a terra.

⚠ **AVVERTENZA** – Utilizzare l'apposita aletta per connettere il motore alle altre parti collegate, tramite un conduttore di dimensioni appropriate ed in conformità ai codici elettrici.

⚠ **AVVERTENZA** – Effettuare i collegamenti elettrici in base allo schema posto sotto il coperchio della morsettiera del motore. Prima di accendere l'apparecchio, verificare che i collegamenti elettrici siano ben serrati ed ermetici. Prima del funzionamento, rimontare tutti i coperchi.

⚠ **AVVERTENZA** – Accertarsi che la tensione di alimentazione richiesta dal motore corrisponda a quella della rete di distribuzione e che il cavo di alimentazione sia adatto alla potenza e alla corrente della pompa.

⚠ **AVVERTENZA** – Leggere e rispettare tutte le indicazioni contenute nel presente manuale o riportate sull'apparecchio. La mancata osservanza delle suddette istruzioni può causare gravi danni o lesioni. Il presente documento deve essere consegnato al proprietario della piscina e conservato in un luogo sicuro.

⚠ **AVVERTENZA** – L'apparecchio può essere utilizzato solo da bambini di età uguale o superiore agli otto anni o da persone con ridotte capacità fisiche, sensoriali o mentali che abbiano ricevuto istruzioni appropriate e che abbiano compreso i possibili rischi. I bambini non devono giocare con l'apparecchio. L'uso, la pulizia o la manutenzione dell'apparecchio può essere effettuata solo da bambini di età superiore agli otto anni e sotto la supervisione di un adulto. Tenere l'apparecchio e il cavo fuori dalla portata dei bambini di età inferiore agli otto anni.

⚠ **AVVERTENZA** – La pompa è previsto per il funzionamento continuativo alla massima temperatura dell'acqua di 35°C.

⚠ **AVVERTENZA** – Utilizzare esclusivamente parti di ricambio originali Hayward®.

⚠ **AVVERTENZA** – Se il cavo di alimentazione è danneggiato, procedere alla sua sostituzione contattando il produttore, il rappresentante locale o personale qualificato al fine di evitare ogni rischio per la sicurezza.

⚠ **AVVERTENZA** – Per la disconnessione dalla rete di alimentazione, è necessario integrare nei collegamenti elettrici fissi, in conformità con le leggi vigenti, un interruttore esterno con separazione dei contatti su tutti i poli, che garantisca una separazione totale dalla rete in condizioni di sovratensione categoria III.

⚠ **AVVERTENZA** – Non azionare la pompa per piscina in caso di cavo di alimentazione o alloggiamento della scatola di connessione motore danneggiati, che possono dare origine a shock elettrici. Al fine di evitare situazioni di pericolo, il cavo di alimentazione o l'alloggiamento della scatola di connessione motore danneggiati devono essere immediatamente sostituiti dal tecnico dell'assistenza o altro personale qualificato.

⚠ **AVVERTENZA** – Il motore della pompa per piscina NON è dotato di Sistema di Scarico di Sicurezza sotto Vuoto (SVRS). Il sistema SVRS aiuta a evitare il rischio di annegamento rappresentato dagli scarichi sottacqua ai quali si può restare intrappolati. In talune piscine, se una persona blocca lo scarico con il corpo, può restarvi intrappolata dalla forza di aspirazione. A seconda della configurazione della piscina, il montaggio di un sistema SVRS può essere richiesto dalle normative locali

⚠ **AVVERTENZA** – Questa pompa contiene una batteria che, per ragioni di sicurezza, qualsiasi manipolazione deve essere effettuata da un servizio tecnico autorizzato.

UTILIZZARE ESCLUSIVAMENTE PARTI DI RICAMBIO ORIGINALI HAYWARD®

INFORMAZIONI GENERALI

Complimenti per aver acquistato una pompa a velocità variabile Hayward®.

Le pompe a velocità variabile Hayward® possiedono un motore a magnete permanente e commutazione elettronica AC di ultima generazione. Questo motore è comandato da un microprocessore unito a un variatore di frequenza che consente di ottenere le seguenti prestazioni:

- Visualizzazione della velocità di rotazione sul display di controllo
- 3 velocità di rotazione predefinite come impostazioni di fabbrica (pulsanti V1, V2, V3), velocità regolabile dall'utente
- Adescamento sistematico a ogni avvio, velocità e durata dell'adescamento regolabili
- Funzione Skimmer: schiumatura dello specchio d'acqua
- Funzione Timer programmabile
- Visualizzazione della potenza istantanea consumata
- Visualizzazione del consumo energetico totale e parziale
- Visualizzazione del tempo di funzionamento della pompa
- Funzionamento silenzioso
- Standard di fabbricazione TEFC IP55

Installare la pompa a una discreta distanza dalla vasca per ridurre il più possibile il collegamento tra l'aspirazione e la pompa, al fine di limitare inutili ed eccessive perdite di carico nel circuito idraulico.

È, tuttavia, obbligatorio rispettare la distanza di sicurezza richiesta dalle disposizioni di installazione in vigore (ad almeno 3.5 metri dalla vasca). Installare e utilizzare il prodotto ad una altitudine inferiore a 2000 m.

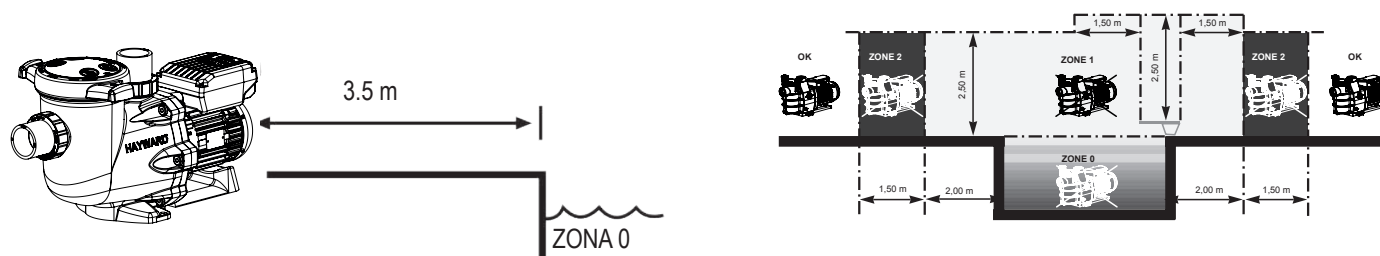

Installare la pompa in un locale ventilato e asciutto, poiché il motore richiede che l'aria circoli liberamente attorno ad essa, per consentirne la ventilazione naturale. Lasciare uno spazio vuoto di almeno 0,5 m tutto intorno alla pompa. Verificare regolarmente che il dispositivo di raffreddamento del motore non sia ostruito da oggetti, foglie o altri ingombri.

La pompa deve essere installata in modo che l'interruttore esterno di scollegamento integrato nella scatola fissa sia visibile e facilmente accessibile. L'interruttore deve essere collocato vicino alla pompa.

La pompa deve essere installata permanentemente su una base in cemento tramite tirafondi di Ø 8 mm adatti al cemento, avvitati agli alloggiamenti dove sono stati praticati fori di installazione. Devono essere previste rondelle di arresto per impedire, nel tempo, l'allentamento dei tirafondi di montaggio. Se la pompa deve essere montata su un piano in legno, devono essere utilizzati viti per legno a testa esagonale di Ø 8 mm adatte al legno e rosette di sicurezza che ne impediscano, nel tempo, l'allentamento.

Installare la pompa in un luogo riparato, al fine di non esporre la scatola di controllo a forti getti d'acqua.

La pressione acustica delle pompe Hayward® è inferiore a 70 dBA.

Istruzioni:

- Collegare la pompa alla messa a terra: Non azionare mai la pompa senza che questa sia messa a terra.
- Collegare la pompa con un cavo di tipo H07RN-F 3G1,5mm².
- Prevedere un dispositivo di protezione differenziale da 30mA per proteggere gli operatori contro il rischio di shock elettrico causato da una possibile rottura del materiale elettrico isolante.
- Prevedere una protezione dai cortocircuiti (la definizione del calibro è in funzione del valore rilevato sulla targa del motore).
- Prevedere un mezzo di scollegamento dalla rete di alimentazione con una distanza di apertura dei contatti di tutti i poli che assicuri un'interruzione completa alle condizioni di categoria di sovratensione III.

⚠ ATTENZIONE: Attendere 5 minuti dopo aver scollegato completamente la pompa dalla rete di alimentazione elettrica prima di intervenire sul motore o sulla scatola di collegamento: **Rischio di shock elettrico letale.**

I motori elettrici delle nostre pompe sono dotati di una protezione termica che reagisce in caso di sovraccarico o riscaldamento anormale dell'avvolgimento del motore. Questa protezione si ricarica automaticamente quando la temperatura dell'avvolgimento si abbassa.

Se richiesto dalla normativa e per qualsiasi tipo di motore utilizzato, è necessario, oltre ai dispositivi sopra elencati, installare una protezione magnetotermica calibrata in base alle indicazioni della targa del motore.

La tabella a pagina 169 riporta le diverse caratteristiche del motore di cui sono dotate le nostre pompe.

UTILIZZARE ESCLUSIVAMENTE PARTI DI RICAMBIO ORIGINALI HAYWARD®

Collegamento elettrico: Assicurarsi che la tensione di alimentazione richiesta dal motore corrisponda a quella della rete di distribuzione e che sezione e lunghezza del cavo di alimentazione siano adatte alla potenza e all'intensità della pompa. I collegamenti elettrici della pompa e l'eventuale sostituzione del cavo di alimentazione devono essere effettuati esclusivamente da un professionista qualificato al fine di evitare rischi e pericoli.

Per effettuare tali collegamenti elettrici rispettare la localizzazione riportata sotto le colonnine di collegamento.

Verificare attentamente il serraggio e la tenuta dei collegamenti elettrici prima di attivarli.

Rispettare il passaggio del cavo attraverso l'orifizio in ferrite previsto; il premistoppa assicura la tenuta intorno al cavo, la ferrite costituisce un filtro per le perturbazioni elettromagnetiche.

L'eventuale precablaggio di cui sono dotate alcune delle nostre pompe deve essere rimosso al momento del collegamento definitivo della pompa alla rete di alimentazione elettrica. Il precablaggio, infatti, è utilizzato solo per i test in fabbrica durante le fasi di produzione.

INSTALLAZIONE

Installare la pompa da piscina limitando al massimo le perdite di carico e rispettando la distanza di sicurezza di almeno 3,5 m tra la pompa e la piscina come precisato nella normativa di installazione. La condotta di aspirazione deve essere installata con una lieve pendenza ascendente verso l'asse della pompa. Assicurarsi che i collegamenti siano ben serrati e stagni. Tuttavia, evitare di bloccare queste tubature in modo esagerato. Per le materie plastiche, assicurare la tenuta esclusivamente con Teflon. Il tubo di aspirazione avrà un diametro uguale o superiore a quello di scarico. Evitare l'installazione in luoghi non ventilati o umidi. Il motore richiede che l'aria di raffreddamento possa circolare liberamente. Installare la pompa in un luogo riparato, al fine di non esporre la scatola di controllo a forti getti d'acqua.

ISTRUZIONI DI AVVIO E DI ADESCAMENTO: Riempire di acqua il corpo del prefiltro fino al livello del tubo di aspirazione. Non azionare mai la pompa senz'acqua, poiché l'acqua è necessaria al raffreddamento e alla lubrificazione dell'otturatore meccanico. Aprire tutte le valvole delle condotte di aspirazione e di scarico, nonché lo scarico d'aria del filtro, se presente. (Tutta l'aria presente nelle condotte di aspirazione dovrà essere eliminata). Avviare il gruppo e attendere un lasso di tempo ragionevole per l'adescamento. Cinque minuti non sono un lasso di tempo esagerato per adescare (tale adescamento dipende dall'altezza di aspirazione e dalla lunghezza del tubo di aspirazione). Se la pompa non si avvia o non adesca, consultare la Guida alla risoluzione dei problemi.

USO DEL COMANDO REMOTO

1. PRESENTAZIONE

La pompa a velocità variabile Hayward® è azionata tramite un comando remoto che permette di visualizzarne e modificarne i parametri di funzionamento e di programmare la modalità Timer.

1	Spia LED di messa in tensione
2	Display LCD
3	Selezione della velocità
4	Passaggio dalla modalità Manuale alla modalità Timer e viceversa
5	Pulsanti di regolazione su/giù
6	Pulsante ON/OFF
7	Pulsante visualizzazione impostazioni
8	Spie LED velocità selezionata

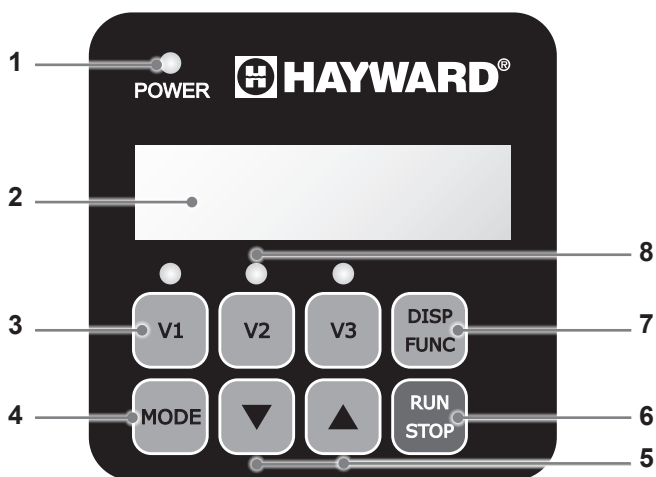

La pompa viene consegnata programmata con **IMPOSTAZIONI PREDEFINITE** (impostazioni di fabbrica):

Adescamento durata (s)	Adescamento velocità (rpm)	V1 (rpm)	V2 (rpm)	V3 (rpm)	Skimmer durata (min.)	Skimmer ciclo (h)	Skimmer velocità (rpm)
240	3000	1500	2400	3000	15	1h	2800

rpm: Giri al minuto

UTILIZZARE ESCLUSIVAMENTE PARTI DI RICAMBIO ORIGINALI HAYWARD®

2. MODALITÀ DI FUNZIONAMENTO DELLA POMPA

2.1 Modalità Manuale

Con la modalità Manuale l'utente avvia o spegne la pompa manualmente a seconda dell'uso che viene fatto della piscina.

- L'avvio della pompa dà automaticamente inizio a una fase di adescamento (a).
Le impostazioni relative a tale fase sono regolabili (velocità e durata, § 4.2). L'adescamento durante la fase di avvio può essere interrotto manualmente (§ 3.2) o disattivato tramite le relative impostazioni.
- In seguito la velocità della pompa si stabilizza su un valore costante (b) (impostazione predefinita: stabilizzazione alla velocità V2). Tale valore può essere selezionato e modificato direttamente dall'utente (§ 3.3).
- In caso di arresto e successivo riavvio, la velocità a cui si stabilizzerà la pompa sarà l'ultima velocità memorizzata.

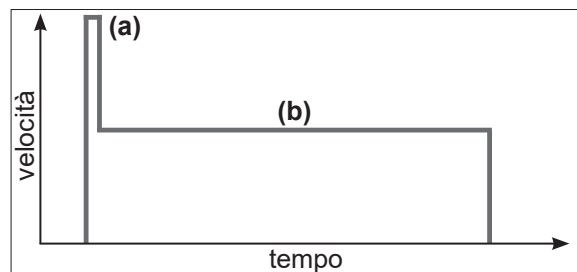

2.2 Skimmer

La funzione Skimmer permette di schiumare lo specchio d'acqua in modo da prevenire l'accumulo e il ristagno di impurità sulla superficie della piscina.

- La funzione Skimmer è automatica: la pompa funziona a una velocità maggiore (c) per un intervallo di tempo e un ciclo regolabili.
- Al termine del ciclo predefinito la pompa riprende a funzionare a velocità normale a prescindere dal fatto che sia attiva la modalità Manuale oppure quella Timer.
- La funzione Skimmer può essere disattivata (v. impostazioni § 4.3).

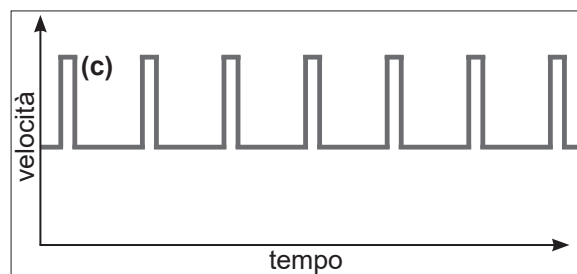

2.3 Modalità Timer

Con la modalità Timer il funzionamento della pompa è completamente automatizzato 24 ore su 24. Il modo in cui devono susseguirsi le varie velocità (d) deve essere impostato dall'utente. Tale impostazione sarà definita tenendo conto del tipo di impianto (modalità di riscaldamento, economizzatore di energia, ecc.) e degli orari in cui la piscina è utilizzata.

- Se la funzione Skimmer è attivata, essa va a sovrapporsi alle sequenze di velocità impostate.
- In Modalità Timer è possibile arrestare (mettere in stand-by) la pompa. Quando sarà riavviata la velocità adottata sarà quella del Timer in esecuzione.
- Per impostare la modalità Timer fare riferimento al § 4.5.

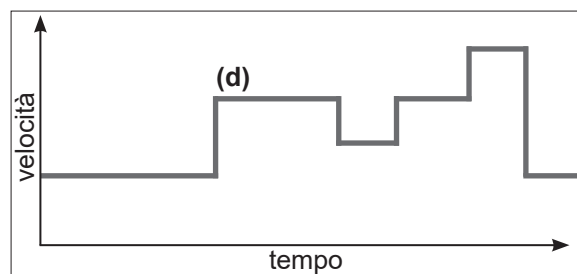

2.4 Passare dalla modalità Manuale alla modalità Timer e viceversa

Per passare da una modalità all'altra è sufficiente premere il pulsante **MODE** come indicato nella figura seguente:

Modalità Manuale

Visualizzazione della velocità senza prefisso

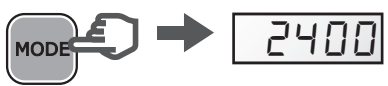

Il LED acceso indica la velocità selezionata (velocità predefinita = V2)



Modalità Timer

Visualizzazione della velocità con prefisso "t"

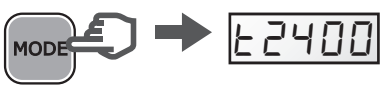

I LED sono spenti



UTILIZZARE ESCLUSIVAMENTE PARTI DI RICAMBIO ORIGINALI HAYWARD®

2.5 Collegamento degli ingressi digitali esterni

⚠ ATTENZIONE: Prima di eseguire eventuali interventi di natura elettrica scollegare la pompa dalla rete di alimentazione e attendere 5 min.

La pompa di filtraggio è dotata di un cavo a 5 fili di 3 m di lunghezza che consente di collegare 4 ingressi digitali o contatti puliti liberi da potenziale (Aperto/Chiuso).

Esempi di utilizzo degli ingressi digitali

- Assegnare la velocità e la portata necessarie per garantire il corretto funzionamento di organi periferici come pompa di calore, tapparelle, robot ad aspirazione, ecc.
- Installare un richiamo di comando dell'interfaccia utente. Gli ingressi digitali consentiranno di comandare la funzione Run/Stop e le 3 velocità (V1-V2-V3) fino a una distanza di 3 m.

Assegnazione dei fili		
DI1	Marrone	Velocità V1
DI2	Verde	Velocità V2
DI3	Bianco	Velocità V3
DI4	Rosso	Run/Stop
C	Nero	Comune

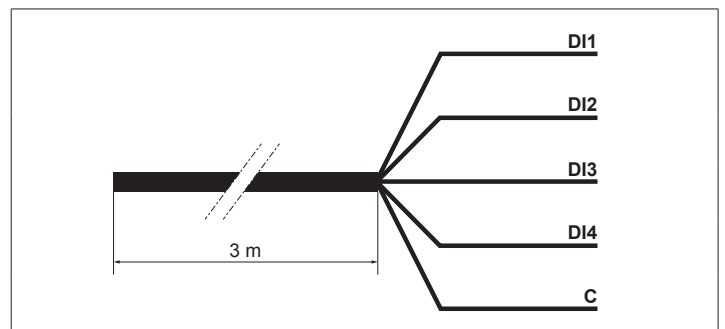

N.B.:

- Nel caso in cui non vengano impiegati tutti gli ingressi digitali isolare elettricamente i fili inutilizzati.
- Nel caso in cui gli ingressi digitali non vengano utilizzati, al posto del cavo a 5 fili inserire il connettore (A) (v. figura seguente).

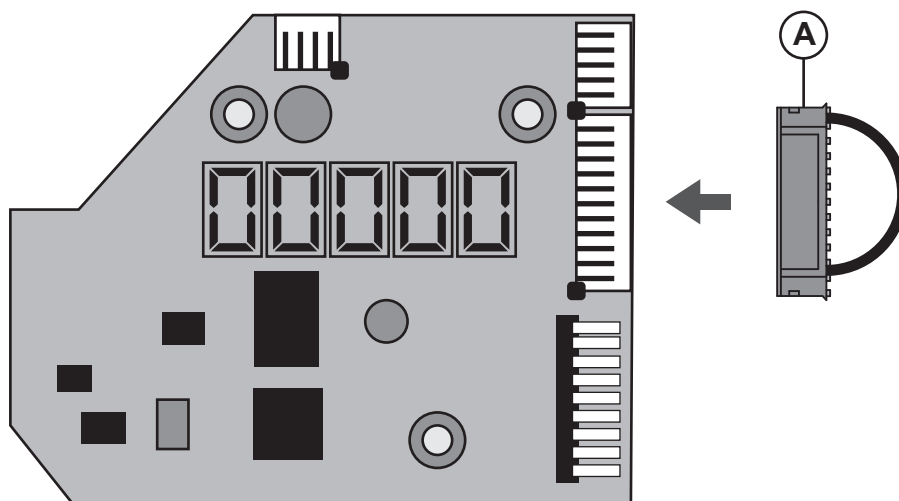

UTILIZZARE ESCLUSIVAMENTE PARTI DI RICAMBIO ORIGINALI HAYWARD®

Funzionamento con gli ingressi digitali

<p>Gli ingressi digitali possono essere utilizzati sia in Modalità Manuale che in Modalità Timer.</p> <p>Gli ingressi digitali hanno priorità massima: sono MASTER rispetto a tutte le funzioni in fase di utilizzo.</p> <p>Solo i pulsanti Run/Stop e DISP/FUNC rimangono attivi.</p>	→	
	→	
<p>Quando un ingresso digitale è in uso il LED collegato alla velocità interessata lampeggia rapidamente (DI1 = V1, DI2 = V2 o DI3 = V3).</p>	→	

<p>Per fare in modo di ottenere un'azione attraverso gli ingressi digitali l'ingresso DI4 deve essere chiuso.</p>	→	DI4 Run/StopChiuso		
<p>Se si commutano contemporaneamente più ingressi digitali sarà commutato un solo ingresso alla volta in base all'ordine di priorità definito nella tabella seguente.</p>		DI1 = V1	DI2 = V2	DI3 = V3
	DI1 = V1	V1	V2	V3
	DI2 = V2	V2	V2	V3
	DI3 = V3	V3	V2	V3

N.B.: Quando l'azione associata all'ingresso digitale è eseguita (contatto aperto), la pompa di filtraggio torna a funzionare secondo la modalità attiva.

<p>Se l'ingresso digitale DI4 è aperto, la pompa di filtraggio non parte e sul suo display compare il messaggio dSTOP.</p> <ul style="list-style-type: none"> • Chiudere l'ingresso DI4. • Se necessario, premere RUN/STOP per avviare la pompa di filtraggio. 	→	
	→	
	→	

3. USO

3.1 Messa in tensione







La spia "Power" si accende; il display esegue un test LCD, quindi viene visualizzata la versione del software

→



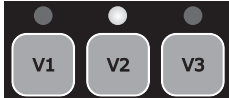



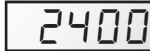
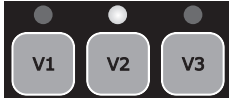

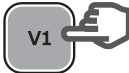

→

3.2 Fase di adescamento

La fase di adescamento si avvia automaticamente in seguito alla messa in tensione della pompa (o in seguito a un riavvio della stessa).







<p>Avvio automatico della fase di adescamento:</p> <ul style="list-style-type: none"> La velocità aumenta fino a 3000 rpm e viene mantenuta costante per 240 s (valori predefiniti) 		→		
<p>Termine della fase di adescamento:</p> <ul style="list-style-type: none"> La velocità si stabilizza su V2 (impostazione predefinita) o sull'ultima velocità memorizzata Il LED corrispondente si accende (modalità Manuale) 		→		
<p>Visualizzare la durata residua dell'adescamento:</p> <ul style="list-style-type: none"> Premere DISP/FUNC La durata residua viene visualizzata (espressa in s) 		→		
<p>Interrompere l'adescamento prima del termine dell'intervallo di tempo predefinito:</p> <ul style="list-style-type: none"> Premere RUN/STOP La velocità si stabilizza su V2 (impostazione predefinita) o sull'ultima velocità memorizzata 		→		

3.3 Selezione, impostazione e memorizzazione di una velocità in modalità Manuale

<p>Selezionare una velocità:</p> <ul style="list-style-type: none"> Premere uno dei pulsanti velocità Viene visualizzato il valore predefinito (in rpm) Il LED corrispondente si accende 		→		
<p>Modificare il valore relativo alla velocità:</p> <ul style="list-style-type: none"> Premere i pulsanti di regolazione su/giù Il LED lampeggia: impostazione in corso Impostare il valore desiderato (da 600 a 3000 rpm) 	 	→		
<p>Salvare il nuovo valore relativo alla velocità:</p> <ul style="list-style-type: none"> Premere e tenere premuto per 3 s il pulsante velocità Quando la velocità è memorizzata il LED diventa acceso fisso 		→		

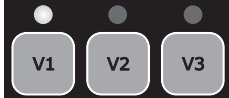
N.B.: La portata d'acqua generata dalla velocità della pompa deve essere adeguata alla capacità dell'impianto (filtro, canalizzazioni, ecc.). In caso di dubbi si consiglia di rivolgersi a un professionista.

3.4 Arresto/riavvio della pompa

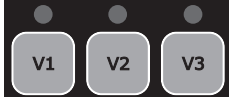













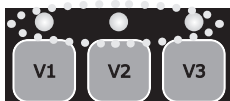

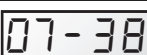
<p>Arrestare la pompa:</p> <ul style="list-style-type: none"> Premere RUN/STOP La pompa si arresta, il LED velocità rimane acceso In modalità Manuale sul display viene visualizzata la scritta "StoP" fissa (lampeggiante in modalità Timer) 		→		
<p>Riavviare la pompa:</p> <ul style="list-style-type: none"> Premere RUN/STOP La pompa si avvia con la fase di adescamento (§ 3.2) La velocità si stabilizza: sull'ultimo valore memorizzato, se in modalità Manuale, o sulla velocità definita in base al Timer in esecuzione, se in modalità Timer 		→		
		→		

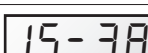
UTILIZZARE ESCLUSIVAMENTE PARTI DI RICAMBIO ORIGINALI HAYWARD®

4. IMPOSTAZIONI



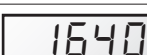

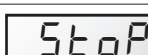







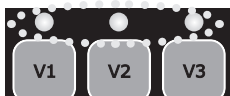

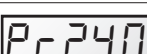





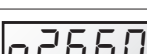

N.B.: Per poter accedere alle impostazioni la pompa deve essere in tensione, in **modalità Manuale** (§ 2.4) e non essere in fase di adescamento; è invece indifferente che sia ferma o in funzione.
 Se per 2 min. non viene premuto nessun pulsante la visualizzazione torna a essere quella normale (velocità o StoP) e le eventuali impostazioni modificate non vengono salvate.

4.1 Impostazione dell'orologio

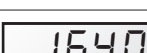
<ul style="list-style-type: none"> • Premere e tenere premuto per 3 s DISP/FUNC I 3 LED lampeggiano • Sul display compare la scritta "ConF" e quindi la scritta "hr" 						
<ul style="list-style-type: none"> • Premere DISP/FUNC, sul display viene visualizzata l'ora dell'orologio interno (hh-min) 						
<ul style="list-style-type: none"> • Per impostare le ore e i minuti premere i pulsanti di regolazione su/giù 						
<ul style="list-style-type: none"> • Premere RUN/STOP per uscire e salvare Sul display viene visualizzata la velocità attuale oppure la scritta StoP 						

N.B.: Se la pompa funziona in modalità **Timer** la **corretta impostazione dell'orologio interno è di fondamentale importanza.**
 L'ora resta memorizzata anche quando la pompa è messa fuori tensione.

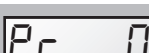
4.2 Configurazione dell'adescamento

<ul style="list-style-type: none"> • Premere e tenere premuto per 3 s DISP/FUNC I 3 LED lampeggiano e sul display viene visualizzata la scritta "ConF" 					
<ul style="list-style-type: none"> • Premere più volte DISP/FUNC finché sul display non compare la scritta "Pr 240", che corrisponde alla durata dell'adescamento predefinita (s) 					
<ul style="list-style-type: none"> • Premere i pulsanti di regolazione su/giù per visualizzare l'intervallo di tempo desiderato (da 0 s a 300 s) 					
<ul style="list-style-type: none"> • Premere DISP/FUNC: sul display compare la scritta "o3000", che equivale alla velocità di adescamento predefinita (rpm) 					
<ul style="list-style-type: none"> • Premere i pulsanti di regolazione su/giù per visualizzare il valore desiderato (max. 3000 rpm) 					
<ul style="list-style-type: none"> • Premere RUN/STOP per uscire e salvare Sul display viene visualizzata la velocità attuale oppure la scritta StoP 					
<p>N.B.: Se la durata di adescamento è impostata su 0 sul display viene visualizzata la scritta "ProFF": in tal caso l'adescamento è disattivato</p>					

4.3 Configurazione della funzione Skimmer

Per la descrizione della funzione fare riferimento al § 2.2

<ul style="list-style-type: none"> • Premere e tenere premuto per 3 s DISP/FUNC I 3 LED lampeggiano e sul display viene visualizzata la scritta "ConF" 		→	ConF	
<ul style="list-style-type: none"> • Premere più volte DISP/FUNC finché sul display non compare la scritta "SFO.15" : durata di attivazione della funzione Skimer predefinita (in minuti) 		→	SFO.15	
<ul style="list-style-type: none"> • Premere i pulsanti di regolazione su/giù per visualizzare l'intervallo di tempo desiderato (da 0 a 30 min.) 		→	SFO20	
<ul style="list-style-type: none"> • Premere DISP/FUNC: sul display compare la scritta "St 1h", che equivale alla durata predefinita del ciclo Skimmer 		→	St 1h	
<ul style="list-style-type: none"> • Premere i pulsanti di regolazione per impostare il ciclo Skimmer su 1 h, 2 h o 3 h 		→	St 2h	
<ul style="list-style-type: none"> • Premere DISP/FUNC: sul display compare la scritta "S2800", che equivale alla velocità predefinita dello Skimmer (rpm) 		→	S2800	
<ul style="list-style-type: none"> • Premere i pulsanti di regolazione su/giù per visualizzare la velocità desiderata (da 600 a 3000 rpm) 		→	S2680	
<ul style="list-style-type: none"> • Premere RUN/STOP per uscire e salvare Sul display viene visualizzata la velocità attuale oppure la scritta StoP 		→	1640 / StoP	
N.B.: Per disattivare la funzione Skimmer, impostare la durata su 0: sul display compare la scritta "SFoFF"		→	SFoFF	

4.4 Reset impostazioni

Per ripristinare le impostazioni predefinite e cancellare le modifiche in modalità Timer, procedere come segue:

<ul style="list-style-type: none"> • Premere e tenere premuto per 3 s DISP/FUNC I 3 LED lampeggiano e sul display viene visualizzata la scritta "ConF" 		→	ConF	
<ul style="list-style-type: none"> • Premere più volte DISP/FUNC finché sul display non compare la scritta "Init" 		→	Init	
<ul style="list-style-type: none"> • Premere e tenere premuto il pulsante di regolazione "su" per 3 s. Una volta eseguito il reset, sul display compare la scritta "donE" 		→	donE	→ StoP

Promemoria: impostazioni predefinite e range di regolazione

	Adescamento		Pulsanti velocità			Funzione Skimmer			Funzione Timer			
	P _r	o ₋₋₋	V1	V2	V3	SF	St	S ₋₋₋	t0	rpm	t1 - t5	rpm
Unità	s	rpm	rpm	rpm	rpm	min	h	rpm	hh-min	rpm	hh-min	rpm
Predefinito	240	3000	1500	2400	3000	15	1	2800	06-00	2400	oFF	0
Mini	0 (oFF)	600	600	600	600	0 (oFF)	1 ...	600	00-00	—	00-00	0/ 600
Maxi	300	3000	3000	3000	3000	30	... 3	3000	24-00	—	24-00	3000

UTILIZZARE ESCLUSIVAMENTE PARTI DI RICAMBIO ORIGINALI HAYWARD®

4.5 Programmazione della modalità Timer

Il comando remoto consente di programmare varie sequenze (v. § 2.3) o Timer, da t0 a t5, che non devono necessariamente essere disposte in ordine cronologico.

I Timer non utilizzati saranno disattivati.

Il Timer "t0" può essere impostato su 00:00, 06:00 (impostazione predefinita), 12:00 o 18:00. Il Timer "t0" non può essere disattivato.

La velocità del segmento t0 non è modificabile ed è fissata a 2400 rpm

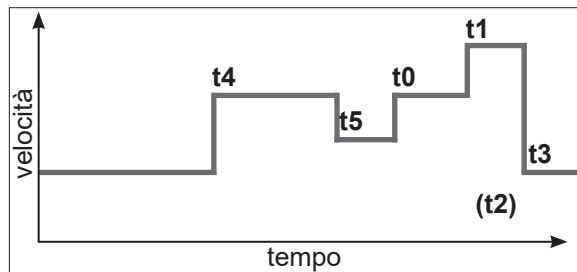



















- Tracciare la sequenza di velocità che si desidera programmare. Il grafico a lato è fornito a titolo esemplificativo.
- Controllare che l'orologio interno sia impostato correttamente.

<ul style="list-style-type: none"> • Premere e tenere premuto per 3 s DISP/FUNC. I 3 LED lampeggiano e sul display viene visualizzata la scritta "ConF" 				
<ul style="list-style-type: none"> • Premere 2 volte DISP/FUNC finché sul display non compare la scritta "t0" 				
<ul style="list-style-type: none"> • Premere DISP/FUNC: sul display compare la scritta "06-00", che equivale al valore predefinito di t0 				
<ul style="list-style-type: none"> • Premere i pulsanti di regolazione per impostare il t0 desiderato (00-00, 06-00, 12-00 o 18-00) 				
<ul style="list-style-type: none"> • Premere DISP/FUNC: sul display compare la scritta "t1oFF" 				
<ul style="list-style-type: none"> • Per attivare il Timer (il Timer dell'esempio) premere il pulsante "su". Sul display compare la scritta "t1 on" 				
<ul style="list-style-type: none"> • Premere DISP/FUNC: sul display compare la scritta "00-00" 				
<ul style="list-style-type: none"> • Premere i pulsanti di regolazione su/giù per impostare l'orario desiderato (hh-mm) 				
<ul style="list-style-type: none"> • Premere DISP/FUNC: sul display compare la scritta "0" 				
<ul style="list-style-type: none"> • Premere i pulsanti di regolazione per visualizzare la velocità desiderata (da 600 a 3000 rpm oppure 0) 				
<ul style="list-style-type: none"> • Premere DISP/FUNC per passare al Timer successivo: sul display compare la scritta "t2off". Nell'esempio fornito questo Timer rimane disattivato 				
<ul style="list-style-type: none"> • Premere DISP/FUNC per passare al Timer successivo e ripetere le operazioni di cui sopra per le varie fasi di impostazione (attivazione, orario Timer e velocità) 				
<ul style="list-style-type: none"> • Premere RUN/STOP per uscire e salvare. Sul display viene visualizzata la velocità attuale oppure la scritta StoP 				

UTILIZZARE ESCLUSIVAMENTE PARTI DI RICAMBIO ORIGINALI HAYWARD®

5. VISUALIZZAZIONE DELLE IMPOSTAZIONI

N.B.: La pompa deve essere in tensione e non essere in fase di adescamento; è invece indifferente che sia ferma o in funzione. Per scorrere tra le varie impostazioni premere DISP/FUNC.
Se per 15 s non viene premuto nessun tasto il display torna alla visualizzazione normale (velocità attuale o Stop).

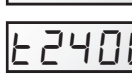
<ul style="list-style-type: none"> Premere DISP/FUNC: sul display compare la scritta "hr". Premere nuovamente DISP/FUNC: sul display viene visualizzata l'ora interna 	 → hr	 → 11-45
<ul style="list-style-type: none"> Premere DISP/FUNC: sul display compare la scritta "t0". Premere nuovamente DISP/FUNC: sul display viene visualizzato l'orario di t0 (la velocità del t0 è fissa ed è di 2400 rpm) 	 → t0	 → 12-00
<ul style="list-style-type: none"> Premere DISP/FUNC: sul display compare la scritta "t1". Premere nuovamente DISP/FUNC: sul display viene visualizzato l'orario del Timer (hh-mm) 	 → t1	 → 09-20
<ul style="list-style-type: none"> Premere DISP/FUNC: visualizzazione della velocità del Timer (in rpm) 	 → 1240	
<ul style="list-style-type: none"> Premere DISP/FUNC ecc.: visualizzazione dei Timer successivi, compresi orario e velocità, fino al Timer "t5" <p>N.B.: I Timer disattivati non vengono visualizzati</p>	 → t2	ecc.
<ul style="list-style-type: none"> Premere DISP/FUNC: sul display viene visualizzata la scritta "P - - - -" <p>Potenza consumata (in W, valore a +/- 10%)</p> <p>N.B.: P = 0 W quando la pompa è ferma</p>	 → P 634 / P 0	
<ul style="list-style-type: none"> Premere DISP/FUNC: sul display viene visualizzata la scritta "h - - - -" <p>Contatore orario della pompa</p> <p>N.B.: Un giro del contatore equivale a 9999 h</p>	 → h2857	
<ul style="list-style-type: none"> Premere DISP/FUNC: sul display viene visualizzata la scritta "- - - - -" <p>Consumo di energia totale (in kWh)</p> <p>N.B.: Un giro del contatore equivale a 99999 kWh</p>	 → 06542	
<ul style="list-style-type: none"> Premere DISP/FUNC: sul display viene visualizzata la scritta "- - - - -" <p>Consumo di energia parziale (in kWh) dall'ultimo azzeramento</p>	 → 00086	
<ul style="list-style-type: none"> Azzerare il contatore di energia parziale: Premere e tenere premuto per 3 s il pulsante "su" o il pulsante "giù". Sul display compare la scritta "CLEAR": il contatore parziale è stato azzerato 	   >3s → CLEAR	
<ul style="list-style-type: none"> Premere DISP/FUNC: Visualizzazione "SF On" o "SFOFF" per Skimmer attivato o disattivato 	 → SF On / SFOFF	
<ul style="list-style-type: none"> Premere DISP/FUNC: Visualizzazione "t - -" <p>Temperatura del modulo di potenza (in °C)</p>	 → t 74	
<ul style="list-style-type: none"> Premere DISP/FUNC per tornare alla visualizzazione normale (velocità attuale o Stop) 	 → 1640 / Stop	 → t2400 / Stop

UTILIZZARE ESCLUSIVAMENTE PARTI DI RICAMBIO ORIGINALI HAYWARD®

MANUTENZIONE

1. Scollegare completamente la pompa dalla rete di alimentazione prima di aprire il coperchio e pulire il prefiltro. Pulire regolarmente il cesto del prefiltro, facendo attenzione a non urtare il cesto. Controllare la guarnizione del coperchio del prefiltro e sostituirla se necessario.
2. L'asse del motore è montato su cuscinetti autolubrificanti che non necessitano di ulteriore lubrificazione.
3. Tenere il motore pulito e asciutto e assicurarsi che gli orifici di ventilazione non siano ostruiti.
4. Occasionalmente si può verificare una fuga nella tenuta meccanica,, che dovrà essere sostituito.
5. Ad eccezione della pulizia della piscina, tutte le operazioni di riparazione, cura o manutenzione devono essere effettuate esclusivamente da un agente autorizzato Hayward® o da personale qualificato.

Le parti soggette ad usura della pompa menzionate di seguito devono essere sottoposte a manutenzione in base alla loro durata stimata:

Durata stimata delle parti usurate:

Tenuta meccanica	1 anno
Kit cuscinetti motore	1 anno
Kit guarnizioni (prefiltro, corpo, raccordi, scarico)	2 anni
Condensatore	2 anni

STOCCAGGIO

1. Svuotare la pompa rimuovendo tutti i tappi di svuotamento e conservandoli nel cesto del prefiltro.
2. Scollegare la pompa, rimuovere i raccordi delle tubature e conservare il gruppo completo in un luogo asciutto e aerato o adottare la seguente precauzione: scollegare la pompa, rimuovere i 4 bulloni di fissaggio del corpo della pompa al supporto del motore e conservare il tutto in un luogo asciutto e aerato. Proteggere il corpo della pompa e del prefiltro

NOTA: Prima di rimettere in uso la pompa, pulire tutte le parti interne rimuovendo polvere, incrostazioni, ecc.

GUIDA ALLA RISOLUZIONE DEI PROBLEMI

A) Il motore non si avvia

1. Verificare i collegamenti elettrici, gli interruttori o relè e gli interruttori di corrente o fusibili.
2. Assicurarsi manualmente della libera rotazione del motore.
3. Verificare che le velocità di rotazione V1 V2 e V3 non siano programmate a 0 g/min. Se il caso lo richiede, procedere a una reinizializzazione dei parametri di fabbrica (v. § 4.4).
4. Se sul display compare uno dei seguenti codici di errore contattare l'installatore:

Err01	Sottotensione linea corrente continua	Err10	Problema alimentazione elettrica interna
Err02	Sovratensione linea corrente continua	Err20	Avvio non riuscito
Err04	Surriscaldamento modulo di potenza	Err64	Problema cortocircuito interno
Err05	Surriscaldamento motore	Err97	Problemi multipli
Err07	Sovrintensità	Err98	Problema di comunicazione
		dStop	Vedere a pagina 90

B) Il motore si arresta, verificare

1. Cavi, collegamenti, relè, ecc.
2. La caduta di tensione del motore (spesso causata da cavi troppo deboli).
3. Che non si sia verificato alcun inceppamento o sovraccarico (attraverso la lettura dell'ampere assorbito).

NOTA: Il motore della pompa è dotato di una protezione termica che, in caso di sovraccarico, interromperà automaticamente il circuito, evitando che il motore si deteriori. Tale disinnesto è causato da condizioni anormali di utilizzo che è necessario verificare e correggere. Il motore si riavvierà senza alcun intervento dal momento in cui le normali condizioni di funzionamento saranno ripristinate.

C) «OLOAD» si visualizza sul display (problema di sovraccarico o surriscaldamento)

1. Verificare che l'albero motore giri liberamente
2. Verificare che nessun detrito ingombri la libera rotazione della turbina
3. Verificare che il motore sia correttamente ventilato
4. Dopo aver risolto il problema premere il pulsante ON/OFF

D) La pompa non adescia

UTILIZZARE ESCLUSIVAMENTE PARTI DI RICAMBIO ORIGINALI HAYWARD®

1. Assicurarsi che il corpo del prefiltro sia ben riempito d'acqua, che la guarnizione del coperchio sia pulita e ben posizionata e che non sia possibile alcun ingresso di aria. Se necessario, stringere di nuovo le viti di bloccaggio del coperchio.
2. Assicurarsi che tutte le valvole di aspirazione e di scarico siano aperte e non ostruite, e che tutte le bocche di aspirazione della piscina siano completamente immerse.
3. Verificare se la pompa aspira innescando l'aspirazione il più vicino possibile alla pompa stessa:
 - a) se la pompa non aspira nonostante un riempimento sufficiente in termini di acqua di adescamento
 1. Stringere di nuovo la bulloneria della tubatura del lato di aspirazione.
 2. Verificare la tensione per assicurarsi che la pompa giri alla velocità adeguata.
 3. Aprire la pompa e verificare che non ci sia nulla che ne ostruisca l'interno.
 4. Impostare una velocità di adescamento sufficiente
 5. Pulire il filtro, quindi riprovare
 6. Sostituire l'otturatore meccanico.
 - b) Tentare di effettuare un adescamento in modalità ricircolo. Se la pompa aspira normalmente, verificare la condotta di aspirazione e il prefiltro che potrebbero essere ostruiti o causare l'ingresso di aria.

E) Pompa rumorosa, verificare

1. Se l'ingresso o la presenza di aria in aspirazione provoca scoppiettii sordi nella pompa.
2. Se non è evidente alcuna cavitazione causata da un diametro insufficiente o da un restringimento della condotta di aspirazione. Allo stesso modo, una condotta sovradimensionata in fase di scarico può causare tale cavitazione. Utilizzare tubature adeguate o drenare le condotte, se necessario.
3. Se si percepiscono vibrazioni causate da un montaggio scorretto.
4. Se un corpo estraneo si trova nel corpo della pompa.
5. Se i cuscinetti del motore sono inceppati a causa di un gioco troppo elevato, della ruggine o di un surriscaldamento prolungato.



HAYWARD®

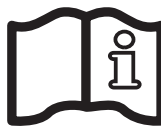
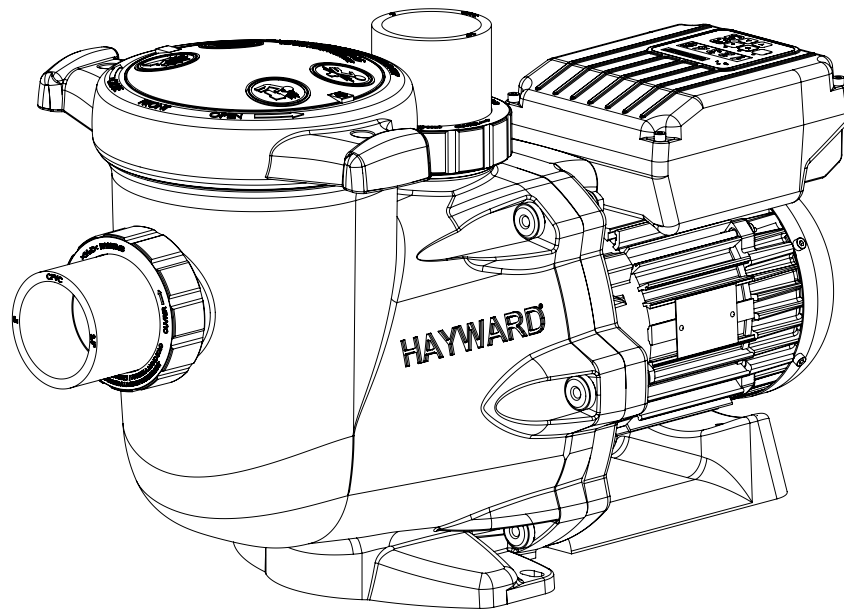

CENTRIFUGALPUMP MED VARIABELT VARVTAL

ANVÄNDARHANDLEDNING

SPARA DENNA HANDLEDNING FÖR SENARE REFERENS



VARNING: Elektrisk fara. Underlåtenhet att följa instruktionerna kan leda till allvarliga skador eller dödsfall.

FÖR ANVÄNDNING I SIMPASSER

⚠ VARNING – Innan du öppnar locket för filterrengöring, koppla bort pumpen helt från elnätet.

⚠ VARNING – Alla elektriska anslutningar måste göras av en kvalificerad auktoriserad professionell elektriker och i enlighet med gällande bestämmelser i installationslandet, om inte detta, den internationella standarden IEC 60364-7-702.

⚠ VARNING – Se till att maskinen endast är ansluten till ett 230 V_~-uttag skyddat mot kortslutning. Pumpen ska drivas med hjälp av en isolerande transformator eller via en jordfelsbrytare (RCD) med en nominell restström som inte överstiger 30mA.

⚠ VARNING – Se till att barn inte leker med denna apparat. Håll fingrar och främmande föremål borta från öppningar och rörliga delar.

⚠ VARNING – Motorn måste placeras korrekt på marken. Anslut jordledningen till den gröna skruven på basen och för fasta enheter använd rätt jorduttag.

⚠ VARNING – Använd en motoranslutningssko för att ansluta motorn till andra anslutningsdelar med rätt storlek på ledaren som specificeras i elektriska koder.

⚠ VARNING – När du gör sådana elektriska anslutningar, gå igenom diagrammet under motoranslutningsboxens lock. Se till att kontrollera att de elektriska anslutningarna är täta och täta innan du ansluter till ström. Ta bort alla höljen före användning.

⚠ VARNING – Se till att den elektriska matningsspänningen som krävs av motorn överensstämmer med den för distributionsnätet och att de elektriska matningskablarna motsvarar pumpens effekt och ström.

⚠ VARNING – Läs och följ alla instruktioner som finns i denna bruksanvisning och märkta på utrustningen. Underlåtenhet att följa instruktionerna kan orsaka kroppsskada.

Detta dokument ska lämnas till poolägaren som ska förvara det på en säker plats.

⚠ VARNING – Barn över 8 år och personer utan nödvändig kunskap eller erfarenhet eller med fysiska, psykiska eller sensoriska funktionshinder kan använda denna apparat om de har fått lämpliga instruktioner och förstår farorna med att använda den. Barn får inte leka med apparaten. Rengöring och användarunderhåll får inte utföras av barn, såvida de inte är över 8 år och övervakade. Förvara apparaten och kabeln utom räckhåll för barn under 8 år.

⚠ VARNING – Pumpen är konstruerad för kontinuerlig drift vid en maximal vattentemperatur på 35°C.

⚠ VARNING – Använd endast äkta Hayward® reservdelar.

⚠ VARNING – Om nätsladden är skadad måste den bytas ut av tillverkaren, dess återförsäljare eller liknande kvalificerade personer för att undvika faror.

⚠ VARNING – En extern brytare med allpolig kontaktseparation som ger fullständig fränkoppling under kategori III överspänningsförhållanden måste installeras i fast ledning som överensstämmer med ledningsreglerna för fränkoppling från strömförsörjningen.

⚠ VARNING – Använd inte poolpumpen om anslutningskabeln eller motoranslutningsboxens hölje är skadat. Detta kan orsaka en elektrisk stöt. En skadad strömkabel eller motoranslutningsdosa måste omedelbart bytas ut av en tekniker eller liknande kvalificerad person för att undvika fara.

⚠ VARNING – Denna poolmotor är INTE utrustad med ett säkerhetsvakuumlösningssystem (SSLV). SSLV hjälper till att förhindra drunkning från kroppsfångning i nedsänkta avlopp. I vissa poolkonfigurationer, om en persons kropp täcker avloppet, kan personen fastna av sug. Beroende på din poolkonfiguration kan en SSLV krävas för att uppfylla lokala krav.

⚠ VARNING – Denna pump innehåller ett batteri som, av säkerhetsskäl, all manipulation måste utföras av en kvalificerad teknisk service.

ANVÄND ENDAST HAYWARD® ORIGINAL RESERVDLAR

ALLMÄNT

Grattis, du har just köpt en Hayward® pump med variabelt varvtal.

Pumpar med variabelt varvtal från Hayward® har en permanentmagnetmotor med elektronisk växelströmsomkastare av senaste generationen. Motorn styrs av en mikroprocessor som är kopplad till en frekvensvariator som ger följande egenskaper:

- Visar rotationshastigheten på kontrollskärmen
- 3 fabriksinställda, fördefinierade hastigheter (knappar V1, V2, V3). Hastigheten kan ställas in av användaren
- Systematisk initiering vid uppstart, justerbar hastighet och längd på initiering
- Skimmer-funktion, tar bort skummet från vattenytan
- Programmerbar timer-funktion
- Visning av omedelbar effektförbrukning
- Visning av total och partiell energiförbrukning
- Visning av pumpens funktionstid
- Låg ljudnivå
- Konstruktionsnorm TEFC IP55

Installera pumpen på rätt avstånd från bassängen så att förbindelsen mellan utsug och pump blir så kort som möjligt. Detta för att begränsa onödiga och alltför kraftiga tryckfall över vattenkretsen.

Man måste emellertid respektera det säkerhetsavstånd som krävs enligt gällande installationsstandard (minst 3.5 meter). Installera och använd produkten på en höjd mindre än 2000m.

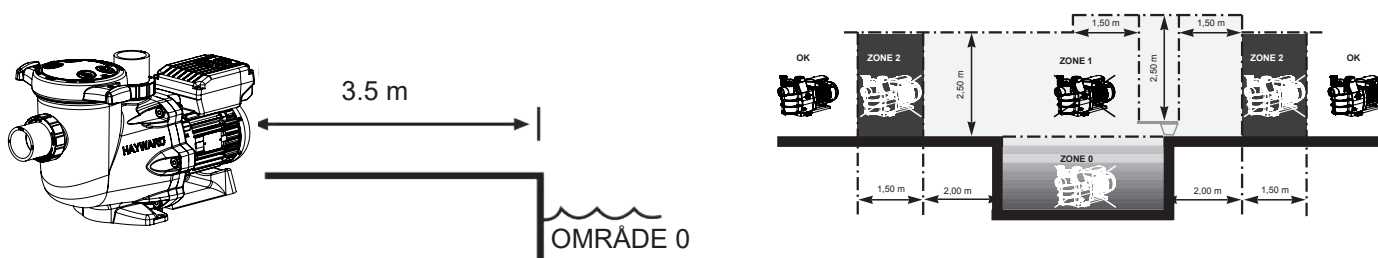

Installera pumpen i ett torrt utrymme med god luftväxling. Tillhandahålla ett minsta avstånd på 0,5 m runt pumpen. Motorns naturliga kylning kräver att luften runt den kan cirkulera fritt. Kontrollera regelbundet att inga föremål, löv eller annat blockerar motorkylningen.

Pumpen ska vara installerad så att den externa strömbrytaren som sitter i den fasta boxen syns och är lätt åtkomlig. Brytaren ska sitta nära pumpen.

Pumpen ska vara permanent installerad på ett betongfundament med hjälp av \varnothing 8 mm vagnsbultar för betong som skruvas fast på de ställen där fixeringshål förberetts. Låsbrickor ska användas för att hindra att montagets vagnsbultar skruvar loss sig med tiden. Ska pumpen monteras på en träplanka ska \varnothing 8 mm träskruv med sexkantigt huvud användas jämte låsbrickor för att hindra att skruvarna lossnar med tiden.

Installera pumpen under ett skydd så att manöverboxen inte utsätts för kraftiga vattenstänk.

Ljudtrycket från Hayward® pumpar är lägre än 70 dBA.

Anordningar som krävs:

- Anslut pumpen till jord: använd aldrig pumpen utan att den är jordad.
- Anslut pumpen med en kabel av typ H07RN-F 3G1,5mm².
- Anslut en anordning med ett 30 mA differentialskydd för att skydda personer från elstötar orsakade av att utrustningens elektriska isolering skadats.
- Installera ett skydd mot kortslutningar (kaliber fastställs utifrån det värde som står på pumpens märkplåt).
- Installera en frånskiljare för elmatningen med ett öppningsavstånd för kontaktorna till samtliga poler som medger fullständig frånskiljning under förhållanden för överspänning av kategori III.

⚠ VIKTIGT: vänta fem minuter efter att helt ha frånkopplat pumpen från elmatningen innan du utför åtgärder på motor eller kopplingsdosa: **risk för elstöt som kan leda till döden.**

De elmotorer som sitter i våra pumpar har motorskydd som reagerar vid överbelastning eller onormal överhettning av motorns lindning. Skyddet återställs automatiskt när lindningens temperatur sjunker.

Om så krävs enligt bestämmelserna och oavsett vilken motor som används, måste man utöver ovan angivna anordningar installera ett magnetiskt/termiskt skydd som ska vara kalibrerat enligt anvisningarna på motorns märkplåt.

I tabellen på sidan 169 anges egenskaperna för de motorer som sitter i våra pumpar.

ANVÄND ENDAST HAYWARD® ORIGINAL RESERVDLAR

Elanslutning: kontrollera att den matningsspänning motorn kräver överensstämmer med lokal nätspänning och att kabelns tvärsnitt och längd är lämpade för pumpens effekt och strömstyrka. För att undvika eventuell risk ska samtliga elanslutningar till pumpen och eventuellt byte av nätsladd utföras av kvalificerad personal. Respektera vid elanslutningen den märkning som är graverad över anslutningsplintarna. Kontrollera före strömsättning att elanslutningarna är åtdragna och täta.

Var noga med att dra kabeln genom den särskilda öppningen och ferriten. Packboxen garanterar att det är tätt runt kabeln och ferriten utgör ett filter mot elektromagnetisk störning. Vid slutlig anslutning av pumpen till elmatning ska eventuella fördragna kablar som finns på vissa av våra pumpar tas bort. Denna förinstallation används i själva verket bara för tester på fabrik under tillverkningen.

INSTALLATION

Installera poolpumpen så att tryckfallet blir så litet som möjligt samtidigt som villkoret om minsta avstånd respekteras: avståndet mellan poolpump och bassäng ska enligt installationsstandard vara minst 3,5 meter. Sugledningen ska installeras med en lätt stigning mot pumpaxeln. Kontrollera att anslutningarna är väl åtdragna och täta. Var emellertid nog med att inte blockera rörledningarna för mycket. Använd bara Teflon för att hålla plastmaterialet tätt. Sugledningen ska ha minst lika stor diameter som utloppsledningen. Undvik placering i fuktiga utrymmen eller sådana med dålig luftväxling. Motorn kräver att kylluften kan cirkulera fritt. Installera pumpen under ett skydd så att manöverboxen inte utsätts för kraftiga vattenstänk.

ANVISNINGAR FÖR START OCH LUFTNING: fyll förfilterhuset med vatten upp till sugslangens nivå. Kör aldrig pumpen utan vatten. Vattnet behövs för kylningen och för att smörja den mekaniska stängningsanordningen. Öppna alla ventiler till sug- och utloppsslangarna och i förekommande fall till luftningen av filtret (all luft i sugledningen ska avlägsnas). Starta enheten och vänta en stund tills pumpen luftats. Fem minuter är inte för lång tid för en god luftning (tiden beror på sughöjden och sugslangens längd). Se felsökningsguiden om pumpen inte startar eller inte luftas.

ANVÄNDNING

Presentation av användargränssnittet:

Inställningar och varvtalskontroll når man med hjälp av användargränssnittet till pumparna med variabelt varvtal. Med hjälp av uppåt- och nedåtpilarna kan driftvarvtalet och de olika inställningarna justeras. Med hjälp av användargränssnittet kan man även spara ett varvtal i stället för ett annat som är förinställt från fabrik.

ANVÄNDNING AV FJÄRRKONTROLLEN

1. PRESENTATION

Pumpen med varierbar hastighet från Hayward® styrs med hjälp av en fjärrkontroll som gör det möjligt att se funktionsparametrarna, ställa in dem samt programmera timer-läget.

1	LED-lampan aktiverad
2	LCD skärm visning
3	Val av hastighet
4	Växla mellan läge manuell/timer
5	Inställningsknappar upp/ner
6	Knapp på/av
7	Knapp för visning av parametrarna
8	LED-lampa för vald hastighet

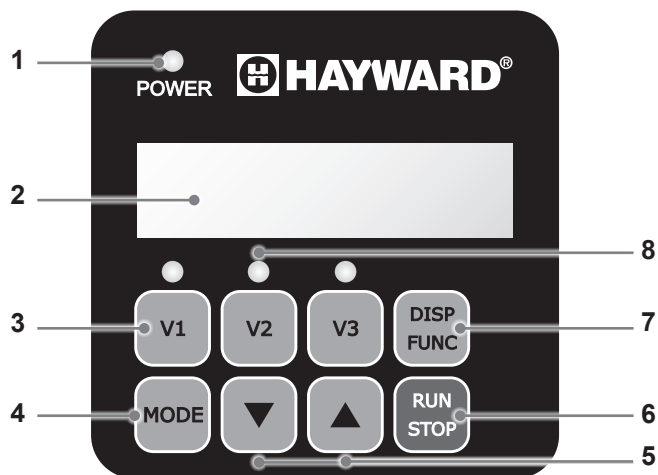

Pumpen levereras med **STANDARDPARAMETRAR** (fabriksinställningar):

Initiering längd	Initiering hastighet (rpm)	V1 (rpm)	V2 (rpm)	V3 (rpm)	Skimmer längd (min)	Skimmer cykel (tim)	Skimmer hastighet (rpm)
240	3000	1500	2400	3000	15	1 tim	2800

rpm: Rotationer per minut

ANVÄND ENDAST HAYWARD® ORIGINAL RESERVDLAR

2. PUMPENS FUNKTIONSLÄGEN

2.1 Manuellt läge

I manuellt läge startar eller stoppar användaren pumpen manuellt, beroende på när poolen används.

- När pumpen sätts på startas en initieringsfas (a).

Denna fas är justerbar (hastighet och längd, § 4.2). Initieringen kan avbrytas under starten (§ 3.2) eller inaktiveras med hjälp av inställningarna.

- Pumpens hastighet stabiliseras sedan på ett konstant värde (b) (standardstabilisering är hastighet V2). Denna hastighet kan väljas och justeras av användaren (§ 3.3).
- Efter stopp/omstart kommer pumpen att stabilisera sig själv på senast sparade hastighet.

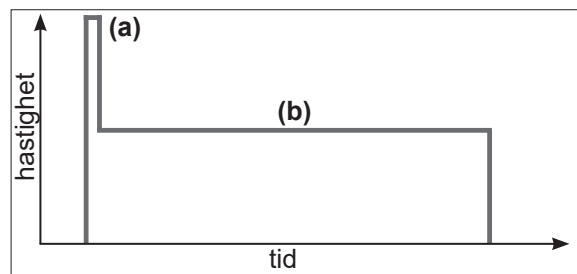

2.2 Skimmer

Funktionen skimmer gör det möjligt att ta bort skum från vattenytan, särskilt i syfte att förhindra ansamling och stagnation av smuts på poolens yta.

- Den här funktionen är automatisk: pumpen fungerar på en högre hastighet (c) under en period och en justerbar cykel.
- Efter denna hastighetsökning, återgår pumpen till normal hastighet, antingen i manuellt läge eller timer-läge.
- Skimmerfunktionen kan inaktiveras (se inställningar § 4.3).

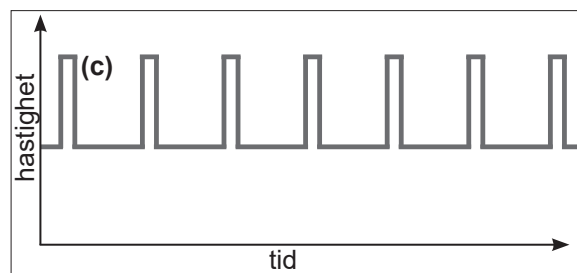

2.3 Timer-läge

I Timer-läge, är pumpens drift automatiserad 24 timmar om dygnet. Olika hastighetssekvenser (d) kan programmeras av användaren. De kommer att väljas beroende på installation (värmeförbrukning, energisparande, osv ...) och beroende på när poolen används.

- Om skimmer-funktionen är aktiverad, överlappar den dessa sekvenser.
- Pumpen kan stoppas (pausas) i timer-läget. Vid omstart kommer hastigheten att förbli desamma som nuvarande timer.
- För att ställa in timer-läget gå till § 4.5.

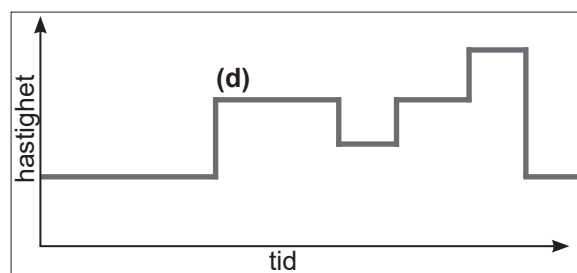

2.4 Växla mellan Manuell/Timer-läge

För att ändra läge tryck på knappen enligt bilden nedan:

Manuellt läge

Visning av hastighet utan prefix

En lysdiod indikerar vald hastighet (V2 är standard)

Timer-läge

Visning av hastighets med prefixet "t"

Lysdioder är släckta

2.5 Anslutning av digitala ingångar

△ OBS: Innan elarbeten utförs på pumpen, koppla bort den från sektorn och vänta i 5 min.

Filtreringspumpen är utrustad med en 3 meter lång 5-ledarkabel som möjliggör anslutning av 4 digitala ingångar eller 4 potentialfria torra kontakter (Öppen/Stängd).

Exempel på användning av digitala ingångar

- Påverka hastighet och flöde som krävs för väl fungerande perifera enheter såsom en värmepump, en rulljalusi eller en robotdammsugare, etc...
- Installera påminnelsekommando på användargränssnittet. Dessa digitala ingångar gör det möjligt att fjärrstyra, från en distans på 3 meter, funktionen Run/Stop samt de 3 hastigheterna (V1-V2-V3).

Tilldelning av kablarna		
DI1	Brun	Hastighet V1
DI2	Grön	Hastighet V2
DI3	Vit	Hastighet V3
DI4	Röd	Run/Stop
C	Svart	Gemensam

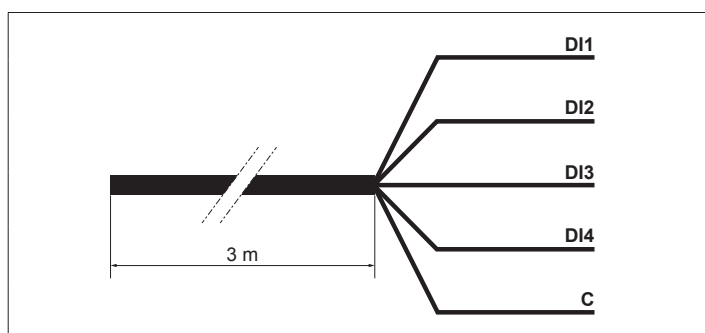

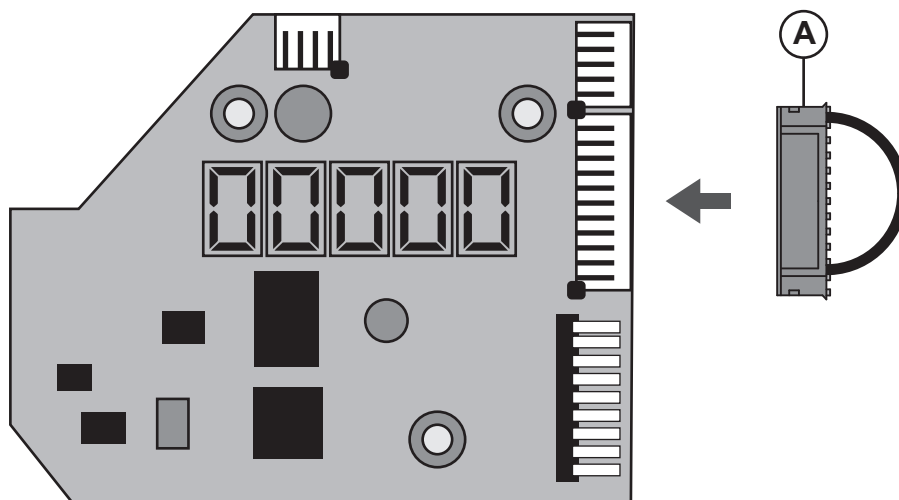

Obs:

- Vid partiell användning av de digitala ingångarna skall oanvända sladdar isoleras elektriskt.
- Vid icke-användning av digitala ingångar, sätt i kontakten (A) i stället för 5-ledarkabeln (se figur nedan).



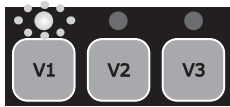

ANVÄND ENDAST HAYWARD® ORIGINAL RESERVDLAR

Funktion med de digitala ingångarna

<p>De digitala ingångarna kan användas i manuellt läge eller timerläge. De har högsta prioritet: de har högsta prioritet av alla funktioner under användning. Bara knapparna Run/Stop och DISP/FUNC förblir aktiva.</p>	→	
	→	
<p>När en digital ingång används, blinkar den LED som är associerad med den aktuella hastigheten snabbt (DI1 = V1, DI2 = V2 eller DI3 = V3).</p>	→	

<p>För att uppnå en åtgärd av de digitala ingångarna, måste ingång DI4 stängas.</p>	→	DI4 Run/StopStängd		
<p>Om flera digitala ingångar kopplas om samtidigt, kommer bara en att utföras i enligt prioriteringstabellen nedan.</p>		DI1 = V1	DI2 = V2	DI3 = V3
	DI1 = V1	V1	V2	V3
	DI2 = V2	V2	V2	V3
	DI3 = V3	V3	V2	V3

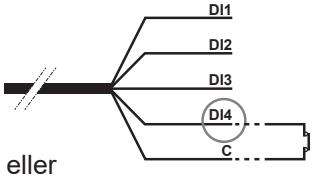
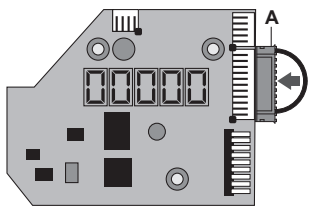
Obs: När åtgärden som associeras med den digitala ingången är klar (kontakten öppen), återupptar filtreringspumpen det aktuella driftläget.

<p>Om den digitala ingången DI4 är öppen startar filtreringspumpen inte och dSTOP visas på pumpens skärm.</p> <ul style="list-style-type: none"> • Stäng ingången DI4. • Tryck eventuellt på RUN/STOP för att starta filtreringspumpen. 	→	
	→	 <p>eller</p> 
	→	

3. ANVÄNDNING

3.1 Aktiverad







Indikeringslampan "Power" tänds och skärmen utför ett LCD-test och visar sedan programversionen

→



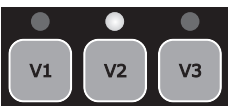



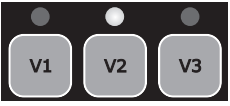

→

3.2 Initieringsfas

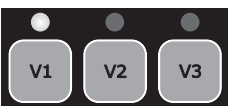
Efter det att pumpen aktiverats, startas initieringsprocessen automatiskt (det samma gäller efter omstart av pumpen).



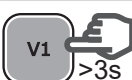
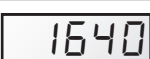

<p>Automatisk start av initieringsprocessen:</p> <ul style="list-style-type: none"> Hastigheten ökar upp till 3000 rpm och den hålls under 240 sekunder (standardvärde) 	 → 
<p>Slutet på initieringsprocessen:</p> <ul style="list-style-type: none"> Enligt standardinställningarna stabiliseras hastigheten på V2 eller på den senast lagrade hastigheten Motsvarande LED kommer lysa (manuellt läge) 	→  
<p>Visa initieringens återstående tid:</p> <ul style="list-style-type: none"> Tryck på DISP/FUNC Återstående tid visas i s 	 → 
<p>För att avbryta innan initieringsfasens slut:</p> <ul style="list-style-type: none"> Tryck på RUN/STOP Enligt standardinställningarna stabiliseras hastigheten på V2 eller på den senast lagrade hastigheten 	 →  

3.3 I manuellt läge: urval, inställning och lagring av hastighet

<p>För att välja en hastighet:</p> <ul style="list-style-type: none"> Tryck på någon av hastighetsknapparna Standardvärdet visas (i rpm) Motsvarande LED kommer lysa (manuellt läge) 	 →  
<p>För att ställa in ett nytt värde för hastigheten:</p> <ul style="list-style-type: none"> Tryck på inställningsknapparna upp/ner LED-lampan blinkar: inställning pågår Ställa in önskat värde (från 600 till 3000 rpm) 	 →  
<p>För att spara ett nytt värde för hastigheten:</p> <ul style="list-style-type: none"> Tryck på hastighetsknappen i 3 sekunder LED-lampan får ett fast sken när hastigheten har lagrats 	 →  

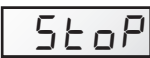
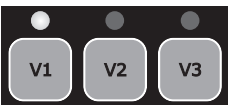
Obs: Vattenflödet som genereras av pumpens hastighet måste anpassas till kapaciteten i installationen (filter, rör...). Om du känner dig osäker, ring en professionell.

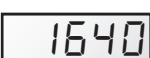
3.4 Stoppa/starta om pumpen

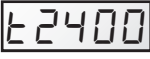
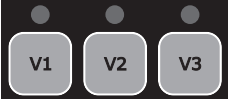









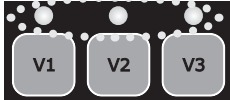

<p>För att stoppa pumpen:</p> <ul style="list-style-type: none"> Tryck på RUN/STOP Pumpen stannar, LED-lampan för hastighet tänds I manuellt läge visar skärmen "StoP" med fast sken <p>I timer-läge visar skärmen "StoP" med blinkande sken</p>	 →   
<p>För att starta om pumpen:</p> <ul style="list-style-type: none"> Tryck på RUN/STOP Pumpen startar i initieringsfasen (§ 3.2) Hastigheten stabiliseras: <p>i manuellt läge med det senast lagrade värdet för hastighet i timer-läge enligt nuvarande timer</p>	 →   →  

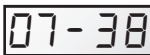
4. INSTÄLLNINGAR

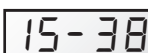
Obs: För att komma åt inställningarna måste pumpen vara aktiverad och i **manuellt läge** (§ 2.4), stoppad eller påslagen men ej i initieringsläge.

Om ingen knapp trycks ned under 2 minuter, återgår visningen till normal (hastighet eller stoP) och inställningarna sparas inte.













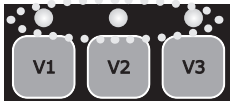

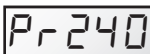





4.1 Inställning av klocka

<ul style="list-style-type: none"> Tryck i 3 sekunder på DISP/FUNC De 3 lysdioderna blinkar Skärmen visar "ConF" och sedan "hr" 						
<ul style="list-style-type: none"> Tryck på DISP/FUNC, skärmen visar den interna klockans tid (hh - min) 						
<ul style="list-style-type: none"> Tryck på inställningsknapparna upp/ner för att ställa in timmar/minuter 						
<ul style="list-style-type: none"> Tryck på RUN/STOP för att avsluta och spara Skärmen visar aktuell hastighet eller StoP 						

Obs: Den interna klockans inställning är viktig om pumpens skall användas i läge **Timer**.

Inställningen förblir lagrad när pumpen stängs av.

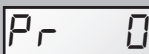
4.2 Inställning av initiering

<ul style="list-style-type: none"> Tryck i 3 sekunder på DISP/FUNC De 3 lysdioderna blinkar och skärmen visar "ConF" 				
<ul style="list-style-type: none"> Tryck på DISP/FUNC tills skärmen visar "Pr 240" längd på standardinitieringen 				
<ul style="list-style-type: none"> Tryck på inställningsknapparna upp/ner för att visa önskad längd (från 0 s 300 s) 				
<ul style="list-style-type: none"> Tryck på DISP/FUNC: skärmen visar "o3000" som är standard för initieringshastigheten (rpm) 				
<ul style="list-style-type: none"> Tryck på inställningsknapparna upp/ner för att visa önskat värde (max 3000 s) 				
<ul style="list-style-type: none"> Tryck på RUN/STOP för att avsluta och spara Skärmen visar aktuell hastighet eller StoP 				
<p>Obs: Om längden på initieringen är noll visas "ProFF": initieringen är avaktiverad</p>				

4.3 Inställning för funktionen skimmer

Se § 2.2 för presentation av denna funktion

<ul style="list-style-type: none"> Tryck i 3 sekunder på DISP/FUNC De 3 lysdioderna blinkar och skärmen visar "ConF" 		→	ConF	
<ul style="list-style-type: none"> Tryck på DISP/FUNC tills skärmen visar "SFO.15" längd på standardaktiveringen för skimmer (i minuter) 		→	SFO.15	
<ul style="list-style-type: none"> Tryck på inställningsknapparna upp/ner för att visa önskad längd (från 0 s 30 min) 		→	SFO20	
<ul style="list-style-type: none"> Tryck på DISP/FUNC: skärmen visar "St 1 tim": standardlängd på skimmer-cykel 		→	St 1h	
<ul style="list-style-type: none"> Tryck på inställningsknapparna för att ställa in skimmer-cykeln till 1 tim, 2 tim eller 3 tim 		→	St 2h	
<ul style="list-style-type: none"> Tryck på DISP/FUNC: skärmen visar "S2800" som är standard för skimmerhastigheten (rpm) 		→	S2800	
<ul style="list-style-type: none"> Tryck på inställningsknapparna upp/ner för att visa önskad hastighet (från 600 s 3000 rpm) 		→	S2680	
<ul style="list-style-type: none"> Tryck på RUN/STOP för att avsluta och spara Skärmen visar aktuell hastighet eller StoP 		→	1640 / StoP	
Obs: För att stänga av skimmern, ställ in längden till noll - skärmen visar "SFoFF"		→	SFoFF	

4.4 Återställa parametrarna

Om du vill återställa standardparametrarna och rensa inställningarna för timer-läge, gör så här:

<ul style="list-style-type: none"> Tryck i 3 sekunder på DISP/FUNC De 3 lysdioderna blinkar och skärmen visar "ConF" 		→	ConF	
<ul style="list-style-type: none"> Tryck på DISP/FUNC till skärmen visar "Init" 		→	Init	
<ul style="list-style-type: none"> Tryck på inställningsknappen "upp" i 3 sekunder. Skärmen visar "donE" När återställningen har genomförts. 		→	donE → StoP	

Påminnelse: standardparametrarna och inställningsområden

	Initiering		Hastighetsknappar			Skimmer-funktion			Timer-funktion			
	Pr	o...	V1	V2	V3	SF	St	S...	t0	t1	t5	
Enhet	s	rpm	rpm	rpm	rpm	min	h	rpm	hh-min	rpm	hh-min	rpm
Standardinställning	240	3000	1500	2400	3000	15	1	2800	06-00	2400	oFF	0
Mini	0 (oFF)	600	600	600	600	0 (oFF)	1 ...	600	00-00	—	00-00	0/ 600
Maxi	300	3000	3000	3000	3000	30	... 3	3000	24-00	—	24-00	3000

4.5 Programmering av timer-läget

Med fjärrkontrollen kan du programmera flera sekvenser (se § 2.3) eller timers t0 till t5, som inte nödvändigtvis måste följa kronologisk ordning.

De timers som inte används kommer att inaktiveras.

Timern "t0" kan ställas in på 00:00, 06:00 (standard), 12:00 eller 18:00. Den kan inte inaktiveras.

Segmentshastigheten t0 är inte inställningsbar, den har en fast inställning på 2400 rpm

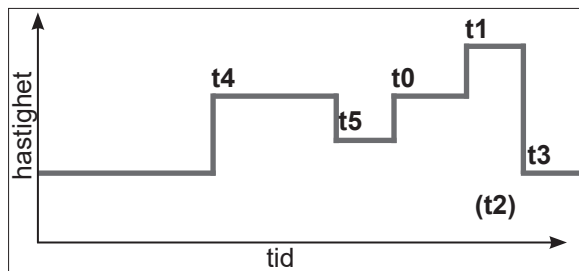

- Bestäm den hastighetsprofil som du vill programmera. Diagrammet nedan ges som exempel.
- Kontrollera att den interna klockan är korrekt inställd.

















• Tryck i 3 sekunder på DISP/FUNC De 3 lysdioderna blinkar och skärmen visar "ConF"		→	ConF			
• Tryck på DISP/FUNC 2 gånger tills skärmen visar "t0"		→	t0			
• Tryck på DISP/FUNC: skärmen visar "06-00" som är standardvärdet för t0		→	06-00			
• Tryck på inställningsknapparna för att ställa in önskad t0 (00-00, 06-00, 12-00 eller 18-00)		→	18-00			
• Tryck på DISP/FUNC: skärmen visar "t1oFF"		→	t1oFF			
• För att aktivera denna timer (exempel) tryck på knappen "upp". Skärmen visar "t1 på"		→	t1 på			
• Tryck på DISP/FUNC: skärmen visar "00-00"		→	00-00			
• Tryck på inställningsknapparna upp/ner för att ställa in önskad tid (hh-mm)		→	20-00		→	20-15
• Tryck på DISP/FUNC: skärmen visar "0"		→	0			
• Tryck på inställningsknapparna för att visa önskad hastighet (från 600 s 3000 rpm eller noll)		→	2740			
• För att hoppa till nästa timer tryck på DISP/FUNC: skärmen visar "t2oFF". I exemplet förblir denna timer inaktiv		→	t2oFF			
• Tryck på DISP/FUNC för att hoppa till nästa timer och upprepa inställningsetapperna (aktivering, timer-tid och hastighet)		→	t3oFF	etc ...		
• Tryck på RUN/STOP för att avsluta och spara Skärmen visar aktuell hastighet eller StoP		→	1640 / StoP			

5. VISNING AV PARAMETRARNA

Obs: Pumpen måste vara aktiverad, påslagen men utan initieringsfas eller avstängd.

För att bläddra bland parametrarna tryck på DISP/FUNC.

Om ingen knapp trycks under 15 sekunder, återgår skärmen till normal visning (aktuell hastighet eller stopp).

<ul style="list-style-type: none"> Tryck på DISP/FUNC: skärmen visar "hr" Tryck igen: skärmen visar intern klocka 	 → hr  → 11-45
<ul style="list-style-type: none"> Tryck på DISP/FUNC: skärmen visar "t0" tryck igen: skärmen visar tid för t0 (hastigheten för t0 är fixerad vid 2400 rpm) 	 → t0  → 12-00
<ul style="list-style-type: none"> Tryck på DISP/FUNC: skärmen visar "t1" Tryck igen: skärmen visar tiden för denna timer (hh-mm) 	 → t1  → 09-20
<ul style="list-style-type: none"> Tryck på DISP/FUNC: skärmen visar hastigheten för denna timer (i rpm) 	 → 1240
<ul style="list-style-type: none"> Tryck på DISP/FUNC etc.: skärmen visar följande timers, tid och hastighet, ända tills timer "t5" <p>Obs: Avaktiverade timers visas inte</p>	 → t2 etc ...
<ul style="list-style-type: none"> Tryck på DISP/FUNC: Skärmen visar "P - - - -" Strömförbrukning (i W värde på +/- 10 %) <p>Obs: P = 0 W när pumpen har stoppats</p>	 → P 634 / P 0
<ul style="list-style-type: none"> Tryck på DISP/FUNC: Skärmen visar "h - - - -" <p>Pumpens tidsmätare</p> <p>Obs: Mätaren visar 9999 tim</p>	 → h2857
<ul style="list-style-type: none"> Tryck på DISP/FUNC: Visa "- - - - -" Total energiförbrukning (i kWh) <p>Obs: Mätaren visar 99999 kWh</p>	 → 06542
<ul style="list-style-type: none"> Tryck på DISP/FUNC: Visa "- - - - -" Partiell energiförbrukning (i kWh) sedan senaste nollställning 	 → 00086
<ul style="list-style-type: none"> För att nollställa den partiella energiförbrukningsmätaren: Tryck knapparna upp/ner under 3 s. Meddelandet "CLEAR" anger att mätare har nollställts 	  → CLEAR
<ul style="list-style-type: none"> Tryck på DISP/FUNC: Skärmen visar "SF On" eller "SFOFF" för aktiverad/inaktiverad skimmer 	 → SF On / SFOFF
<ul style="list-style-type: none"> Tryck på DISP/FUNC: Skärmen visar "t - -" <p>Temperatur för strömmodul (i °C)</p>	 → t 74
<ul style="list-style-type: none"> Tryck på DISP/FUNC för att återgå till normal visning (aktuell hastighet eller stopp) 	 → 1640 / StOP t2400 / StOP

UNDERHÅLL

1. Koppla bort pumpen från elmatningen innan du öppnar locket och rengör förfiltret. Rengör regelbundet förfilterkorgen. Slå inte på korgen för att rengöra den. Kontrollera packningen till förfiltrets lock och byt vid behov.
2. Motoraxeln är monterad på självsmörjande lager som inte behöver smörjas om.
3. Håll motorn ren och torr och se till att inget sitter i vägen för ventilationsöppningarna.
4. Den mekaniska förslutningsanordningen kan ibland börja läcka och ska då bytas.
5. Med undantag för rengöring av bassängen ska alla reparations-, underhålls- och serviceåtgärder utföras av personal som godkänts av Hayward® eller av kvalificerad person.

Slitdelar på pumpen som nämns nedan bör underhållas enligt deras beräknade livslängd:

Uppskattad livstid för slitdelar:

Saft mekanisk tätning	1 år
Motorlagerkit	1 år
Täckningsset (sil, hus, skut, avlöp)	2 år
Kondensator	2 år

VINTERRUSTNING

1. Töm pumpen genom att ta bort alla tömningspluggar och förvara dem i förfilterkorgen.
2. Koppla från pumpen, ta av alla rörledningar och förvara hela enheten på en torr plats med god luftväxling eller vidtag i vilket fall följande försiktighetsåtgärd: koppla från pumpen, ta bort de fyra bultar som håller fast motorfästet och förvara hela enheten på en torr plats med god luftväxling. Skydda sedan pumphuset och förfilter genom att täcka över dem.

ANMÄRKNING: Rengör alla inre delar innan du tar pumpen i drift och ta bort damm, kalk m.m.

FELSÖKNING OCH ÅTGÄRDER

A) Maskinen startar inte

1. Kontrollera elanslutningar, brytare och reläer samt jordfelsbrytare och säkringar.
2. Kontrollera för hand att motorn går runt.
3. Kontrollera att varvtalen V1, V2 och V3 inte är programmerade till 0 v/min och återställ i förekommande fall till parametrar från fabrik (se § 4.4).
4. Om skärmen visar en av felkoderna nedan, kontakta din installatör:

E r r 0 1	Fortsatt underspänning av linjen	E r r 1 0	Problem med inre strömförsörjning
E r r 0 2	Fortsatt överspänning av linjen	E r r 2 0	Fel vid start
E r r 0 4	Överhettning av kraftmodulen	E r r 6 4	Internt kortslutningsproblem
E r r 0 5	Överhettning av motorn	E r r 9 7	Multipla problem
E r r 0 7	Överintensitet	E r r 9 8	Kommunikationsproblem
		d 5 t o P	Se sidan 104

B) Motorn stannar – kontrollera

1. kablar, anslutningar, relän m.m.,
2. spänningsfallet över motorn (orsakas ofta av för kläna kablar) och
3. att det inte finns någon kärvning eller överbelastning (genom att mäta absorberad strömstyrka).

ANMÄRKNING: Pumpmotorn har ett motorskydd som vid överbelastning bryter kretsen automatiskt för att undvika att motorn skadas. Det löser ut vid onormala driftförhållanden vars orsaker man måste utreda och åtgärda. Så snart normala driftförhållanden åter föreligger startar motorn om utan ytterligare åtgärd.

C) OLOAD visas på displayen (problem med överbelastning eller överhettning)

1. Kontrollera att motorn går runt obehindrat
2. Kontrollera att inte smuts hindrar turbinen från att rotera fritt
3. Kontrollera att motorn har tillräcklig ventilation
4. Tryck på knappen På/Av när du har åtgärdat problemet

ANVÄND ENDAST HAYWARD® ORIGINAL RESERVDLAR

D) Pumpen luftas inte

1. Kontrollera att förfilterhuset är ordentligt fyllt med vatten, att lockets packning är ren och sitter rätt och att det inte kan komma in någon luft. Dra vid behov åt lockets spärrskruvar.
2. Kontrollera att alla sug- och utloppsventiler är öppna och fria från hinder och att alla bassängens utsugsöppningar står helt under vatten.
3. Kontrollera om pumpen suger genom att frigöra den sugledning som är närmast pumpen:
 - a) om pumpen inte suger trots att den fyllts med tillräckligt med vatten för luftning
 1. Dra åt bultar och tillbehör till ledningarna på sugsidan.
 2. Kontrollera spänningen så att pumpen går med rätt varvtal.
 3. Öppna pumpen och kontrollera att det inte finns något inuti den som hindrar rotationen.
 4. _Ställa in tillräcklig initieringshastighet
 5. _Rengör filter och försök igen
 6. Byt den mekaniska förslutningsanordningen.
 - b) Försök initiera i läge återcirkulation. kontrollera sugledning och förfilter om pumpen suger normalt, så att de inte är igensatta eller släpper in luft.

E) Pumpen för oväsen – kontrollera

1. att inget insug av luft eller luft i sugledningen gör att pumpen hackar dovt,
2. att det inte förekommer någon kavitation på grund av för liten diameter på sugslangen eller att denna är i kläm. Även en sugledning med för stor dimension kan ge upphov till sådan kavitation. Använd rätt ledningar eller lufta dem vid behov.
3. att det inte förekommer vibrationer på grund av felaktig montering,
4. att det inte finns något främmande föremål i pumphuset och
5. att motorlagren inte kärvar på grund av för stort spel, rost eller lång tids överhettning.



HAYWARD®

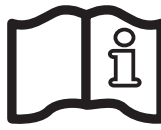
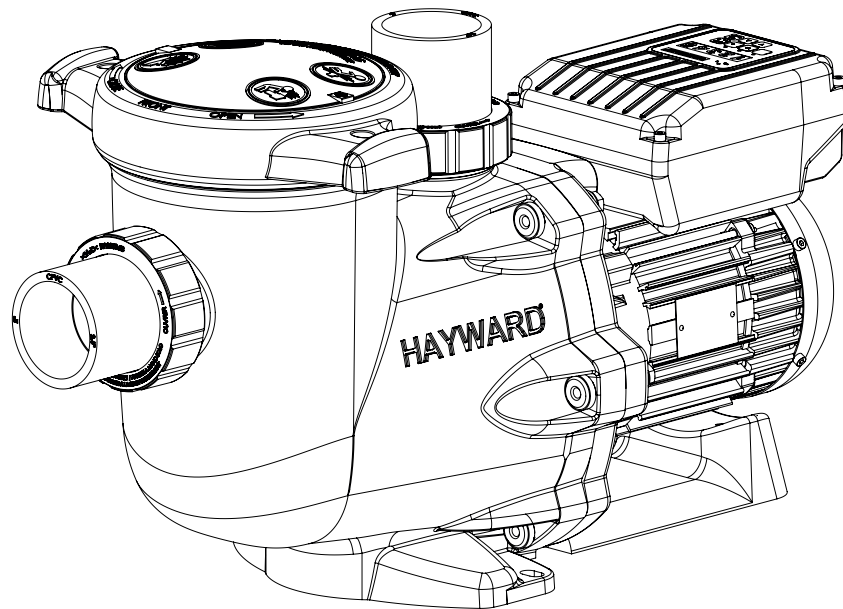

SENTRIFUGALPUMPE MED VARIABEL HASTIGHET

BRUKERVEILEDNING

TA VARE PÅ DENNE VEILEDNINGEN FOR SENERE BRUK



**ADVARSEL: Elektrisk fare. Unnlatelse av å følge instruksjonene kan føre til alvorlig skade eller død.
TIL BRUK I SVØMMEBASSENG**

⚠ OBS – Før du åpner lokket for filterrengjøring, koble pumpen helt fra strømforsyningen.

⚠ OBS – Alle elektriske tilkoblinger må gjøres av en kvalifisert autorisert profesjonell elektriker og i samsvar med gjeldende forskrifter i installasjonslandet, dersom dette ikke er tilfelle, den internasjonale standarden IEC 60364-7-702.

⚠ OBS – Pass på at maskinen kun er koblet til en 230 V_~-kontakt beskyttet mot kortslutning. Pumpen skal drives ved hjelp av en skilletransformator eller via en reststrømenhet (RCD) med en nominell reststrøm som ikke overstiger 30mA.

⚠ OBS – Pass på at barn ikke leker med dette apparatet. Hold fingre og fremmedlegemer unna åpninger og bevegelige deler.

⚠ OBS – Motoren må plasseres riktig på bakken. Koble jordledningen til den grønne skruen på basen, og for fastkoblede enheter bruk riktig jorduttak.

⚠ OBS – Bruk en motortilkoblingssko for å koble motoren til andre tilkoblingsdeler ved å bruke lederen med riktig størrelse som spesifisert i elektriske koder.

⚠ OBS – Når du gjør slike elektriske tilkoblinger, se gjennom diagrammet under motorens koblingsboksdeksel. Sørg for å kontrollere at elektriske tilkoblinger er tette og forseglet før du kobler til strøm. Fjern alle deksler før bruk.

⚠ OBS – Forsikre deg om at den elektriske forsyningsspenningen som kreves av motoren, samsvarer med den til distribusjonsnettverket og at de elektriske forsyningskablene tilsvarer kraften og strømmen til pumpen.

⚠ OBS – Les og følg alle instruksjonene i denne brukerhåndboken og merket på utstyret. Unnlatelse av å følge instruksjonene kan forårsake kroppsskade.

Dette dokumentet skal leveres til bassengeier, som skal oppbevare det på et trygt sted.

⚠ OBS – Barn over 8 år og personer uten nødvendig kunnskap eller erfaring eller med fysiske, mentale eller sensoriske funksjonshemminger kan bruke dette apparatet hvis de har mottatt passende instruksjoner og forstår farene forbundet med bruken. Barn må ikke leke med apparatet. Rengjøring og brukervedlikehold må ikke utføres av barn, med mindre de er over 8 år og er under tilsyn. Oppbevar apparatet og ledningen utilgjengelig for barn under 8 år.

⚠ OBS – Pumpen er konstruert for kontinuerlig drift ved en maksimal vanntemperatur på 35°C.

⚠ OBS – Bruk kun originale Hayward®-reservedeler.

⚠ OBS – Hvis strømledningen er skadet, må den skiftes ut av produsenten, forhandleren eller lignende kvalifiserte personer for å unngå farer.

⚠ OBS – En ekstern bryter med all-polet kontaktseparasjon som gir fullstendig frakobling under kategori III overspenningsforhold, må installeres i faste ledninger som samsvarer med ledningsregler for frakobling fra strømforsyningen.

⚠ OBS – Ikke bruk bassengpumpen hvis tilkoblingskabelen eller motorens koblingsbokshus er skadet. Dette kan forårsake elektrisk støt. En skadet strømkabel eller motorkoblingsboks må umiddelbart skiftes ut av en tekniker eller tilsvarende kvalifisert person for å unngå fare.

⚠ OBS – Denne bassengmotoren er IKKE utstyrt med et sikkerhetsvakuumsfrigjøringsystem (SSLV). SSLV hjelper til med å forhindre drukning fra kroppsklemming i nedsenket avløp. I noen bassengkonfigurasjoner, hvis en persons kropp dekker avløpet, kan personen bli fanget ved sug. Avhengig av bassengkonfigurasjonen kan det være nødvendig med en SSLV for å oppfylle kravene til lokale koder.

⚠ OBS – Denne pumpen inneholder et batteri som av sikkerhetsgrunner må utføres av en kvalifisert teknisk service.

GENERELT

Gratulerer, du har nettopp kjøpt en Hayward-pumpe med variabel hastighet.

Hayward®-pumpene med variabel hastighet® har en motor med permanent magnet med elektronisk AC-bryter av siste generasjon. Denne motoren styres av en mikroprosessor som er forbundet med en frekvensvariator for følgende karakteristikker:

- Visning av rotasjonshastigheten på kontrollskjermen
- 3 forhåndsdefinerte rotasjonshastigheter fra fabrikk (knappene V1, V2, V3), hastigheter som kan reguleres av brukeren
- Systematisk aktivering ved hver oppstart, justerbar hastighet og aktiveringstid
- Skimmer-funksjon, skumming av vannoverflaten
- Programmerbar Timer-funksjon
- Visning av øyeblikkelig, forbrukt styrke
- Visning av totalt og delvis energiforbruk
- Visning av pumpens driftstid
- Svakt støynivå
- Konstruksjonsstandard TEFC IP55

Installer pumpen på god avstand fra bassenget for å redusere mest mulig koblingslinjen mellom sugingen og pumpen slik at du reduserer unyttige og overdrevne trykktap i det hydrauliske systemet.

Det er imidlertid påbudt å overholde sikkerhetsavstanden i samsvar med gjeldende installasjonsnorm (minst 3.5 meter fra bassenget). Installere og bruke produktet ved en høyde mindre enn 2000m.

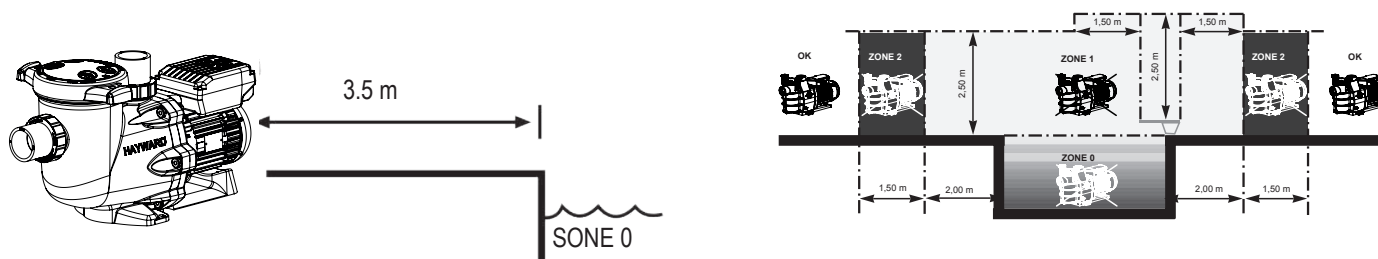

Installer pumpen på et luftet, tørt rom. Forutsett fritt rom på 0,5 m rundt pumpen. Motoren krever at luften sirkulerer fritt rundt pumpen slik at den luftes naturlig. Sjekk regelmessig at verken gjenstander, blader eller noe annet tilstopper motorens kjølesystem.

Pumpen må installeres slik at den utvendige frakoblingsbryteren som er innebygd i den fastsittende boksen, er synlig og lett tilgjengelig. Bryteren må være nær pumpen.

Pumpen skal installeres permanent på en sokkel av betong med skruer på Ø 8 mm som er tilpasset betongen og skrus på stedene der det er laget hull. Stoppskiver skal installeres for å hindre at montasjeskruene løsner med tiden. Hvis pumpen skal monteres på et tregulv, må man bruke treskruer med sekskanthode på Ø 8 mm som er egnet for tre, samt bremseskiver som er beregnet på å hindre at de løsner med tiden.

Installer pumpen på avstand slik at kontrollboksen ikke utsettes for sterk vannsprut.

Hayward®-pumpenes lydtrykk er under 70 dBA.

Nødvendige tiltak:

- Koble pumpen til jordingen: La aldri pumpen gå uten at den er forsvarlig jordet.
- Koble pumpen til en kabel av typen H07RN-F 3G1,5mm².
- Bruk en 30 mA-differensialbeskyttelse som skal beskytte personer mot elektriske støt forårsaket av et eventuelt brudd på utstyrets elektriske isolasjon.
- Bruk en beskyttelse mot kortslutninger (kaliberet defineres ut fra verdien på motorens merkeplate).
- Bruk en enhet for frakobling fra nettstrømmen som har en avstand for åpning av samtlige poler som sørger for komplett bryting i henhold til kategori III for overspenningsvern.

⚠ OBS: Vent 5 minutter etter å ha koblet pumpen helt fra nettstrømmen før du griper inn på motoren eller koblingsboksen: Fare for elektrisk sjokk som kan medføre livsfare.

De elektriske motorene i våre pumper er utstyrt med en termisk beskyttelse. Denne beskyttelsen reagerer ved overlast eller unormal oppvarming av motorspolingen. Denne beskyttelsen reaktiveres automatisk når spolingens temperatur synker.

Hvis regelverket påbyr det og uansett hva slags motor som brukes må du i tillegg til innretningene nevnt ovenfor installere en magnetisk-termisk beskyttelse som må kalibreres i henhold til angivelsene på motorens merkeplate.

Tabellen på side 169 angir de forskjellige karakteristikene til motoren som våre pumper er utstyrt med.

Elektrisk tilkobling: Pass på at tilførselsspenningen som trengs for produktet, svarer til spenningen i distribusjonsnett og at strømledningens diameter og lengde er tilpasset til pumpens effekt og strømstyrke.

Alle pumpens elektriske tilkoblinger og eventuelt skifte av strømledning må utføres av en av kvalifisert fagperson for å unngå enhver fare.

Ved elektriske koblinger må du alltid respektere merkingen under koblingsklemmene.

Sjekk at de elektriske koblingene er trukket til og tette før strømmen slås på.

Pass på at kabelen føres gjennom åpningen og ferritten. Pakkboksen sørger for tetthet rundt kabelen, og ferritten filtrerer elektromagnetiske forstyrrelser.

Den eventuelle forhåndskablingen som enkelte av våre pumper er utstyrt med, skal fjernes når pumpen kobles definitivt til strømtilførselen. Dette forhåndsstyret brukes kun for tester på fabrikken under produksjonsfasene.

INSTALLASJON

Installer bassengpumpen slik at trykktapet reduseres mest mulig, samtidig som påkrevd avstand overholdes, dvs. minst 3,5 meter mellom pumpen og bassenget som angitt i installasjonsnormen. Sugeledningen skal installeres med en svak stigning opp mot pumpeaksen. Pass på at koblingene er godt tiltrukket og at de er tette. Unngå imidlertid å sperre slanger og rør på overdreven måte. Når det gjelder plast, skal tettheten kun utføres med teflon. Sugelangens skal ha en diameter som er større enn eller lik utløpslangens. Unngå steder uten ventilasjon og våte steder. Motoren krever at kjøleluften sirkulerer fritt. Installer pumpen på avstand slik at kontrollboksen ikke utsettes for sterk vannsprut.

VIKTIG: Sjekk rotasjonsretningen før motoren kobles til definitivt.

INSTRUKSJONER FOR START OG INNSUGING: Fyll forfilterets legeme med vann opp til sugeslangens nivå. La aldri pumpen gå uten vann, da det trengs vann for å kjøle og smøre den mekaniske ventilen. Åpne alle ventilene til suge- og utløpsledningene samt filterets innretning for lufttømming dersom denne finnes. (All luft i sugeledningene må være tømt ut). Start enheten og gi litt tid til innsuging. Fem minutter er ikke for mye for å få pumpen til å suge (denne innsugingen avhenger av sugehøyden og sugeslangens lengde). Hvis pumpen ikke starter eller ikke suger, må du sjekke avsnittet om feilsøking.

BRUK AV BETJENINGSBOKSEN

1. PRESENTASJON

Hayward®-pumpen med variabel hastighet styres med en betjeningsboks som gjør det mulig å se driftsparametrene, stille inn disse og programmere Timer-modus.

1	LED-lampe for spenningstilførsel
2	LCD visnings skjerm
3	Hastighetsvalg
4	Skifte mellom Manuell modus / Timer-modus
5	Innstillingsknapper opp / ned
6	Start- / Stopp-knapp
7	Knapp for visning av parametre
8	LED-lamper for valgt hastighet

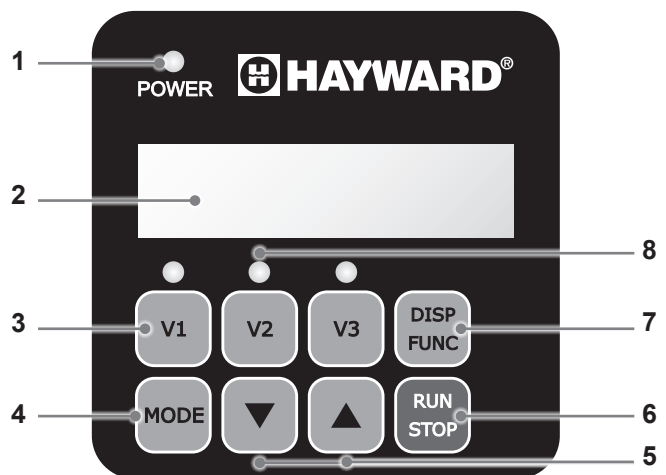

Pumpen leveres med **PARAMETRE SOM STANDARD** (fabrikkinnstillinger):

Aktiveringstid (s)	Aktiveringshastighet (rpm)	V1 (rpm)	V2 (rpm)	V3 (rpm)	Skimmer-varighet (min)	Skimmer-syklus (t)	Skimmer-hastighet (rpm)
240	3000	1500	2400	3000	15	1t	2800

rpm: Rotasjoner Pr. Minutt

BRUK UTELUKKENDE OPPRINNELIGE RESERVEDELER FRA HAYWARD®

2. PUMPENS DRIFTSMODI

2.1 Manuell modus

I Manuell modus starter eller stanser brukeren pumpen manuelt i forhold til bruken av svømmebassenget.

- Når pumpen startes, settes det i gang en aktiveringsfase (**til**). Denne fasen kan stilles inn (hastighet og tid, § 4.2). Aktiveringen kan avbrytes under oppstarten (§ 3.2) eller deaktiveres med innstillingene.
- Deretter stabiliserer pumpens hastighet seg på en konstant verdi (**b**) (som standard stabilisering ved hastighet V2). Denne hastigheten kan velges og stilles inn av brukeren (§ 3.3).
- Etter en oppstart/gjenoppstart, vil pumpen stabilisere seg på den sist lagrede hastigheten.

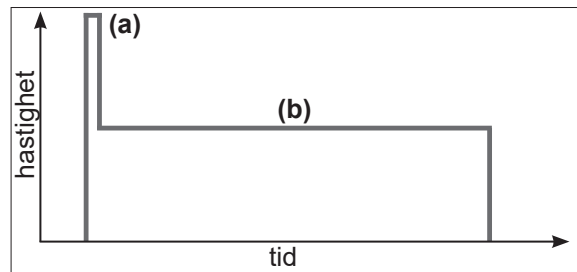

2.2 Skimmer

Skimmer-funksjonen gjør det mulig å skumme vannoverflaten, spesielt for å unngå opphoping og stagnering av skitt og urenheter på svømmebassengets overflate.

- Denne funksjonen er automatisk pumpen fungerer ved en høyere hastighet (**c**) over en tid, og i henhold til syklus som begge kan stilles inn.
- Etter denne hastighetsøkningen, vil pumpen gå tilbake den normale hastigheten igjen, enten den er i Manuell modus eller Timer-modus.
- Skimmer-funksjonen kan deaktiveres (se innstillinger § 4.3).

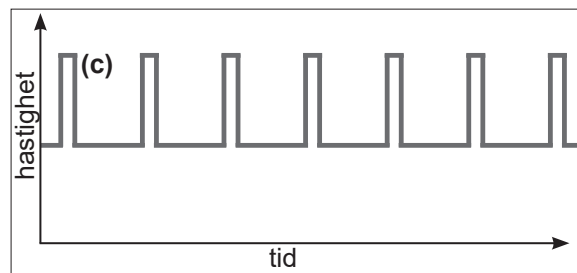

2.3 Timer-modus

I Timer-modus er pumpens drift automatisert 24 timer i døgnet. Det er brukeren som må programmere de ulike hastighetssekvensene (**d**). De skal velges i forhold til installasjonen (oppvarmingsmodus, energiøkonomisering, etc...) og de tidspunktene som svømmebassenget er i bruk.

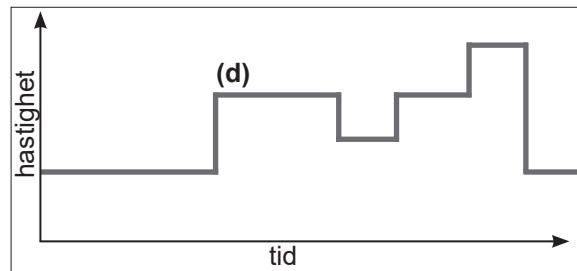

- Dersom Skimmer-funksjonen er aktivert, opptrer den samtidig med disse sekvensene.
- Pumpen kan stanses (settes på pause) i Timer-modus. Ved gjenoppstart vil hastigheten være den samme som for den pågående Timer-sekvensen.
- For å programmere Timer-modus, se § 4.5.



2.4 Skifte mellom Manuell modus / Timer-modus



Skifte av modus utføres ved å trykke på knappen  som vist under:

Manuell modus

Visning av hastighet uten prefiks  → 

Den lysende LEDen angir den valgte hastigheten (V2 som standard) 

Timer-modus

Visning av hastighet med prefiks "t"  → 

LEDene er slukket 

2.5 Kobling av eksterne digitale innganger

⚠ OBS: Hvis du skal foreta noe vedlikeholdsarbeid på pumpen, må du først koble den fra strømmen, og vente i 5 minutter.

Filtreringspumpen er utstyrt med en 5-ledningskabel på 3 meter, som brukes for å koble til 4 digitalinnganger eller potensialfrie kontakter (Av/På).

Eksempel på bruk av digitale innganger

- Justere hastighet eller mengde som trenges for optimal drift av eksternt utstyr, som for eksempel en varmpumpe, et rullende sikkerhetstrekk, en rengjøringsrobot, osv.
- Installere et ekstra brukergrensesnitt som tilleggsutstyr. Ved hjelp av disse digitalinngangene kan du Run/Stop en funksjon på 3 meters avstand, og velge de 3 hastighetene (V1-V2-V3).

Fordeling av ledningene		
DI1	Brun	Hastighet V1
DI2	Grønn	Hastighet V2
DI3	Hvit	Hastighet V3
DI4	Rød	Run/Stop
C	Svart	Felles

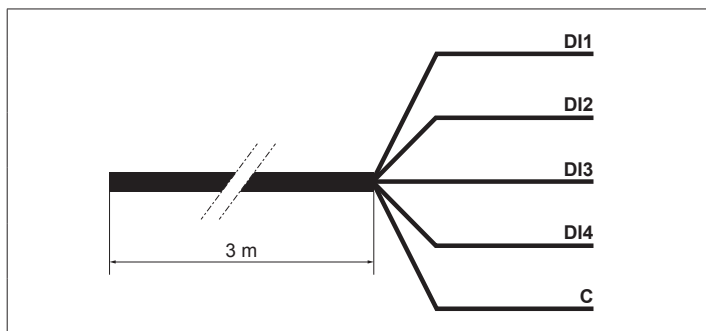

Merk:

- Hvis digitalinngangene kun brukes delvis, må du isolere de ledningene som ikke brukes.
- Hvis digitalinngangene ikke brukes, må du sette inn pluggen (A) i stedet for 5-ledningskabelen (se figur nedenfor).

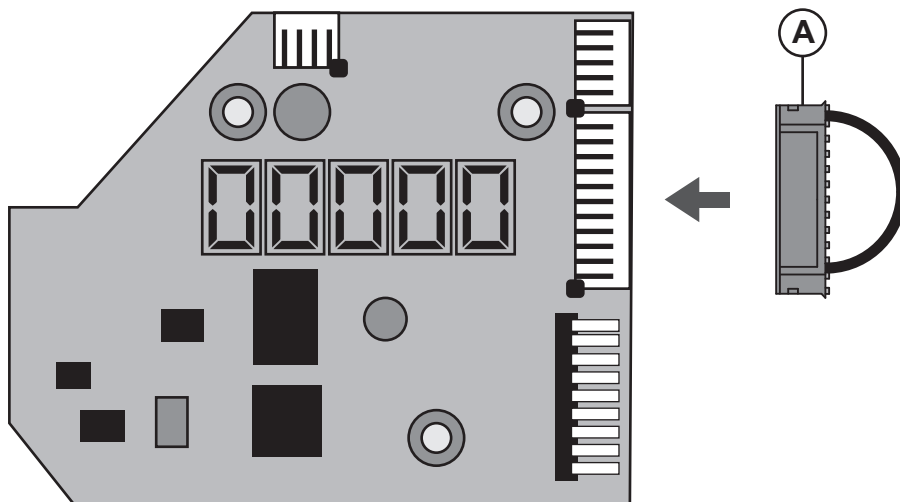



Drift med digitale innganger

<p>Digitalinngangene kan brukes i Manuell modus eller i Timer-modus. De har da høyeste prioritetsnivå: de er MASTER fremfor alle funksjoner som er i bruk. Kun Run/Stop og DISP/FUNC knappene er fortsatt aktive.</p>	→	
	→	
<p>Når en digitalinngang er i bruk, vil LED-lampen som tilsvarer valgt hastighet blinke raskt (DI1 = V1, DI2 = V2 eller DI3 = V3).</p>	→	

<p>For å kunne foreta en handling via digitalinngangene, må DI4-inngangen stenges.</p>	→	DI4 Run/Stop Stengt		
<p>Hvis flere digitalinnganger er koblet til samtidig, vil handlingene utføres én av gangen, i henhold til følgende prioritetsstabell:</p>		DI1 = V1	DI2 = V2	DI3 = V3
		DI1 = V1	V1	V2
		DI2 = V2	V2	V2
		DI3 = V3	V3	V2

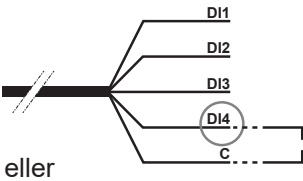
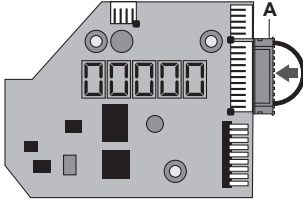

Merk: Når handlingen som er knyttet til digitalinngangen er ferdig (åpen kontakt), vil filtreringspumpen gå over til den normale driftsmodusen som var på gang.

<p>Hvis den digitale inngangen DI4 er åpen, vil filtreringspumpen ikke starte, og det vil stå dSTOP på pumpens display.</p>	→	
<ul style="list-style-type: none"> • Steng DI4-inngangen. • Trykk eventuelt på RUN/STOP for å starte filtreringspumpen. 	→	 <p>eller</p>
	→	
	→	

3. BRUK









3.1 Spenning på

"Power"-lampen lyser; skjermen utfører en LCD-test, og viser deretter programvare-versjonen

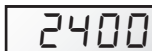



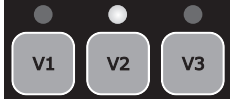

→

→

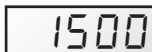
3.2 Aktiveringsfase

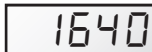
Etter å ha slått på pumpens spenningstilførsel, starter aktiveringsfasen automatisk (idem etter gjenoppstart av pumpen).

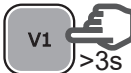
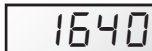



<p>Automatisk start av aktiveringsfasen:</p> <ul style="list-style-type: none"> Hastigheten økes opp til 3000 rpm og hvor den opprettholdes i 240 s (standardverdier) 		→		
<p>Slutt på aktiveringsfasen:</p> <ul style="list-style-type: none"> Som standard stabiliserer hastigheten seg på V2 eller på den sist lagrede hastigheten. Den tilsvarende LEDen lyser (Manuell modus) 		→		
<p>For å vise gjenstående aktiveringstid:</p> <ul style="list-style-type: none"> Trykk på DISP/FUNC Den gjenstående tiden vises i s 		→		
<p>For å gå ut før aktiveringstiden er ferdig:</p> <ul style="list-style-type: none"> Trykk på RUN/STOP Som standard stabiliserer hastigheten seg på V2 eller på den sist lagrede hastigheten. 		→		

3.3 I Manuell modus: valg, innstilling og lagring av en hastighet

<p>For å velge en hastighet:</p> <ul style="list-style-type: none"> Trykk på en av hastighetsknappene Verdien som standard vises (i rpm) Den tilsvarende LEDen lyser 		→		
<p>For å stille inn en ny hastighetsverdi:</p> <ul style="list-style-type: none"> Trykk på innstillingsknappene opp / ned LEDen blinker: innstilling pågår Still inn ønsket verdi (fra 600 til 3000 rpm) 		→		
<p>For å lagre den nye hastighetsverdien:</p> <ul style="list-style-type: none"> Trykk på hastighetsknappen i 3 sekunder LEDen lyser fast når hastigheten er lagret 		→		

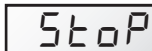
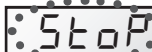
Merk: Vannmengden som pumpens hastighet genererer må være tilpasset kapasiteten til installasjonen (filter, rørsystemer...). Dersom du er i tvil, ta kontakt med en profesjonell.

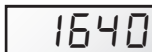
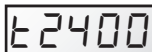
3.4 Stopp / gjenoppstart av pumpen

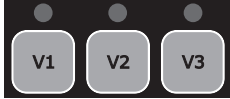













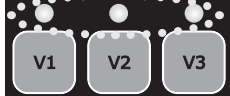

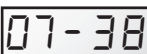
<p>For å stoppe pumpen:</p> <ul style="list-style-type: none"> Trykk på RUN/STOP Pumpen stopper, LEDen for hastighet lyser fortsatt I Manuell modus viser skjermen "StoP" fast. I Timer-modus, blinker "StoP" på skjermen. 		→	 	
<p>For å starte pumpen igjen:</p> <ul style="list-style-type: none"> Trykk på RUN/STOP Pumpen starter i aktiveringsfase (§ 3.2) Hastigheten stabiliserer seg på den sist lagrede verdien i Manuell modus, og på den samme hastigheten som for den pågående Timer-sekvensen i Timer-modus 		→	 → 	 

4. INNSTILLINGER

Merk: For å få tilgang til innstillingene, må pumpen få spenningstilførsel og **være i Manuell modus** (§ 2.4), enten stanset eller i drift utenom aktiveringsfasen.

Dersom det ikke blir trykket på noen knapper i løpet av 2 minutter, vil visningen gå tilbake til normal visning (hastighet eller StoP), og innstillingene vil ikke bli lagret.











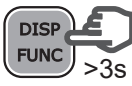

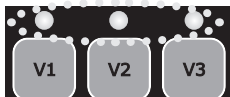















4.1 Innstilling av klokken

<ul style="list-style-type: none"> Trykk på DISP/FUNC i 3 sek. De 3 LEDene blinker. Skjermen viser "ConF", og deretter "hr" 		    
<ul style="list-style-type: none"> Trykk på DISP/FUNC, skjermen viser det interne urets klokkeslett (hh-min) 		 
<ul style="list-style-type: none"> Trykk på innstillingsknappene opp / ned for å stille inn timer / minutter. 		 
<ul style="list-style-type: none"> Trykk på innstillingsknappene opp / ned for å stille inn timer / minutter. 		 
<ul style="list-style-type: none"> Trykk på RUN/STOP for å gå ut og lagre. Visningen angir den aktuelle hastigheten eller StoP. 		 

Merk: Innstillingen av det interne uret er viktig dersom pumpen fungerer i **Timer**-modus.

Innstillingen forblir lagret når spenningstilførselen til pumpen slås av.

4.2 Innstilling av aktivering

<ul style="list-style-type: none"> Trykk på DISP/FUNC i 3 sek. De 3 LEDene blinker og skjermen viser "ConF". 		  
<ul style="list-style-type: none"> Trykk på DISP/FUNC n ganger for å få frem skjermen "Pr 240" aktiveringstid som standard (s). 		 
<ul style="list-style-type: none"> Trykk på innstillingsknappene opp / ned for å vise ønsket tid (fra 0 til 300 sek). 		 
<ul style="list-style-type: none"> Trykk på innstillingsknappene opp / ned for å vise ønsket verdi (maks. 3000 rpm) 		 
<ul style="list-style-type: none"> Trykk på DISP/FUNC: Skjermen viser "o3000" aktiveringshastighet som standard (rpm). 		 
<ul style="list-style-type: none"> Trykk på innstillingsknappene opp / ned for å vise ønsket verdi (maks. 3000 rpm) 		 
<ul style="list-style-type: none"> Trykk på innstillingsknappene opp / ned for å vise ønsket verdi (maks. 3000 rpm) 		 
<ul style="list-style-type: none"> Trykk på RUN/STOP for å gå ut og lagre. Visningen angir den aktuelle hastigheten eller StoP. 		 
<p>Merk: Dersom aktiveringstiden er på null, angir visningen "ProFF": Aktiveringen er deaktivert.</p>		   

4.3 Innstilling av Skimmer-funksjonen

Se presentasjon av denne funksjonen i § 2.2.

<ul style="list-style-type: none"> Trykk på DISP/FUNC i 3 sek. De 3 LEDene blinker og skjermen viser "Conf". 		→	Conf	
<ul style="list-style-type: none"> Trykk på DISP/FUNC n ganger for å få frem skjermen "SFO.15": Aktiveringsvarighet for Skimmer-funksjonen som standard (i minutter). 		→	SFO.15	
<ul style="list-style-type: none"> Trykk på innstillingsknappene opp / ned for å vise ønsket varighet (fra 0 til 30 min.) 		→	SFO20	
<ul style="list-style-type: none"> Trykk på DISP/FUNC: skjermen viser "St 1h": Skimmer-syklusens varighet som standard 		→	St 1h	
<ul style="list-style-type: none"> Trykk på innstillingsknappene for å stille Skimmer-syklusen inn på 1 t, 2 t eller 3 t 		→	St 2h	
<ul style="list-style-type: none"> Trykk på DISP/FUNC: skjermen viser "S2800": Skimmer-hastighet som standard (rpm) 		→	S2800	
<ul style="list-style-type: none"> Trykk på innstillingsknappene opp / ned for å vise ønsket hastighet (fra 600 til 3000 rpm) 		→	S2680	
<ul style="list-style-type: none"> Trykk på RUN/STOP for å gå ut og lagre. Visningen angir den aktuelle hastigheten eller StoP. 		→	1640 / StoP	
Merk: For å deaktivere Skimmer, still inn varigheten på null – Visningen angir "SfoFF"		→	SFO00	→ SfoFF

4.4 Gjeninitialisering av parametrene

For å gjenopprette standardparametrene, og slette innstillingene i Timer-modus, gå frem på følgende måte:

<ul style="list-style-type: none"> Trykk på DISP/FUNC i 3 sek. De 3 LEDene blinker og skjermen viser "Conf". 		→	Conf	
<ul style="list-style-type: none"> Trykk på DISP/FUNC n ganger for å få frem meldingen "Init" på skjermen. 		→	Init	
<ul style="list-style-type: none"> Trykk på innstillingsknappen "opp" i 3 sek. Visningen angir "donE" når reinitialiseringen er utført. 		→	donE	→ StoP

Husk: standardparametre og innstillingsområder

	Aktivering		Hastighetsknapp			Skimmer-funksjon			Timer-funksjon			
	Pr	o...	V1	V2	V3	SF	St	S...	t0	rpm	t1 - t5	rpm
Enhet	s	rpm	rpm	rpm	rpm	min	t	rpm	tt-min	rpm	tt-min	rpm
Som standard	240	3000	1500	2400	3000	15	1	2800	06-00	2400	oFF	0
Mini	0 (oFF)	600	600	600	600	0 (oFF)	1 ...	600	00-00	—	00-00	0/ 600
Maxi	300	3000	3000	3000	3000	30	... 3	3000	24-00	—	24-00	3000

BRUK UTELUKKENDE OPPRINNELIGE RESERVEDELER FRA HAYWARD®

4.5 Programmering av Timer-modus

Betjeningsboksen gjør det mulig å programmere flere sekvenser (se § 2.3) eller Timer-sekvensene t0 til t5, som ikke nødvendigvis bør følge en kronologisk rekkefølge.







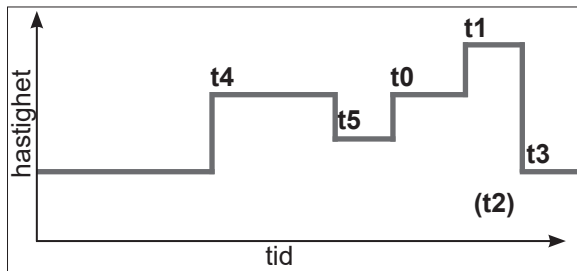





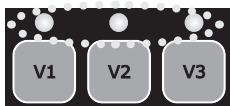
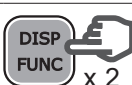

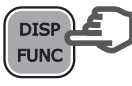
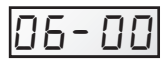











De Timer-sekvensene som ikke er i bruk, vil bli deaktivert.

Timer "t0" kan fastsettes til 00:00, 06:00 (som standard); 12:00 eller 18:00. Den kan ikke deaktiveres.

Hastigheten til segment t0 kan ikke stilles inn, det er fast på 2400 rpm.

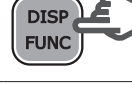
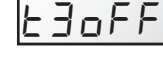

















- Strek opp den hastighetsprofilen du ønsker å programmere. Grafikken ved siden av er gitt som eksempel.
- Sjekk at det interne uret er riktig stilt.

• Trykk på DISP/FUNC i 3 sek. De 3 LEDene blinker og skjermen viser "Conf".		→				
• Trykk på DISP/FUNC n ganger for å få frem visningen "t0".		→				
• Trykk på DISO/FUNC, skjermen viser "06-00": verdi for t0 som standard		→				
• Trykk på innstillingsknappene for å fastsette ønsket t0 (00-00, 06-00, 12-00 eller 18-00)		→				
• Trykk på DISP/FUNC: skjermen viser "t1oFF"		→				
• For å aktivere denne Timeren (eksempel), trykk på knappen "opp". Skjermen viser "t1 on"		→				
• Trykk på DISP/FUNC: skjermen viser "00-00"		→				
• Trykk på innstillingsknappene ned / opp for å stille inn ønsket klokkeslett (tt-mm)		→			→	
• Trykk på DISP/FUNC: skjermen viser "0-00"		→				
• Trykk på innstillingsknappene for å vise ønsket hastighet (fra 600 til 3000 rpm eller null)		→				
• For å gå videre til neste Timer, trykk på DISP/FUNC: skjermen viser "t2oFF". I eksempelet forblir denne Timeren deaktivert.		→				
• Trykk på DISP/FUNC for å gå til neste Timer og gjenta innstillingstrinnene (aktivering, Timer-klokkeslett og hastighet).		→		etc ...		
• Trykk på RUN/STOP for å gå ut og lagre. Visningen angir den aktuelle hastigheten eller StoP.		→				

5. VISUALISERING AV PARAMETRENE

Merk: Pumpen må få spenningstilførsel, være i gang utenfor aktiveringsfase, eller stanset.
 For å vise parametrene, trykk på tasten DISP/FUNC.
 Dersom det ikke blir trykket på en tast i løpet av 15 sek., går skjermen over til normal visning igjen (aktuell hastighet eller Stop).

<ul style="list-style-type: none"> Trykk på DISP/FUNC: skjermen viser "hr". Trykk igjen: visning av internt klokkeslett 	 → hr  → 11-45
<ul style="list-style-type: none"> Trykk på DISP/FUNC: skjermen viser "t0". Trykk igjen: visning av klokkeslettet for t0 (hastigheten til t0 er satt til 2400 rpm) 	 → t0  → 12-00
<ul style="list-style-type: none"> Trykk på DISP/FUNC: skjermen viser "t1". Trykk igjen: visning av klokkeslettet for denne Timer-sekvensen (tt-mm) 	 → t1  → 09-20
<ul style="list-style-type: none"> Trykk på DISP/FUNC: visning av hastigheten for denne Timer-sekvensen (i rpm) 	 → 1240
<ul style="list-style-type: none"> Trykk på DISP/FUNC etc. : visning av følgende Timer-sekvenser, klokkeslett og hastighet opp til Timer "t5" <p>Merk: De deaktiverte Timer-sekvensene vises ikke</p>	 → t2 etc ...
<ul style="list-style-type: none"> Trykk på DISP/FUNC: visning "P - - - - " Forbrukt styrke (i W, verdi ved +/-10%) <p>Merk: P = 0 W når pumpen er stanset</p>	 → P 634 / P 0
<ul style="list-style-type: none"> Trykk på DISP/FUNC: visning "h - - - - " Pumpens timeteller <p>Merk: En telleromdreining representerer 9999 timer</p>	 → h2857
<ul style="list-style-type: none"> Trykk på DISP/FUNC: visning "- - - - - " Totalt energiforbruk (i kWh) <p>Merk: En telleromdreining representerer 99999 kWh</p>	 → 06542
<ul style="list-style-type: none"> Trykk på DISP/FUNC: visning "- - - - - " Delvis energiforbruk (i kWh), siden siste nullstilling 	 → 00086
<ul style="list-style-type: none"> For å nullstille den delvise energitelleren: Trykk på en av knappene opp / ned i 3 sek. <p>Meldingen "CLEAR" angir at telleren er nullstilt;</p>	  → CLEAR <small>>3s</small>
<ul style="list-style-type: none"> Trykk på DISP/FUNC: Visning "SF On" eller "SFOFF" for aktivert / deaktivert Skimmer 	 → SF On / SFOFF
<ul style="list-style-type: none"> Trykk på DISP/FUNC: Visning "t - - " Styrkemodulens temperatur (i °C) 	 → t 74
<ul style="list-style-type: none"> Trykk på DISP/FUNC for å gå tilbake til normal visning (aktuell hastighet eller Stop) 	 → 1640 / Stop t2400 / :Stop

VEDLIKEHOLD

1. Koble pumpen helt fra nettstrømmen før du åpner lokket og rengjør forfilteret. Rengjør forfilterkurven regelmessig. Ikke slå på kurven for å rengjøre den. Sjekk pakningen på forfilterets lokk, og skift den ut om nødvendig.
2. Motorens akse er montert på selvsmørende rullelagre som ikke trenger senere smøring.
3. Hold motoren ren og tørr og pass på at det ikke finnes noen hindringer i lufteåpningene.
4. Den mekaniske ventilen kan ha en lekkasje og må da skiftes ut.
5. Med unntak for rengjøring av bassenget er det absolutt påkrevd at en godkjent Hayward®-representant eller en annen kvalifisert person utfører alle reparasjons- og vedlikeholdsoperasjoner.

Nedenstående sliddele på pumpen skal vedlikeholdes i henhold til deres forventede levetid:

Ansatt levetid for sliddele:

Saft mekanisk tætning	1 år
Motorlejersæt	1 år
Pakningsset (side, huset, skot, afløb)	2 år
Kondensator	2 år

VINTERTID

1. Tøm pumpen ved å fjerne alle tømmeproppene. Oppbevar disse i forfilterets kurv.
2. Koble fra pumpen, fjern slangekoblingene og oppbevar hele enheten på et tørt, godt luftet sted, eller ta i det minste følgende forholdsregel: Koble fra pumpen, fjern de fire festeboltene som fester pumpelegemet til motorens holder og oppbevar enheten på et tørt og godt luftet sted. Beskytt så pumpe- og forfilterlegemene ved å dekke dem til.

MERK: Før du setter pumpen i gang må du rengjøre alle de indre delene. Fjern støv, kalk osv.

MULIGE FEIL OG LØSNINGER

A) Motoren starter ikke

1. Kontroller de elektriske koblingene, bryterne eller releene, samt kortslutningene eller sikringene.
2. Sjekk manuelt at motoren roterer fritt.
3. Sjekk at rotasjonshastighetene V1, V2 og V3 ikke er programmert på 0 omdr./min. Er dette tilfellet, tilbakestill fabrikkparametrene (se § 4.4).
4. Dersom skjermen viser en av de følgende feilkodene, ta kontakt med installatøren din:

Err01	Underspenning på kontinuerlig linje	Err10	Internt strømtilførselsproblem
Err02	Overspenning på kontinuerlig linje	Err20	Mislykkede startforsøk
Err04	Overoppvarming av styrkemodul	Err64	Internt kortslutningsproblem
Err05	Overoppheting av motor	Err97	Mangeartet problem
Err07	Overintensitet	Err98	Kommunikasjonsproblem
		d5t0P	Se side 118

B) Motoren stanser, kontroller

1. Kabler, koblinger, releer osv.
2. Spenningsfall på motoren (som ofte forårsakes av svake kabler).
3. Det skal ikke forekomme fastheking eller overlast (ved avlesning av absorbert strømstyrke).

MERK: Pumpens motor er utstyrt med en termisk beskyttelse som ved overlast automatisk bryter kretsen og hindrer skade på motoren. Dette skjer ved unormale driftsforhold som må kontrolleres og korrigeres. Motoren starter igjen uten inngrep så snart de normale driftsforholdene er gjenopprettet.

C) "OLOAD" vises på displayet (problem med overlading eller overheting)

1. Kontroller at motorakselen dreier fritt
2. Sjekk at det ikke finnes smuss som hindrer turbinen i å rotere fritt
3. Kontroller at motoren er riktig ventilert
4. Løs problemet, og trykk på På/av-knappen

D) Pumpen suger ikke

1. Kontroller at forfilterets legeme er godt fylt med vann, at dekselets pakning er ren og riktig plassert og at det ikke er mulig å slippe inn luft. Trekk etter behov til dekselets sperreskruer.
2. Sørg for at alle suge- og utløpsventilene er åpne og ikke tilstoppet og at bassengets sugeåpninger er helt neddykket.
3. Sjekk at pumpen suger ved å frigjøre sugingen så nær pumpen som mulig:
 - a) hvis pumpen ikke suger tross tilstrekkelig påfylling av innsugingsvann
 1. Trekk til boltene og ekstrauststyret for slanger på innsugingssiden.
 2. Sjekk spenningen for å sikre at pumpen dreier med riktig hasitghet.
 3. Åpne pumpen og kontroller at ingenting stopper til på innsiden,
 4. Still inn tilstrekkelig høy aktiveringshastighet
 5. Rengjør filteret og prøv på nytt
 6. Skift ut den mekaniske ventilen.
 - b) Prøv aktivering i resirkuleringsmodus. Hvis pumpen suger normalt, må du sjekke sugeledningen og forfilteret som kan være tilstoppet eller medføre luftinntak.

F) Støy fra pumpen, sjekk

1. Hvis ingen inngående eller innsugende luft medfører stumpe knitringer i pumpen.
2. Hvis det ikke inntreer kavitasjon på grunn av utilstrekkelig diameter eller begrensning av sugeledningen. I tillegg kan en ledning som er overdimensjonert ved utløpet, føre til slik kavitasjon. Bruk riktige slanger eller tøm ledningene om nødvendig.
3. Hvis det ikke skjer vibrasjon grunnet feil montasje.
4. Hvis det ikke finnes noen fremmedlegemer i pumpelegemet.
5. Hvis motorens rullelagre ikke hektes fast på grunn av for stort spill, rust eller overheting i lengre tid.



HAYWARD®

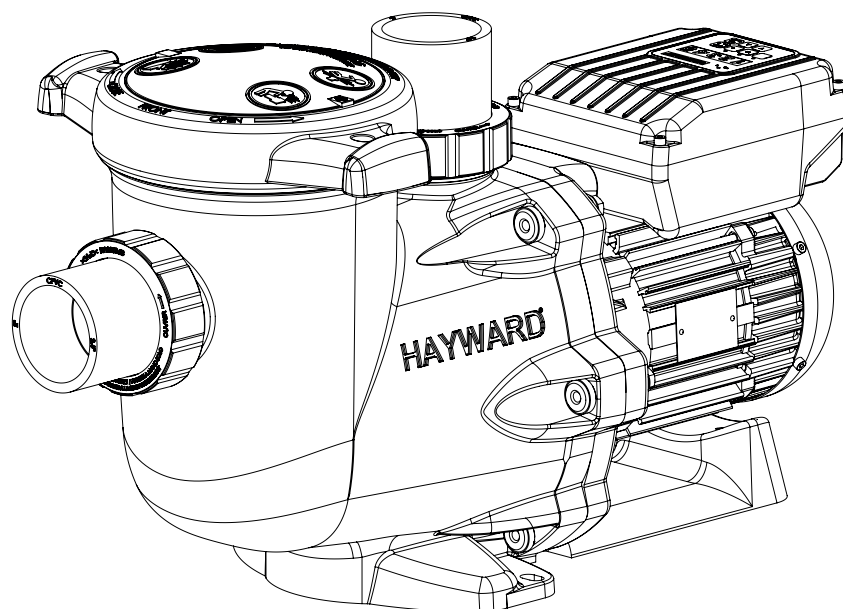

CENTRIFUGEPUMPE MED VARIABEL HASTIGHED

BRUGERVEJLEDNING

OPBEVAR DENNE MANUAL TIL SENERE BRUG



ADVARSEL: Elektrisk fare. Manglende overholdelse af instruktionerne kan resultere i alvorlig personskade eller død. TIL BRUG I SVØMMEBASSER

⚠ ADVARSEL – Før du åbner låget til filterrensning, skal du koble pumpen helt fra strømforsyningen.

⚠ ADVARSEL – Alle elektriske tilslutninger skal udføres af en kvalificeret autoriseret professionel elektriker og i overensstemmelse med de gældende regler i installationslandet, hvis dette ikke er tilfældet, den internationale standard IEC 60364-7-702.

⚠ ADVARSEL – Sørg for, at maskinen kun er tilsluttet en 230 V_~ stikkontakt, der er beskyttet mod kortslutning. Pumpen skal forsynes med strøm ved hjælp af en isolerende transformer eller via en Residual Current Device (RCD) med en nominel reststrøm, der ikke overstiger 30mA.

⚠ ADVARSEL – Sørg for, at børn ikke leger med dette apparat. Hold fingre og fremmedlegemer væk fra åbninger og bevægelige dele.

⚠ ADVARSEL – Motoren skal placeres på jorden ordentligt. Tilslut jordledningen til den grønne skrue på basen, og for kablede enheder skal du bruge den korrekte jordudgang.

⚠ ADVARSEL – Brug en motortilslutningssko til at forbinde motoren med andre tilslutningsdele ved hjælp af den korrekte størrelse leder som specificeret i elektriske koder.

⚠ ADVARSEL – Når du foretager sådanne elektriske forbindelser, skal du gennemgå diagrammet under motorens klemkassedæksel. Sørg for at kontrollere, at de elektriske forbindelser er tætte og forseglede, før du tilslutter strømmen. Fjern alle dæksler før brug.

⚠ ADVARSEL – Sørg for, at den elektriske forsyningsspænding, der kræves af motoren, svarer til distributionsnettet, og at de elektriske forsyningskabler svarer til pumpens effekt og strøm.

⚠ ADVARSEL – Læs og følg alle instruktioner indeholdt i denne brugervejledning og markeret på udstyret. Manglende overholdelse af instruktionerne kan forårsage legemsbeskadigelse. Dette dokument skal afleveres til poolejeren, som skal opbevare det et sikkert sted.

⚠ ADVARSEL – Børn over 8 år og personer uden den nødvendige viden eller erfaring eller med fysiske, mentale eller sensoriske handicap kan bruge dette apparat, hvis de har modtaget passende instruktioner og forstår farerne ved brugen. Børn må ikke lege med apparatet. Rengøring og brugervedligeholdelse må ikke udføres af børn, medmindre de er over 8 år og er under opsyn. Opbevar apparatet og ledningen utilgængeligt for børn under 8 år.

⚠ ADVARSEL – Pumpen er designet til kontinuerlig drift ved en maksimal vandtemperatur på 35°C.

⚠ ADVARSEL – Brug kun originale Hayward®-reservedele.

⚠ ADVARSEL – Hvis netledningen er beskadiget, skal den udskiftes af producenten, dennes forhandler eller lignende kvalificerede personer for at undgå farer.

⚠ ADVARSEL – En ekstern kontakt med alle-polet kontaktadskillelse, der giver fuldstændig afbrydelse under kategori III-overspændingsforhold, skal installeres i faste ledninger, der overholder ledningsreglerne for afbrydelse af strømforsyningen.

⚠ ADVARSEL – Brug ikke poolpumpen, hvis tilslutningskablet eller motortilslutningsboksens hus er beskadiget. Dette kan forårsage elektrisk stød. Et beskadiget strømkabel eller en motortilslutningsboks skal straks udskiftes af en tekniker eller tilsvarende kvalificeret person for at undgå fare.

⚠ ADVARSEL – Denne poolmotor er IKKE udstyret med et sikkerhedsvakuumudløsningssystem (SSLV). SSLV hjælper med at forhindre drukning fra kropsindfangning i nedsænkede afløb. I nogle poolkonfigurationer, hvis en persons krop dækker afløbet, kan personen blive fanget ved sugning.

Afhængigt af din poolkonfiguration kan en SSLV være påkrævet for at opfylde lokale kodekrav.

⚠ ADVARSEL – Denne pumpe indeholder et batteri, som af sikkerhedsmæssige årsager skal udføres af en kvalificeret teknisk service.

BRUG UDELUKKENDE ORIGINALE HAYWARD® RESERVEDELE

Tillykke! De har netop anskaffet Dem en Hayward® pumpe med variabel hastighed.

Pumper med variabel hastighed fra Hayward® er forsynet med en jævnstrømsmotor af den nyeste generation med permanent magnet. Denne motor styres af en mikroprocessor forbundet med en frekvensvariator; den har følgende tekniske funktioner:

- Visning af omdrejningshastighed på kontrolskærmen
- 3 foruddefinerede omdrejningshastigheder fra fabrikkens side (knapperne V1, V2, V3), hastighederne kan justeres af brugeren
- Systematisk spædning ved hver start, hastighed og spædningsvarighed kan indstilles
- Skimmerfunktion, fjernelse af urenheder fra vandoverfladen
- Programmerbar timerfunktion
- Visning af øjeblikkeligt strømforbrug
- Visning af samlet og delvist energiforbrug
- Visning af pumpens driftstid
- Lavt støjniveau
- Konstruktionsstandard TEFC IP55

Pumpen skal installeres i den korrekte afstand fra poolen, således at der er mindst mulig forbindelse mellem udsugning og pumpen, og tryktabet i det hydrauliske kredsløb begrænses mest muligt.

Ikke desto mindre er det strengt nødvendigt, at overholde den sikkerhedsafstand, er påbudt i henhold til de gældende normer (min. 3.5 m). Installer og brug af produktet i en højde på mindre end 2000 m.

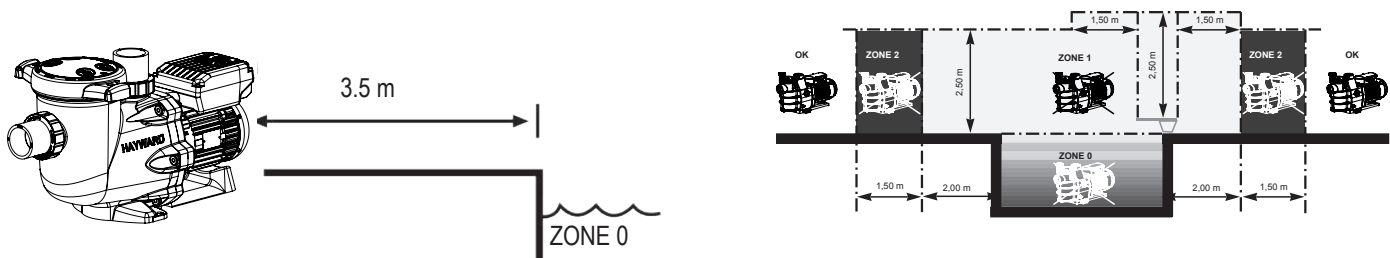

Installer pumpen i et tørt lokale med god ventilation, da motoren kræver, at luften kan cirkulere frit omkring den og skabe naturlig ventilation. Der skal være en friplads på 0,5 m omkring pumpen. Se jævnligt efter, at genstande, blade eller andet ikke kan komme til at hindre afkøling af motoren.

Pumpen skal installeres, således at den udvendige afbryder i den fastmonterede kapslingskasse er synlig og let tilgængelig. Afbryderen skal sidde i nærheden af pumpen.

Pumpen skal fast installeres med 8 mm skruebolte, på en betonsokkel. Disse skrues i betonen, der er forberedt med skruehuller. Der skal benyttes spændskiver for at undgå, at skrueboltene løsner sig med tiden. Hvis pumpen skal monteres på en træplade, skal der anvendes 8 mm træskruer med hexagonalt skruehoved og spændskiver for at undgå, at skrueerne løsner sig med tiden.

Pumpen skal installeres, så kapslingskassen ikke udsættes for voldsomme vandspøjt.

Hayward® pumpernes lydniveau er lavere end 70 dBA.

Påkrævede foranstaltninger:

- Pumpen skal tilsluttes jord: Pumpen må ikke køre, såfremt den ikke er tilsluttet jord.
- Pumpen skal tilsluttes med et kabel af typen H07RN-F 3G1,5mm².
- Der skal være en 30 mA differentialsikring, til beskyttelse af personer mod elektrisk stød forårsaget af eventuelt brud på isoleringen af det elektriske udstyr.
- Der skal være sikring mod kortslutning (størrelsen defineres i forhold til den øvre værdi, der fremgår af maskinpladen).
- Der skal være en afbryder til forsyningsnettet, hvis åbningsafstand på alle polkontakter sikrer en fuldstændig afbrydelse i tilfælde af overspændingskategori III.

⚠ OBS: Vent i 5 minutter efter at strømmen til pumpen er helt afbrudt før der arbejdes på motoren eller kapslingskassen: **Fare for elektrisk stød - dette kan have døden til følge.**

Elmotorerne på vores pumper er forsynet med temperaturbeskyttelse, som reagerer ved overspænding eller unormal opvedning af motoren. Denne beskyttelse slår automatisk til igen, når temperaturen i spolen falder.

Hvis det er et regelkrav og uanset motortype, skal der ud over de nedennævnte anordninger, installeres en termomagnetisk sikring, som skal kalibreres i henhold til anvisningerne på motorpladen.

Tabellen på side 169 viser specifikationerne på de forskellige pumper på vores udstyr.

EI-installation: Kontroller at den forsyningsspænding, som motoren skal bruge, svarer til forsyningsnettets, og at kablets tykkelse og længde svarer til pumpens spænding og strømstyrke.

Hele installationen af pumpen såvel som eventuel udskiftning af kabler skal foretages af en autoriseret elinstallatør for at udelukke alle faresituationer.

Ved alle elektriske installationer skal alle henvisninger under tilslutningstavlerne overholdes.

Efterse omhyggeligt, at de elektriske forbindelser er godt tilspændt og tætte før strømme slutes.

Det er vigtigt, at kablet føres gennem de rette åbninger og ferritisoleringer. Pakdåsen sikrer, at der er tæt omkring kablet, og ferritten er et filter mod elektromagnetiske forstyrrelser.

Nogle af vore pumper er forsynet med en forkabling. Denne skal fjernes, når pumpen blivende tilsluttes strømforsyningen. Egentlig anvendes denne forkabling kun til test i fabrikken under forskellige produktionsfaser.

MONTERING

Poolpumpen skal monteres, således at der er mindst muligt spændingstab, samtidig med overholdelsen af afstandskravet på mindst 3,5 m mellem pumpen og poolen. Udsugningsledningen skal installeres, således at der er en svag stigning hen mod pumpens akse. Det er vigtigt, at samlinger er godt tilspændt og tætte. Imidlertid må rør og slanger ikke spændes alt for hårdt. Når det drejer sig om plastmaterialer, må der kun tættes med teflon. Sugelangen skal have en diameter, der er større end eller mindst lig med afløbsslangen. Undgå placeringer på uventilerede eller fugtige steder. Af hensyn til motoren, skal køleluften kunne cirkulere frit. Pumpen skal installeres, så kapslingskassen ikke udsættes for voldsomme vandspøjt.

VIGTIGT: Tjek motorens omdrejningsretning før den tilsluttes endeligt.

INSTRUKTIONER TIL IDRIFTSTAGNING OG START: Fyld vand i forfilterbeholderen op til sugelangen. Pumpen må ikke køre uden vand, da vandet er nødvendigt for afkøling og smøring af den mekaniske ventil. Åbn alle ventiler på henholdsvis sugeslanger og afløbsslanger, samt på filtrets udluftningsventil, hvis en sådan findes. (Der må absolut ikke være luft i sugeslangerne). Start enheden og vent et stykke tid, før motoren primes. Det kan nemt tage 5 minutter, før primingen er gennemført (denne priming afhænger af sugehøjden og længden af sugelangen). Hvis pumpen ikke starter eller ikke tænder, henvises De til at søge hjælp i fejlfindervejledningen.

BRUG AF BETJENINGSBOKSEN

1. PRÆSENTATION

Hayward® pumpen med variabel hastighed styres af en betjeningsboks, der giver mulighed for at vise driftsparametrene, at indstille dem og at programmere timertilstanden.

1	Lysdiode for tændt
2	LCD displayskærm
3	Valg af hastighed
4	Skift mellem manuel tilstand og timertilstand
5	Op/ned-indstillingsknapper
6	Knap for tænd/sluk
7	Knap til visning af parametre
8	Lysdioder for valgt hastighed

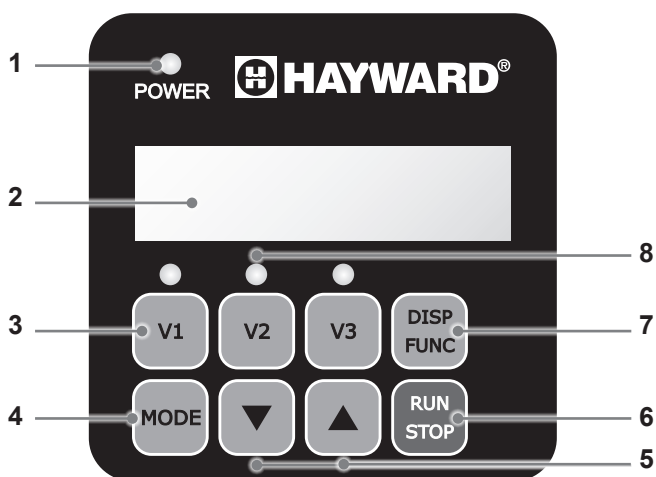

Pumpen leveres med **STANDARDPARAMETRE** (fabriksindstillinger):

Spædning varighed (sek.)	Spædning hastighed (omdr./min.)	V1 (omdr./min.)	V2 (omdr./min.)	V3 (omdr./min.)	Skimmer varighed (min.)	Skimmer cyklus (t)	Skimmer hastighed (omdr./min.)
240	3000	1500	2400	3000	15	1t	2800

omdr./min.: Omdrejninger pr. minut

BRUG UDELUKKENDE ORIGINALE HAYWARD® RESERVEDELE

2. PUMPENS FUNKTIONSTILSTANDE

2.1 Manuel tilstand

I manuel tilstand starter eller stopper brugeren pumpen manuelt i forhold til brugen af svømmepølen.

- Start af pumpen igangsætter en spædningsfase (a). Denne fase kan reguleres (hastighed, varighed § 4.2). Spædningen kan afbrydes ved starten (§ 3.2) eller deaktiveres via indstillingerne.
- Pumpens hastighed stabiliserer sig herefter på en konstant værdi (b) (som standard stabilisering af hastighed V2). Denne hastighed kan vælges og justeres af brugeren (§ 3.3).
- Efter stop/genstart vil pumpen stabilisere sig på den sidst gemte hastighed.

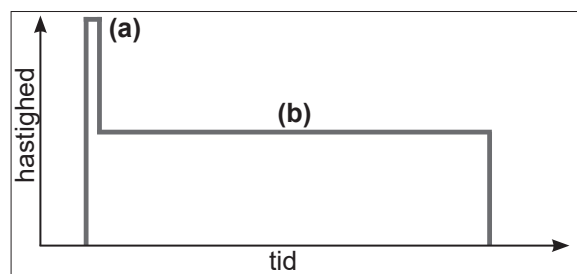

2.2 Skimmer

Med skimmerfunktionen kan man fjerne urenheder fra vandoverfladen, især for at undgå akkumulering og stagnation af urenheder på svømmepølens vandoverflade.

- Denne funktion er automatisk: Pumpen fungerer ved en højere hastighed (c) i en given varighed og ifølge en indstillelig cyklus.
- Bortset fra denne stigning i hastigheden genfinder pumpen sin normale hastighed, uanset om det er i manuel tilstand eller timertilstand.
- Funktionen Skimmer kan deaktiveres (se indstillinger § 4.3).

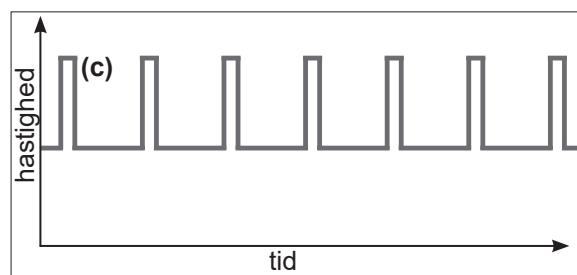

2.3 Timertilstand

I timertilstand er pumpens drift automatiseret i 24/24. De forskellige hastighedssekvenser (d) skal programmeres af brugeren. De vælges i forhold til installationen (varmetilstand, energibesparelse osv.) og tidspunkterne, hvor svømmepølen bruges.

- Hvis skimmerfunktionen er aktiveret, har den prioritet over disse sekvenser.
- Pumpen kan standses (sættes på pause) i timertilstand. Ved genstarten vil hastigheden være den, der gælder for igangværende timer.
- Se § 4.5 for programmering af timertilstanden.

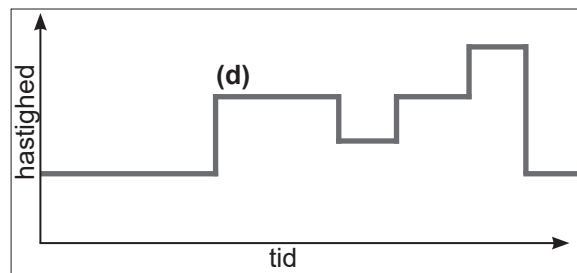

2.4 Skift mellem manuel tilstand og timertilstand

Man skifter tilstand ved at trykke på knappen , som vist herunder:

Manuel tilstand

Visning af hastighed uden præfiks



Den tændte lysdiode angiver den valgte hastighed (V2 som standard)

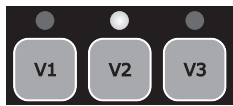

Timertilstand

Visning af hastighed med præfikset "t"

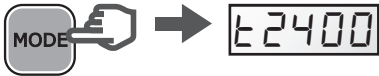

Lysdioderne er slukket

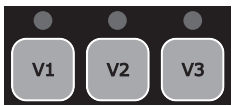

2.5 Tilslutning af de digitale indgange

⚠️ Vigtigt. Før et elektrisk arbejde på pumpen, afbryd strømforsyningen og vent 5 min.

Filtreringspumpen er forsynet med et kabel med 5 tråde af en længde på 3 m for tilslutning af 4 digitale indgange eller relæer (Åben/Lukket).

Eksempler på brug af de digitale indgange

- Tildel den hastighed og kapacitet som er nødvendige for velfungerende perifere enheder, såsom en varmepumpe, en rulleskodde eller en sugerobot, osv ...
- Installer en kommandolinie fra brugergrænsefladen. Disse digitale indgange anvendes til at styre Run/Stop-funktionen og de 3 hastigheder (V1-V2-V3) i en afstand på 3m.

Tildeling af tråde		
DI1	Brun	Hastighed V1
DI2	Grøn	Hastighed V2
DI3	Hvid	Hastighed V3
DI4	Rød	Run/Stop
C	Sort	Fælles

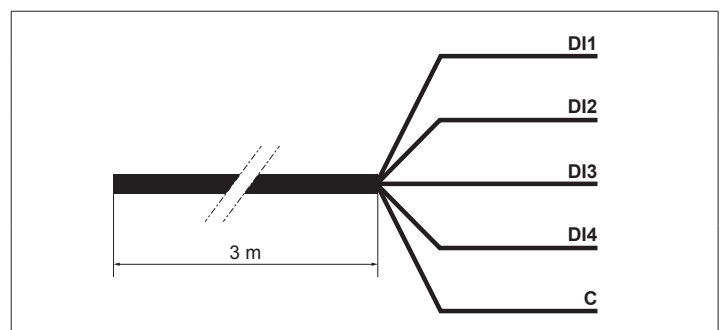

Bemærk :

- I tilfælde af delvis anvendelse af de digitale indgange isoleres de ubrugte elektriske tråde.
- I tilfælde af manglende brug af digitale indgange, indsættes stikket (A) i stedet for 5-trådeskablet (se figur nedenfor).

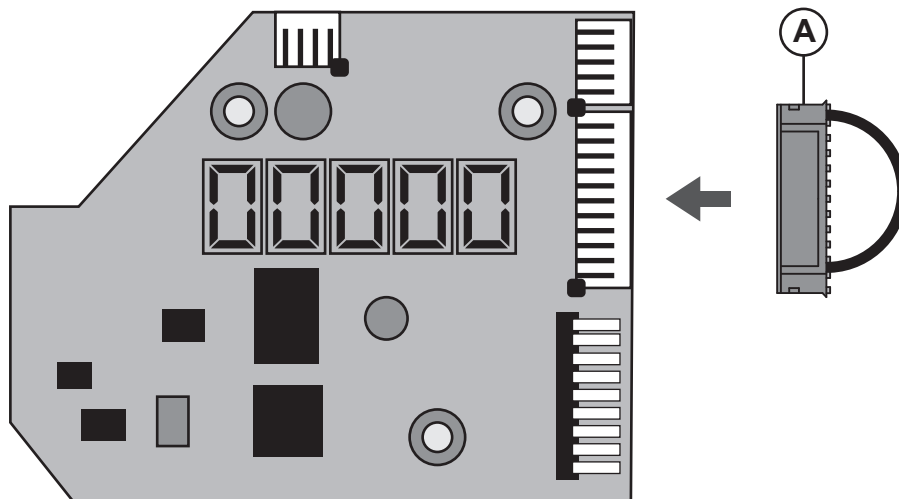

BRUG UDELUKKENDE ORIGINALE HAYWARD® RESERVEDELE

Drift med digitale indgange

<p>De digitale indgange kan bruges i manuel eller timer-tilstand. De har den højeste prioritet, de er MASTER for alle funktioner i brug. Kun knapperne Run/Stop og DISP/FUNC forbliver aktive.</p>	→	
	→	
<p>Når en digital indgang anvendes, blinker den pågældende LED forbundet med den tilsvarende hastighed hurtigt (DI1 = V1, DI2 = V2 eller DI3 = V3).</p>	→	

<p>For at opnå en handling via de digitale indgange, skal indgangen DI4 være lukket.</p>	→	DI4 Run/StopLukket		
<p>Hvis flere digitale indgange er tændt samtidigt, vil kun én udføres i prioriteret rækkefølge, som er defineret i nedenstående tabel.</p>		DI1 = V1	DI2 = V2	DI3 = V3
	DI1 = V1	V1	V2	V3
	DI2 = V2	V2	V2	V3
	DI3 = V3	V3	V2	V3



Bemærk : Når handlingen, som en gang er forbundet med den digitale indgang er færdig (kontakt åben), genoptager filtreringspumpen handlingen for den igangværende driftstilstand.

<p>Hvis den digitale indgang D14 er åben, starter filtreringspumpen ikke, og dSTOP vises på pumpens skærm.</p> <ul style="list-style-type: none"> • Luk indgangen D14. • Tryk eventuelt på RUN/STOP for at starte filtreringspumpen. 	→	
	→	<p>eller</p>
	→	

3. BRUG







3.1 Tænding

Kontrollampen "Power" tænder; skærmen udfører en LCD-test, derefter vises softwareversionen



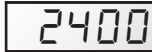
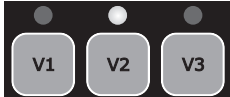



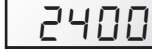
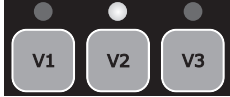

→

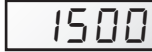
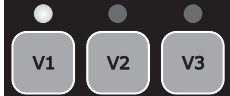
→

3.2 Spændingsfase

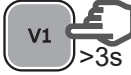
Når der er blevet tændt for pumpen, starter spændingsfasen automatisk (det samme gælder efter en genstart af pumpen).





<p>Automatisk igangsætning af spændingsfasen:</p> <ul style="list-style-type: none"> Hastigheden stiger op til 3.000 omdr./min. og fastholdes i 240 sek. (standardværdier) 		→		
<p>Afslutning på spændingsfasen:</p> <ul style="list-style-type: none"> Hastigheden stabiliserer sig som standard på V2 eller på den sidst gemte hastighed Den tilhørende lysdiode tænder (manuel tilstand) 		→		
<p>For at få vist den resterende spændingstid:</p> <ul style="list-style-type: none"> Tryk på DISP/FUNC Den resterende tid vises i sek. 		→		
<p>For at afslutte før afslutningen af spændingsfasen:</p> <ul style="list-style-type: none"> Tryk på RUN/STOP Hastigheden stabiliserer sig som standard på V2, eller på den sidst gemte hastighed 		→		

3.3 I manuel tilstand: Valg, indstilling og lagring af en hastighed

<p>Sådan vælges en hastighed:</p> <ul style="list-style-type: none"> Tryk på en af hastighedsknapperne Standardværdien vises (i omdr./min.) Den tilhørende lysdiode tænder 		→		
<p>Sådan indstilles en ny hastighedsværdi:</p> <ul style="list-style-type: none"> Tryk på op/ned-indstillingsknapperne Lysdioden blinker: Indstilling er i gang Indstil den ønskede værdi (fra 600 til 3.000 omdr./min.) 		→		
<p>Sådan gemmes den nye hastighedsværdi:</p> <ul style="list-style-type: none"> Tryk i 3 sekunder på hastighedsknappen Lysdioden lyser konstant, når hastigheden er gemt 		→		

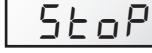
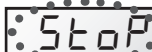
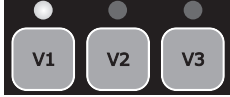
Bemærkning: Den vandmængde, der fremkommer via pumpens hastighed, skal være tilpasset efter installationens kapacitet (filter, rørføringer...). Kontakt en faglært, hvis der opstår tvivl.

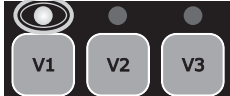











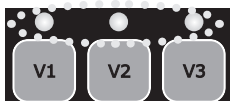

3.4 Stop/genstart af pumpen

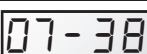
<p>Sådan stoppes pumpen:</p> <ul style="list-style-type: none"> Tryk på RUN/STOP Pumpe stopper, lysdiode for hastighed forbliver tændt I manuel tilstand viser skærmen "StoP" uden at blinke I timertilstand viser skærmen "StoP", der blinker 		→	 	
<p>Sådan genstartes pumpen:</p> <ul style="list-style-type: none"> Tryk på RUN/STOP Pumpen starter med spændingsfasen (§ 3.2) Hastigheden stabiliserer sig: I manuel tilstand på den sidst kendte værdi; i timertilstand på værdien, der gælder for den aktuelle timer 		→		
		→		

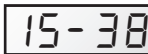











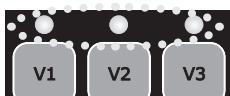

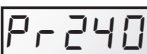





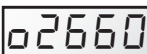

4. INDSTILLINGER

Bemærkning: For at få adgang til indstillingerne skal pumpen være tændt og i **manuel tilstand** (§ 2.4), stoppet eller i gang uden for spædningsfasen.
Hvis der ikke trykkes på nogen knap i 2 minutter, vender normal visning tilbage (hastighed eller stoP), og indstillingerne bliver ikke gemt.

4.1 Indstilling af uret

<ul style="list-style-type: none"> • Tryk i 3 sekunder på DISP/FUNC De tre lysdioder blinker • Skærmen viser "ConF" derefter "hr" 						
<ul style="list-style-type: none"> • Tryk på DISP/FUNC, skærmen viser klokken på det interne ur (tt-min.) 						
<ul style="list-style-type: none"> • Tryk på op/ned- indstillingsknapperne for at indstille timer/minutter 						
<ul style="list-style-type: none"> • Tryk på RUN/STOP for at afslutte og gemme Visningen angiver den aktuelle hastighed eller StoP 						
<p>Bemærkning: Det er vigtigt at indstille det interne ur, hvis pumpe kører i timertilstand. Indstillingen af uret gemmes, når der slukkes for pumpen.</p>						

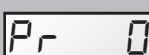
4.2 Indstilling af spædning

<ul style="list-style-type: none"> • Tryk i 3 sekunder på DISP/FUNC De tre lysdioder blinker, og skærmen viser "ConF" 					
<ul style="list-style-type: none"> • Tryk på DISP/FUNC n antal gange, indtil skærmen "Pr 240" kommer frem med standard varighed af spædningen (sek.) 					
<ul style="list-style-type: none"> • Tryk på op/ned-indstillingsknapperne for at få vist den ønskede varighed (fra 0 til 300 sek.) 					
<ul style="list-style-type: none"> • Tryk på DISP/FUNC: Skærmen viser "o3000" spædningshastighed som standard (omdr./min.) 					
<ul style="list-style-type: none"> • Tryk på op/ned-indstillingsknapperne for at få vist den ønskede værdi (maks. 3.000 omdr./min.) 					
<ul style="list-style-type: none"> • Tryk på RUN/STOP for at afslutte og gemme Visningen angiver den aktuelle hastighed eller StoP 					
<p>Bemærkning: Hvis spædningsvarigheden er 0, vil visningen være "ProFF": Spædningen er deaktiveret</p>					

4.3 Indstilling af skimmerfunktion

Se § 2.2 for beskrivelse af denne funktion

<ul style="list-style-type: none"> Tryk i 3 sekunder på DISP/FUNC De tre lysdioder blinker, og skærmen viser "ConF" 		→	ConF	
<ul style="list-style-type: none"> Tryk på DISP/FUNC n antal gange, indtil skærmen "SFO.15" kommer frem: Standard aktiveringsvarigheden for skimmer (i minutter) 		→	SFO.15	
<ul style="list-style-type: none"> Tryk på op/ned-indstillingsknapperne for at få vist den ønskede varighed (fra 0 til 30 min.) 		→	SFO20	
<ul style="list-style-type: none"> Tryk på DISP/FUNC: Skærmen viser "St 1h": Standardvarighed for skimmercyklus 		→	St 1h	
<ul style="list-style-type: none"> Tryk på indstillingsknapperne for at indstille skimmercyklussen til 1 t, 2 t eller 3 t 		→	St 2h	
<ul style="list-style-type: none"> Tryk på DISP/FUNC: Skærmen viser "S2800": Standardhastighed for skimmer (omdr./min.) 		→	S2800	
<ul style="list-style-type: none"> Tryk på op/ned-indstillingsknapperne for at vise til den ønskede hastighed (fra 600 til 3000 omdr./min.) 		→	S2680	
<ul style="list-style-type: none"> Tryk på RUN/STOP for at afslutte og gemme Visningen angiver den aktuelle hastighed eller StoP 		→	1640 / StoP	
Bemærkning: Skimmer deaktiveres ved at sætte dens varighed til nul - Visningen bliver "SFoFF"		→	SFO00 → SFoFF	

4.4 Nulstilling af parametrene

For at gendanne parametrene standardindstilling og slette indstillingerne for timertilstand skal man gå frem på følgende måde:

<ul style="list-style-type: none"> Tryk i 3 sekunder på DISP/FUNC De tre lysdioder blinker, og skærmen viser "ConF" 		→	ConF	
<ul style="list-style-type: none"> Tryk på DISP/FUNC n antal gange, indtil meddelelsen "Init" vises på skærmen 		→	Init	
<ul style="list-style-type: none"> Tryk på indstillingsknappen "haut" i 3 sek. Visningen skifter til "donE", når nulstillingen er udført 		→	donE → StoP	

Husk: Standardparametre og indstillingsområder

	Spædning		Hastighedsknapper			Skimmerfunktion			Timerfunktion			
	Pr	o _ _ _	V1	V2	V3	SF	St	S _ _ _	t0	t1	t5	
Enhed	sek.	omdr./min.	omdr./min.	omdr./min.	omdr./min.	min.	t	omdr./min.	tt-min	omdr./min.	tt-min	omdr./min.
Som standard	240	3000	1500	2400	3000	15	1	2800	06-00	2400	oFF	0
Mini	0 (oFF)	600	600	600	600	0 (oFF)	1 ...	600	00-00	—	00-00	0/ 600
Maxi	300	3000	3000	3000	3000	30	... 3	3000	24-00	—	24-00	3000

BRUG UDELUKKENDE ORIGINALE HAYWARD® RESERVEDELE

4.5 Programmering af timertilstand

Betjeningsboksen giver mulighed for at programmere flere sekvenser (se § 2.3) eller timere, t0 til t5, som ikke nødvendigvis behøver at være i kronologisk rækkefølge.

De ikke anvendte timere bliver deaktiveret.

Timer "t0" kan fastsættes til 00:00, 06:00 (standard); 12:00 eller 18:00.

Den kan ikke deaktiveres.

Hastigheden for segment t0 kan ikke justeres, den er fastsat til 2.400 omdr./min

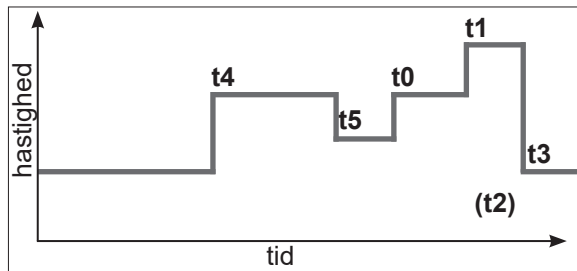

















- Man kan lave en grafik af den hastighedsprofil, som man ønsker at programmere. Grafikken her ved siden af er givet som et eksempel.
- Kontrollér, at det interne ur er korrekt til indstillet.

<ul style="list-style-type: none"> • Tryk i 3 sekunder på DISP/FUNC De tre lysdioder blinker, og skærmen viser "ConF" 		→	ConF			
<ul style="list-style-type: none"> • Tryk på DISP/FUNC 2 gange, indtil visningen "t0" kommer frem 		→	t0			
<ul style="list-style-type: none"> • Tryk på DISP/FUNC, skærmen viser "06-00": Standardværdi for t0 		→	06-00			
<ul style="list-style-type: none"> • Tryk på indstillingsknapperne for at fastsætte den ønskede t0 (00-00, 06-00, 12-00 eller 18-00) 		→	18-00			
<ul style="list-style-type: none"> • Tryk på DISP/FUNC: Skærmen viser "t1oFF" 		→	t1oFF			
<ul style="list-style-type: none"> • For at aktivere denne timer (eksempel), skal man trykke på knappen "haut". Skærmen viser "t1 on" 		→	t1 on			
<ul style="list-style-type: none"> • Tryk på DISP/FUNC: Skærmen viser "00-00" 		→	00-00			
<ul style="list-style-type: none"> • Tryk på op/ned-indstillingsknapperne for at indstille tidspunkterne (tt-mm) 		→	20-00		→	20-15
<ul style="list-style-type: none"> • Tryk på DISP/FUNC: Skærmen viser "0" 		→	0			
<ul style="list-style-type: none"> • Tryk på indstillingsknapperne for at vise den ønskede hastighed (fra 600 til 3.000 omdr./min. eller nul) 		→	2740			
<ul style="list-style-type: none"> • For at gå til efterfølgende timer skal man trykke på DISP/FUNC: Skærmen viser "t2off". I dette eksempel forbliver denne timer deaktiveret 		→	t2off			
<ul style="list-style-type: none"> • Tryk på DISP/FUNC for at gå til efterfølgende timer og gentage indstillingsetaperne (aktivering, tidspunkter for timer og hastighed) 		→	t3off etc ...			
<ul style="list-style-type: none"> • Tryk på RUN/STOP for at afslutte og gemme Visningen angiver den aktuelle hastighed eller StoP 		→	1640 / StoP			

BRUG UDELUKKENDE ORIGINALE HAYWARD® RESERVEDELE

1. VISNING AF PARAMETRE

Bemærkning: Pumpen skal være tændt, i gang uden for spædningsfasen eller stoppet.
 Tryk på tasten DISP/FUNC for at bladre gennem parametrene.
 Hvis der ikke trykkes på nogen tast i 15 sek. vender skærmen tilbage til normal visning (aktuel hastighed eller Stop).

<ul style="list-style-type: none"> Tryk på DISP/FUNC: Skærmen viser "hr" Tryk igen: Visning af internt ur 	 → hr  → 11-45
<ul style="list-style-type: none"> Tryk på DISP/FUNC: Skærmen viser "t0" Tryk igen: Visning af tider for t0 (hastigheden for t0 er fastlagt til 2.400 omdr./min.) 	 → t0  → 12-00
<ul style="list-style-type: none"> Tryk på DISP/FUNC: Skærmen viser "t1" Tryk igen: Visning af tidspunkt for denne timer (tt-mm) 	 → t1  → 09-20
<ul style="list-style-type: none"> Tryk på DISP/FUNC: Visning af hastighed for denne timer (i omdr./min.) 	 → 1240
<ul style="list-style-type: none"> Tryk på DISP/FUNC osv.: Visning af efterfølgende timere, tidspunkter og hastighed, indtil timer "t5" Bemærkning: De deaktiverede timere vises ikke 	 → t2 etc ...
<ul style="list-style-type: none"> Tryk på DISP/FUNC: Visning af "P - - - -" Strømforbrug (i W, værdi til +/- 10 %) Bemærkning: P = 0 W når pumpen er stoppet 	 → P 634 / P 0
<ul style="list-style-type: none"> Tryk på DISP/FUNC: Visning af "h - - - -" Pumpens timetæller Bemærkning: En omdrejning af tælleren repræsenterer 9999 t 	 → h2857
<ul style="list-style-type: none"> Tryk på DISP/FUNC: Visning af "- - - - -" Samlet energiforbrug (i kWt) Bemærkning: En omdrejning af tælleren repræsenterer 99999 kWt 	 → 06542
<ul style="list-style-type: none"> Tryk på DISP/FUNC: Visning af "- - - - -" Delvist energiforbrug (i kWh), siden sidste nulstilling 	 → 00086
<ul style="list-style-type: none"> Sådan nulstilles den delvise energiforbrugstæller: Tryk i 3 sek. på en af op/ned-knapperne. Meddelelsen "CLEAR" angiver, at tælleren er blevet nulstillet 	  → CLEAR <small>>3s</small>
<ul style="list-style-type: none"> Tryk på DISP/FUNC: Visning af "SF On" eller "SFOFF" for skimmer aktiveret/deaktiveret 	 → SF On / SFOFF
<ul style="list-style-type: none"> Tryk på DISP/FUNC: Visning af "t - -" El-modulets temperatur (i °C) 	 → t 74
<ul style="list-style-type: none"> Tryk på DISP/FUNC for at vende tilbage til normal visning (aktuel hastighed eller Stop) 	 → 1640 / Stop t2400 / Stop

VEDLIGEHOLDELSE

1. Pumpen skal fuldstændigt afbrydes fra strømforsyningen, før dækslet må åbnes for rengøring af forfiltret. Rens forfilterets kurv med jævne mellemrum og undlad at banke på kurven for at rengøre den. Efterse dækslet på forfiltret og skift det ud, hvis påkrævet.
2. Motorens aksel er monteret på selvsmørende lejer, som ikke kræver yderligere smøring.
3. Hold motoren ren og tør og sørg for, at der ikke er fremmedelementer i ventilationsåbningerne.
4. Fra tid til anden kan der komme en læk i den mekaniske ventil, hvorefter den skal udskiftes.
5. Bortset fra rengøringen af poolen, skal alt reparations- og vedligeholdelsesarbejde udføres af en person, der er autoriseret af Hayward® eller af en med relevante faglige kvalifikationer.

Slitedeler på pumpen nevnt nedenfor bør vedlikeholdes i henhold til deres estimerede levetid:

Ansatt levetid for slitsdeler:

Soft mekanisk tetning	1 år
Motorlagersætt	1 år
Set med pakning (sil, huset, skot, avløp)	2 år
Kapasitor	2 år

VINTERKLARGØRING

1. Pumpen skal tømmes ved at fjerne bundpropperne og lægge dem i forfilterkurven.
2. Pumpens tilslutning skal afbrydes, slangekoblinger skal tages af og opbevares samlet på et tørt og velventileret sted, eller - i det mindste - skal følgende forholdsregler tages: pumpens tilslutning afbrydes, de bolte, der fastholder pumpehuset til motorchassiet fjernes og det hele opbevares på et tørt og velventileret sted. Derefter skal selve pumpen og forfiltret dækkes over.

OBS: Før pumpen tages i brug igen, skal alle indvendige dele rengøres, støv og kedelsten fjernes, osv.

MULIGE FEJLKILDER OG LØSNINGER

A) Motoren starter ikke

1. Tjek alle elektriske installationer, afbrydere og relæer samt kortslutningssikringer og andre sikringer.
2. Tjek manuelt, at motoren kan rotere uhindret.
3. Kontroller om omdrejningshastighederne V1, V2 og V3 er programmeret til 0 o/min. Hvis dette er tilfældet foretag da en re-initialisering af fabriksindstillingerne (se § 4.4).
4. Hvis skærmen viser en af fejlkoderne i det følgende, skal man kontakte installatøren:

Err01	Underspænding af ensrettet linje	Err10	Internt el-forsyningsproblem
Err02	Overspænding af ensrettet linje	Err20	Startforsøg mislykket
Err04	Ophedning af el-modul	Err64	Internt kortslutningsproblem
Err05	Ophedning af motor	Err97	Flere problemer
Err07	Over-intensitet	Err98	Kommunikationsproblem
		dstoP	Se side 132

B) Motoren går i stå, tjek

1. Kabler, forbindelser, relæer osv.
2. Der er spændingsfald i motoren (skyldes ofte, at kablerne er for spinkle).
3. Der er ingen friktion eller overspænding (målt som ladestrøm).

OBS: Deres pumpemotor er udstyret med en temperaturbeskyttelse som i tilfælde af overspænding automatisk afbryder kredsløbet og forhindrer at motoren lider overlast. Denne udløsning forårsages af unormale driftsforhold, som skal undersøges og korrigeres. Motoren starter uden videre så snart driftsforholdene atter er normale.

C) «OLOAD» vises på skærmen (overbelastnings- eller overophedningsproblem)

1. Undersøg om drivakslen kan rotere uhindret
2. Undersøg om evt. snavs hindrer turbinens frie rotation
3. Undersøg om motoren er tilstrækkeligt ventileret
4. Når problemet er afhjulpet, trykkes på start/stop knappen

D) Pumpen starter ikke op

1. Se efter, om forfilterhuset er fyldt med vand, om dækslets lukkesystemer er rent og det er placeret korrekt, så der ikke kan trænge luft ind overhovedet. Hvis det er nødvendigt, skal låget spændes hårdere.
2. Se efter, om alle udsugnings- og afløbsventiler er åbne og at de ikke er stoppede, samt at alle poolens udsugningsåbninger befinder sig fuldstændig under vand.
3. Undersøg om pumpen suger og slipper udsugningen så tæt som muligt ved pumpen:
 - a) hvis pumpen ikke suger på trods af, at der har været fyldt tilstrækkeligt vand på fra starten
 1. Spænd bolte og ekstra slanger på sugesiden.
 2. Kontroller spændingen for at sikre, at pumpen roterer ved den rette hastighed.
 3. Åbn pumpen og undersøg, om der er noget der blokerer indvendigt.
 4. Indstil en tilstrækkelig spædningshastighed
 5. Få filteret rensset, og prøv igen
 6. Udskift den mekaniske ventil.
 - b) Forsøg en spædning i recirkulationstilstand. Hvis pumpen suger normalt, skal sugeslangen og forfiltret efterses, da de kan være tilstoppede og derfor tage luft ind.

E) Pumpen støjer, tjek

1. Om der kommer luft ind i eller der er luft i udsugningen, som forårsager lyde i pumpen.
2. Om der er hulninger, der skyldes at diameteren er for lille eller at der er en forsnævring i sugeslangerne. Tilsvarende vil en sugeslange, der er overdimensioneret i forhold til afløbet, også danne en sådan hulning. Brug de rette slanger eller rens rørene hvis påkrævet.
3. Om der er vibrationer, der skyldes forkert montering.
4. Om der er et fremmedlegeme inde i pumpen.
5. Om motorens mangler friktion til motorlejerne der skyldes for stort spil, rust eller overophedning over længere tid.



HAYWARD®

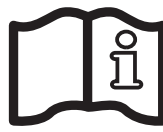
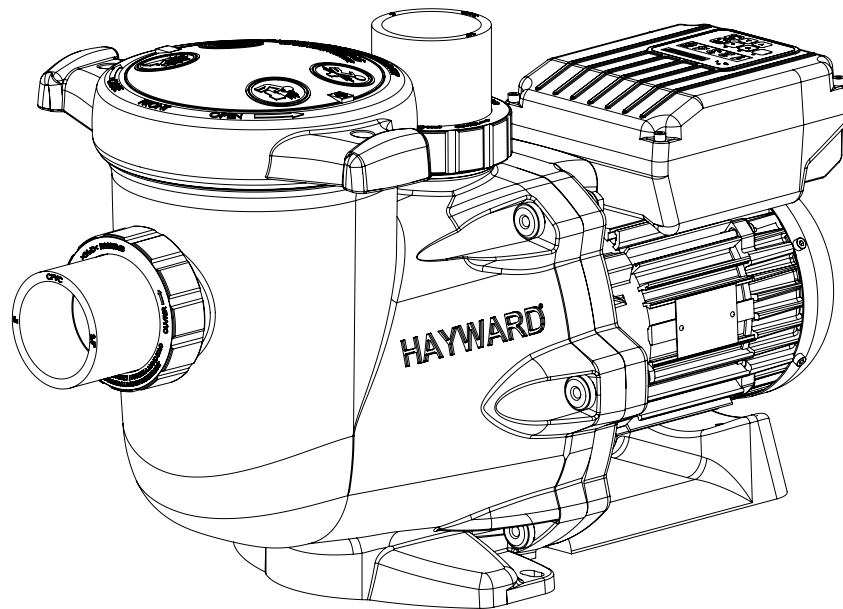

KESKIPAKOPUMPPU SÄADETTÄVÄLLÄ NOPEUDELLA KÄYTTÖOHJE

SÄILYTÄ TÄMÄ KÄYTTÖOHJE MYÖHEMPÄÄ TARVETTA VARTEN



HUOMIO: Sähköiskun vaara. Ohjeiden noudattamatta jättäminen voi johtaa vakavaan loukkaantumiseen tai kuolemaan. KÄYTTÖÖN UIMA-ALLASSA

⚠ HUOMIO – Ennen kuin avaat kannen suodattimen puhdistusta varten, irrota pumppu kokonaan sähköverkosta.

⚠ HUOMIO – Kaikki sähköliitännät on tehtävä pätevän valtuutetun sähköasentajan toimesta asennusmaan voimassa olevien määräysten mukaisesti, jos näin ei ole, kansainvälisen standardin IEC 60364-7-702 mukaisesti.

⚠ HUOMIO – Varmista, että kone on kytketty vain 230 V_~ pistorasiaan, joka on suojattu oikosululta. Pumppu saa virtansa erotusmuuntajasta tai jäännösvirtalaitteen (RCD) kautta, jonka nimellisvikäkäyttövirta on enintään 30 mA.

⚠ HUOMIO – Varmista, etteivät lapset leiki tällä laitteella. Pidä sormet ja vieraat esineet poissa aukoista ja liikkuvista osista.

⚠ HUOMIO – Moottori on asetettava maahan asianmukaisesti. Liitä maadoitusjohto pohjassa olevaan vihreään ruuviin ja käytä langallisissa laitteissa asianmukaista maadoituspistorasiaa.

⚠ HUOMIO – Käytä moottorin liitännäkorkvaa moottorin liittämiseen muihin liitännäosiin käyttämällä oikeankokoista johdinta sähkömääräysten mukaisesti.

⚠ HUOMIO – Kun teet tällaisia sähköliitännöitä, katso moottorin liitännäkotelon kannen alla oleva kaavio. Varmista, että sähköliitännät ovat tiukat ja tiiviit, ennen kuin liität verkkovirtaan. Poista kaikki kannet ennen käyttöä.

⚠ HUOMIO – Varmista, että moottorin tarvitsema sähkönsyöttöjännite vastaa jakeluverkon jännitettä ja että sähkönsyöttökaapelit vastaavat pumpun tehoa ja virtaa.

⚠ HUOMIO – Lue ja noudata kaikkia tämän käyttöoppaan sisältämiä ja laitteeseen merkittyjä ohjeita. Ohjeiden noudattamatta jättäminen voi aiheuttaa ruumiinvamman. Tämä asiakirja on toimitettava uima-altaan omistajalle, jonka on säilytettävä se turvallisessa paikassa.

⚠ HUOMIO – Yli 8-vuotiaat lapset ja henkilöt, joilla ei ole tarvittavaa tietoa tai kokemusta tai joilla on fyysisiä, henkisiä tai aistivammissa, voivat käyttää tätä laitetta, jos he ovat saaneet asianmukaiset ohjeet ja ymmärtävät sen käyttöön liittyvät vaarat. Lapset eivät saa leikkiä laitteella. Lapset eivät saa suorittaa puhdistusta ja käyttäjän huoltamista, elleivät he ole yli 8-vuotiaita ja heidän valvonnassaan. Pidä laite ja johto poissa alle 8-vuotiaiden lasten ulottuvilta.

⚠ HUOMIO – Pumppu on suunniteltu jatkuvaan käyttöön, kun veden lämpötila on enintään 35°C.

⚠ HUOMIO – Käytä vain aitoja Hayward®-varaosia.

⚠ HUOMIO – Jos virtajohto on vaurioitunut, valmistajan, sen jälleenmyyjän tai vastaavan pätevyyden omaavan henkilön on vaihdettava se vaarojen välttämiseksi.

⚠ HUOMIO – Ulkoinen kytkin, jossa on kaikkien napojen kosketinerotus ja joka mahdollistaa täydellisen katkaisun kategorian III ylijänniteolosuhteissa, on asennettava kiinteään johtoon, joka on virransyötöstä irrottamista koskevien johdotussääntöjen mukainen.

⚠ HUOMIO – Älä käytä allaspumppua, jos liitännäkaapeli tai moottorin liitännärasian kotelo on vaurioitunut. Tämä voi aiheuttaa sähköiskun. Vioittunut virtajohto tai moottorin liitännärasia on välittömästi vaihdettava teknikon tai vastaavan pätevyyden omaavan henkilön toimesta vaaran välttämiseksi.

⚠ HUOMIO – Tämä allasmoottori EI ole varustettu turvavyhjiövapautusjärjestelmällä (SSLV). SSLV auttaa estämään hukkumista kehon juuttumisesta vedenalaisiin viemäreihin. Joissakin allaskokoonpanoissa, jos henkilön ruumis peittää viemäriin, henkilö voi jäädä loukkuun imulla. Allaskokoonpanostasi riippuen SSLV voidaan vaatia paikallisten koodivaatimusten täyttämiseksi.

⚠ HUOMIO – Tämä pumppu sisältää akun, jota turvallisuussyistä kaikki käsittelyt saa suorittaa pätevä tekninen palvelu.

KÄYTÄ AINOASTAAN ALKUPERÄISIÄ HAYWARD®-VARAOSIA

YLEISTÄ

Olet tehnyt hyvän päätöksen ostaessasi Hayward®-pumpun säädettävällä nopeudella.

Hayward® -pumpuissa säädettävällä nopeudella on kestromagneettimoottori elektronisella uudenaikaisella vaihtovirran kytkennällä. Moottoria ohjaa taajuudenvaihtimeen liitetty mikroprosessori, joka mahdollistaa seuraavat ominaisuudet:

- Pyörimisnopeuden osoitus valvontanäytössä
- 3 tehtaalla esiasetettua pyörimisnopeutta (näppäimet V1, V2, V3), joita käyttäjä voi säätää
- Esitäyttö jokaisen käynnistyksen yhteydessä, säädettävä esitäyttönopeus ja -kesto
- Skimmer-toiminto, pintaveden puhdistus
- Ohjelmoitava ajastintoiminto
- Hetkellisen kulutuksen osoitus
- Kokonais- ja osittaiskulutuksen osoitus
- Pumpun toiminta-ajan osoitus
- Vähäinen äänitaso
- Valmistusstandardi TEFC IP55

Asenna pumppu etäälle altaasta yhteyden vähentämiseksi mahdollisimman paljon imun ja pumpun välillä, jotta rajoitetaan turhia ja liiallisia painehäviöitä hydraulipiirissä.

On ehdottomasti noudatettava voimassa olevan asennuslain vaatimaa turvaetäisyyttä. Asenna ja käytä tuotetta korkeudessa alle 2000m

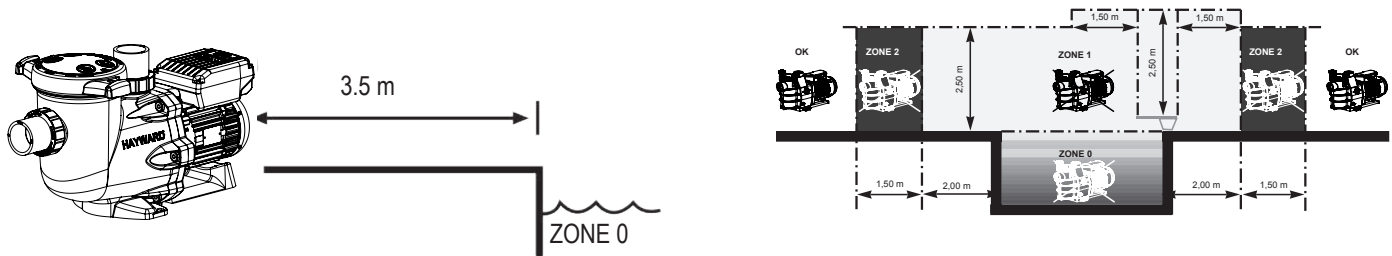

Asenna pumppu tuuletettuun ja kuivaan paikkaan, moottori tarvitsee vapaasti kiertävää ilmaa sen ympärille luonnollisen tuuletuksen mahdollistamiseksi. Varaa pumpun ympärille vähintään 0,5 m tyhjää tilaa. Tarkasta säännöllisesti, etteivät esineet, lehdet tai mikään muu tilaa vievä tuki moottorin jäähdytystä.

Pumppu on asennettava niin, että irtikytkennän ulkokatkaisin, joka on sisäänrakennettu kiinteään rasiaan, näkyy ja on helposti saatavilla. Katkaisimen on oltava lähellä pumpua.

Pumppu on asennettava pysyvästi betonijalustalle sen betoniin sopivien ruuvien, Ø 8 mm, avulla, jotka ruuvataan tehtyihin sijoihin tai asennusaukkoihin. On laitettava lukitusaluslevyt asennusruuvien löystymisen estämiseksi ajan kuluessa. Jos pumppu on asennettava puutasolle, on käytettävä puulle sopivia kuusiokantaisia puuruuveja, Ø 8 mm – sekä lukituslaattoja löystymisen estämiseksi ajan kuluessa.

Asenna pumppu suojaan niin, ettei ohjausrasia altistu suurille vesimäärille.

Hayward®-pumpujen äänipaine on alle 70 dBA.

Tarvittavat määräykset:

- Liitä pumppu maadoitukseen: Älä koskaan käytä pumpua, jos sitä ei ole liitetty maadoitukseen.
- Liitä pumppu kaapelilla, joka on tyyppiä H07RN-F 3G1,5mm².
- Varaa differentiaalisuojalaite 30 mA, joka suojaaa ihmisiä sähköiskuilta, jotka aiheutuvat mahdollisesta laitteiston sähköeristyksen murtumasta.
- Varaa suoja oikosulkuja vastaan (koko määritellään moottorin kyltissä olevan arvon mukaan).
- Varaa sähköverkosta irtikytkentätapa, jonka kaikkien napojen kosketusten avausväli varmistaa täyden katkaisun ylijännitetilanteessa, jonka luokka on III.

⚠ HUOMIO: Odota 5 minuuttia pumpun irtikytkemisen jälkeen kokonaan sähköverkosta ennen kuin kosket moottoriin tai kytkinrasiaan: **Sähköiskuvaara voi aiheuttaa kuoleman.**

Pumpuissa olevissa sähkömoottoreissa on lämpösuoja, joka reagoi ylikuormituksen tai moottorin käämityksen epätavallisen kuumenemisen aikana. Suoja palaa ennalleen automaattisesti käämityksen lämpötilan laskiessa.

Jos määräykset vaativat ja moottoritypistä riippumatta on asennettava yllä lueteltujen laitteiden lisäksi lämpömagneettinen suoja, joka on mitoitettava moottorin kyltin ohjeiden mukaan.

Sivulla 169 olevassa taulukossa on pumpuissa olevien moottoreiden eri ominaisuudet.

Sähköliitos: Varmista, että moottorin vaatima virransyötön jännite vastaa jakeluverkon jännitettä ja että sähkökaapelin leikkaus ja pituus sopivat pumpun tehoon ja voimakkuuteen.

Pumpun sähköliitokset sekä mahdollisen sähkökaapelin vaihdon tekee ammattitaitoinen henkilö vaaran välttämiseksi.

Sähköliitosten tekemiseksi noudata liittimien alle merkittyä merkintää.

Tarkasta kunnolla sähkökytkentöjen kiristys ja tiiviys ennen jännitteen laittoa.

Noudata tarkasti kaapelin läpivientiä siihen tarkoitettuista aukosta ja ferriitistä; kaapelitiiviste varmistaa tiiviyn kaapelin ympärillä, ferriitti muodostaa suodattimen sähkömagneettisille häiriöille.

Mahdollinen esikaapelointi, joka on joissakin pumpuissa, on poistettava pumpun lopullisen liitoksen aikana sähkönsyöttöön. Itse asiassa tätä esilaitteistoa käytetään vain testejä varten tehtaalla valmistusvaiheiden aikana.

ASENNUS

Asenna uima-altaan pumppu rajoittaen maksimissaan painehäviöitä noudattaen etäisyyssehtoja, vähintään 3,5 m sen ja uima-altaan välillä, kuten asennuslaissa NF C 15-100 määritellään. Imukanava on asennettava pumpun akselia kohti nousevaan heikkoon kaltevuuteen. Varmista, että liitokset on kunnolla kiristetty ja tiiviit. Vältä kuitenkin putkiston kiinnittämistä liioitellusti. Muovimateriaaleilla varmista tiiviys vain Teflonilla. Imuputken halkaisija on suurempi tai vähintään samankokoinen kuin painepuolella. Vältä kosteita sijoituspaikkoja tai paikkoja, joissa ei ole tuuletusta. Moottori vaatii vapaasti kiertävää jäähdytysilmaa. Asenna pumppu suojaan niin, ettei ohjausrasia altistu suurille vesimäärille.

KÄYNNISTYS- JA VIRITYS- OHJEET: Täytä esisuodattimen runko vedellä imuputken tasoon asti. Älä koskaan käytä pumppua ilman vettä, vesi on välttämätöntä jäähdytykselle ja mekaanisen venttiilin voitelulle. Avaa kaikki imu- ja painepuolen kanavien venttiilit sekä suodattimen ilmantyhjennys, jos sellainen on mukana. (Kaikki ilma on tyhjennettävä imukanavasta). Käynnistä laite ja odota tarvittava aika viritystä varten. Viisi minuuttia ei ole liian pitkä aika viritykselle (viritys riippuu imun korkeudesta ja imuputken pituudesta). Jos pumppu ei käynnisty tai viritystä ei tapahdu, katso vianetsintäopas.

OHJAUSYKSIKÖN KÄYTTÖ

1. ESITTELY

Muuttuvanopeuksista Hayward®-pumppua ohjataan ohjausyksiköllä, jonka näytössä näkyvät säädettävät toimintaparametrit. Myös ajastustila voidaan ohjelmoida ohjausyksiköllä.

1	Jännitteensyötön kytkennän LED-merkkivalo
2	LCD-näyttö
3	Pyörimisnopeuden valinta
4	Manuaalisen tilan / ajastustilan vaihto
5	Säädön ylös/alas-nuolinäppäimet
6	Virtakytkin
7	Parametrien tarkastelunäppäin
8	Valitun pyörimisnopeuden LED-merkkivalot

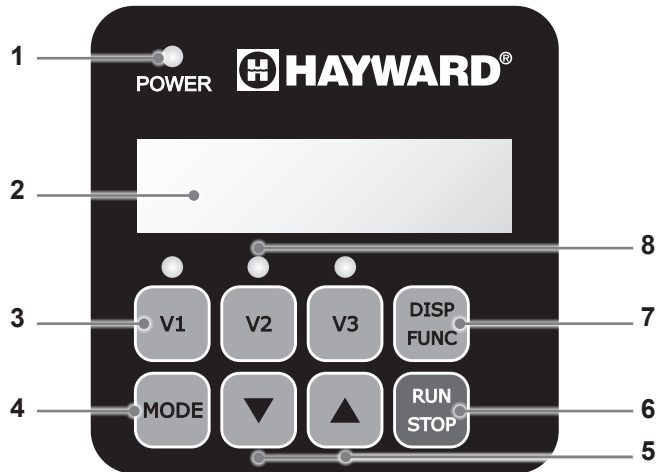

Pumpun toimituksen yhteydessä ohjausyksikköön on tallennettu **OLETUSPARAMETRIT** (tehdassäädöt):

Esitäyttö kesto (s)	Esitäyttö nopeus (r/min)	V1 (r/min)	V2 (r/min)	V3 (r/min)	Skimmer kesto (min)	Skimmer toimintajakso (h)	Skimmer pyörimisnopeus (r/min)
240	3000	1500	2400	3000	15	1 h	2800

r/min: kierrosta minuutissa

KÄYTÄ AINOASTAAN ALKUPERÄISIÄ HAYWARD®-VARAOSIA

2. PUMPUN TOIMINTATILAT

2.1 Manuaalinen tila

Manuaalisessa käyttötilassa käyttäjä käynnistää ja pysäyttää pumpun manuaalisesti uima-altaan käytön mukaan.

- Pumpun käynnistäminen aloittaa esitäyttövaiheen **(a)**. Tätä vaihetta voidaan säätää (pyörimisnopeus ja kesto, kohta 4.2). Esitäyttö voidaan keskeyttää käynnistyksen yhteydessä (kohta 3.2) ja poistaa käytöstä säätötoiminnoilla.
- Tämän jälkeen pumpun pyörimisnopeus vakiintuu tasaiseen arvoon **(b)** (vakionopeuden oletusarvo V2). Käyttäjä voi valita pyörimisnopeuden ja säätää sitä (kohta 3.3).
- Pysäytyksen/uudelleen käynnistyksen jälkeen pumpun pyörimisnopeus vakautuu viimeiselle muistiin tallentuneelle nopeudelle.

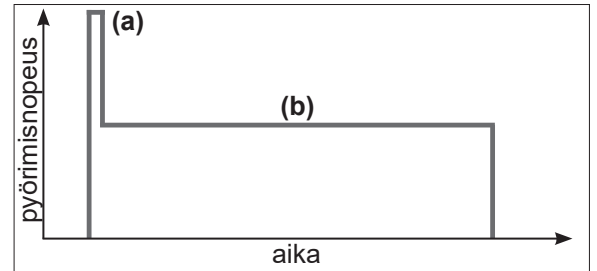

2.2 Skimmer-puhdistustoiminto

Skimmer-toiminnolla voidaan poistaa epäpuhtaudet veden pinnalta, jotta siihen ei kerääny likaa.

- Tämä on automaattinen toiminto: pumppu pyörii suuremmalla pyörimisnopeudella **(c)** tietyn ajan ja toimintajakson, jotka voidaan säätää.
- Pyörittynään suuremmalla pyörimisnopeudella pumppu palaa normaalinopeudelle sekä manuaalisessa että ajastustilassa.
- Skimmer-toiminto voidaan poistaa käytöstä (katso säätötoiminnot kohdassa 4.3).

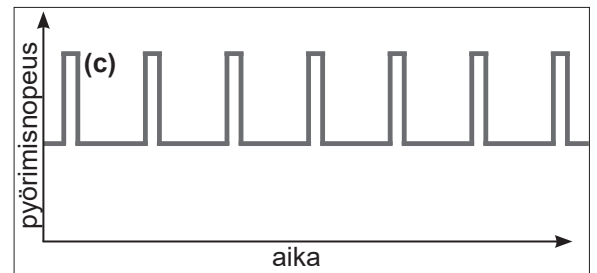

2.3 Ajastustila (Timer)

Ajastustilassa pumppu toimii automaattisesti vuorokauden ympäri. Käyttäjä voi ohjelmoida erilaisia pyörimisnopeusjaksoja **(d)**. Pyörimisnopeusjaksot valitaan uima-altaan laitteiston (lämmitystapa, energiansäästö jne.) ja käyttöaikataulujen mukaan.

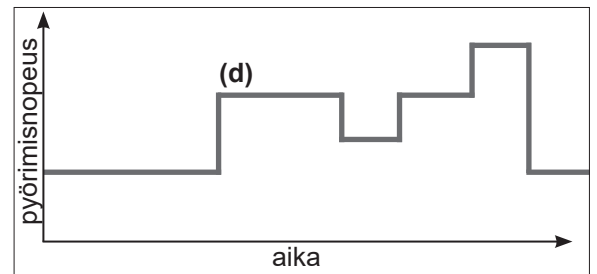

- Jos Skimmer-toiminto on aktivoitu, se ohittaa muut jaksot.
- Pumppu voidaan pysäyttää (toiminta keskeyttää) ajastustilassa. Uudelleen käynnistettäessä pyörimisnopeus palautuu käynnissä olevan ajastuksen asetuksen mukaiseksi.
- Ajastustilan ohjelmointi: katso kohtaa 4.5.



2.4 Manuaalisen/ajastustilan vaihtaminen

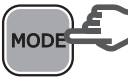

Tila vaihdetaan näppäimellä  ohjeisen kuvan mukaan:

Manuaalinen tila

Nopeuslukeman edessä ei ole merkintää  → 

Ledimerkkivalo osoittaa valitun pyörimisnopeuden (oletusnopeus on V2) 

Ajastustila (Timer)

Nopeuslukeman edessä on merkintä "t"  → 

Ledit eivät pala 

KÄYTÄ AINOASTAAN ALKUPERÄISIÄ HAYWARD®-VARAOSIA

2.5 Sisäisten digitaalitulojen kytkentä

△ HUOMAUTUS: Ennen pumpulle tehtäviä sähkötyöitä katkaise verkkovirransyöttö ja odota 5 minuutin ajan.

Suodatuspumpussa on 3 metriä pitkä viisijohtiminen kaapeli, johon voidaan kytkeä 4 digitaalituloa tai potentiaalivapaata kytkintä (auki/kiinni).

Esimerkkejä digitaalitulojen käytöstä

- Oheislaitteiden, kuten lämpöpumpun, ulkosälekaihtimien tai robotti-imurin, toiminnan edellyttämän nopeuden ja virtaaman säätö
- Käyttöliittymän seurannan asennus. Näiden digitaalitulojen avulla voidaan kauko-ohjata 3 metrin etäisyydeltä Run/Stop-toimintoa sekä 3 nopeutta (V1 – V2 – V3).

Johtimien järjestys		
DI1	Ruskea	Nopeus V1
DI2	Vihreä	Nopeus V2
DI3	Valkoinen	Nopeus V3
DI4	Punainen	Run/Stop
C	Musta	Yhteinen

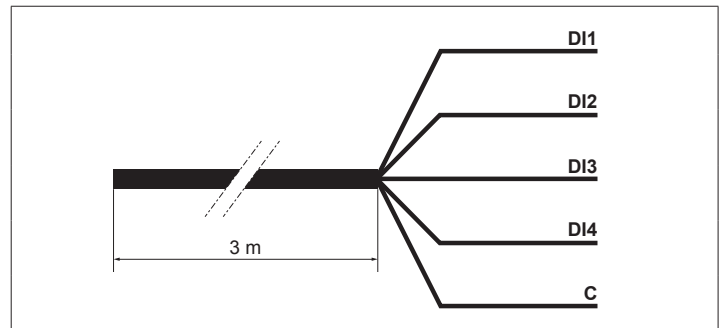

Huomautus:

- Jos vain osaa digitaalituloista käytetään, tee käyttämättömien johtimien sähköinen eristys.
- Jos yhtään digitaalituloa ei käytetä, aseta liitin (A) viisijohtimisen kaapelin tilalle (katso oheista kuvaa).

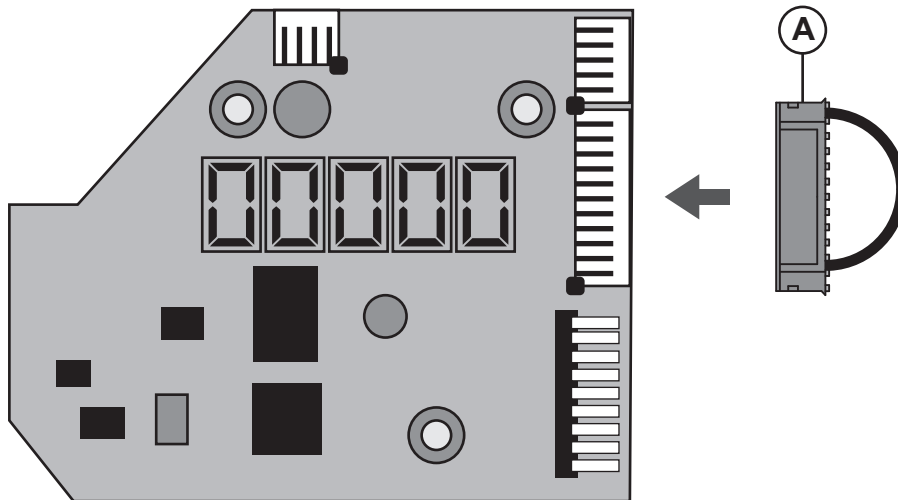



KÄYTÄ AINOASTAAN ALKUPERÄISIÄ HAYWARD®-VARAOSIA

Digitaalitulojen toiminta

<p>Digitaalituloja voidaan käyttää manuaalisessa tilassa tai ajastintilassa.</p> <p>Niillä on suurin prioriteetti: ne toimivat MASTER-tilassa kaikille käynnissä oleville toiminnoille.</p> <p>Ainoastaan Run/Stop-kytkin ja DISP/FUNC-kytkin ovat käytössä.</p>	→	
	→	
<p>Kun digitaalitila on käytössä, kyseisen nopeuden ledimerkkivalo vilkkuu nopeasti (DI1 = V1, DI2 = V2 tai DI3 = V3).</p>	→	

<p>DI4-tulon pitää olla suljettu, jotta toiminto toimii digitaalitulojen kautta.</p>	→	DI4 Run/Stopsuljettu		
<p>Jos useita digitaalituloja kytketään samanaikaisesti, ne kytkeytyvät yksitellen oheisen taulukon mukaisessa prioriteettijärjestyksessä.</p>		DI1 = V1	DI2 = V2	DI3 = V3
	DI1 = V1	V1	V2	V3
	DI2 = V2	V2	V2	V3
	DI3 = V3	V3	V2	V3

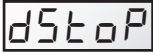
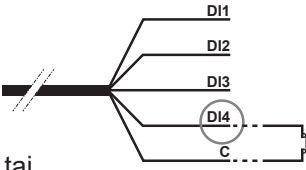
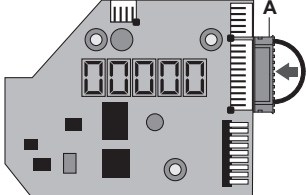
Huomautus: Kun digitaalituloon yhdistetty toiminto on päättynyt (kytkin on auki), suodatuspumppu palaa käynnissä olevaan toimintatilaan.

<p>Jos digitaalitulo DI4 on auki, suodatinpumppu ei käynnisty, ja pumpun näytöllä näkyy dSTOP.</p> <ul style="list-style-type: none"> Sulje tulo DI4. Paina tarvittaessa painiketta RUN/STOP, jotta suodatinpumppu käynnistyy uudelleen. 	→	
	→	 <p>tai</p> 
	→	







3. KÄYTTÖ

3.1 Jännitteensyötön kytkentä



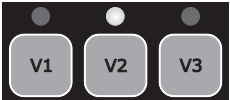



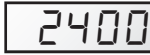
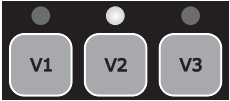

Power-merkkivalo syttyy; järjestelmä tekee LCD-näytön testin, minkä jälkeen näyttöön tulee ohjelmistoversio		→		→	
---	---	---	---	---	---

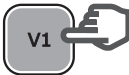
3.2 Esitäyttövaihe

Esitäyttövaihe alkaa automaattisesti, kun pumpun jännitteensyöttö kytketään (ja pumpun uudelleenkäynnistyksen jälkeen).



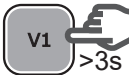



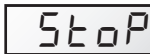

Automaattinen esitäyttövaiheen käynnistys: • Pyörimisnopeus nousee lukemaan 3000 r/min ja sitä ylläpidetään 240 sekunnin ajan (oletusarvo)		→		
Esitäyttövaiheen lopetus: • Pumpun pyörimisnopeus vakiintuu oletusarvoon V2 tai edelliseen muistiin tallennettuun arvoon • Vastaava ledimerkkivalo syttyy (manuaalisessa tilassa).		→		
Voit tarkistaa jäljellä olevan esitäyttöajan seuraavasti: • Paina DISP/FUNC • Jäljellä oleva aika tulee näyttöön (sekuntia)		→		
Esitäytön keskeyttäminen: • Paina RUN/STOP • Pyörimisnopeus vakautuu oletuksena nopeudelle V2 tai viimeiselle muistiintallentuneelle nopeudelle		→		

3.3 Manuaalinen tila: pyörimisnopeuden valinta, säätö ja tallennus

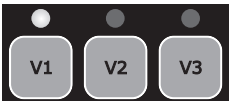
Pyörimisnopeuden valinta: • Paina yhtä nopeusnäppäintä • Näyttöön tulee oletusarvo (r/min) • Vastaava ledi syttyy		→		
Uuden nopeusarvon säätäminen: • Paina ylös-/alas-nuolinäppäimiä • Ledi vilkkuu: säätö käynnissä • Säädä haluttu arvo (600–3000 r/min)		→		
Uuden nopeusarvon tallentaminen: • Paina nopeusnäppäintä 3 sekunnin ajan • Ledi palaa yhtäjaksoisesti, kun pyörimisnopeus on tallentunut		→		

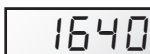
Huomaa: Pumpun pyörimisnopeuden aikaansaama virtaama pitää sovittaa laitteiston (suodattimen, putkistojen) kapasiteetin mukaan. Jos et ole varma säädöstä, ota yhteyttä asiantuntijaan.

3.4 Pumpun pysäyttäminen/uudelleenkäynnistys















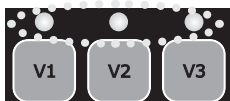

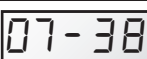
Pumpun pysäyttäminen: • Paina RUN/STOP • Pumppu pysähtyy, pyörimisnopeuden lediosoitus jää palamaan • Manuaalisessa tilassa näytön "StoP"-osoitus palaa yhtäjaksoisesti. Ajustustilassa näytön "StoP"-osoitus vilkkuu		→	 	
Pumpun uudelleenkäynnistys: • Paina RUN/STOP • Pumppu käynnistyy uudelleen esitäyttövaiheessa (kohta 3.2) • Pyörimisnopeutus vakautuu: manuaalisessa tilassa edelliseen tallennettuun arvoon, ajastustilassa ajastimen tallennetulle pyörimisnopeudelle		→	 → 	 

KÄYTÄ AINOASTAAN ALKUPERÄISIÄ HAYWARD®-VARAOSIA













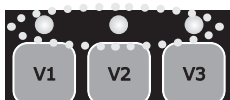

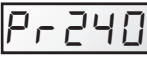





4. SÄÄDÖT

Huomaa: Säädon yhteydessä pumpun virransyötön pitää olla kytkettynä ja pumpun pitää olla **manuaalisessa tilassa** (kohta 2.4), pysähdyksissä tai käynnissä muussa kuin esitäyttövaiheessa.
Jos näppäimiä ei paineta 2 minuutin aikana, näyttö palaa normaaliksi (osoittaa pyörimisnopeuden tai StoP) eivätkä säädöt tallennu.

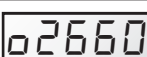
4.1 Kellon säätäminen

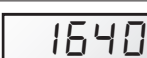
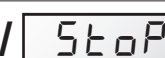
<ul style="list-style-type: none"> Paina 3 sekunnin ajan DISP/FUNC 3 lediä vilkkuu Näytössä näkyy "ConF" ja tämän jälkeen "hr" 						
<ul style="list-style-type: none"> Paina DISP/FUNC, jolloin näyttöön tulee sisäisen ajan osoitus (hh-min) 						
<ul style="list-style-type: none"> Säädä tunti-/minuuttimäärä alas/ylösnuolinäppäimillä 						
<ul style="list-style-type: none"> Lopeta ja tallenna säätö painamalla RUN/STOP Näytössä näkyy pyörimisnopeus tai StoP 						
<p>Huomaa: Sisäisen kellon säätäminen on tärkeää, jos pumpua käytetään ajastustilassa. Kellonaika pysyy muistissa, kun pumpun jännitteensyöttö katkaistaan.</p>						

4.2 Esitäytön säätäminen

<ul style="list-style-type: none"> Paina 3 sekunnin ajan DISP/FUNC-näppäintä 3 lediä vilkkuu ja näytössä näkyy "ConF" 					
<ul style="list-style-type: none"> Paina DISP/FUNC-näppäintä niin monta (n) kertaa, että näytössä näkyy "Pr 240", joka on esitäytön oletuskesto (s) 					
<ul style="list-style-type: none"> Paina ylös-/alas-nuolinäppäintä, kunnes näytössä on haluttu kesto (0–300 s) 					
<ul style="list-style-type: none"> Paina DISP/FUNC-näppäintä: näytössä näkyy "o3000", joka on esitäytön oletusnopeus (r/min) 					
<ul style="list-style-type: none"> Paina ylös-/alas-näppäintä, kunnes näytössä on haluttu arvo (korkeintaan 3000 r/min) 					
<ul style="list-style-type: none"> Lopeta ja tallenna säätö painamalla RUN/STOP Näytössä näkyy pyörimisnopeus tai StoP 					
<p>Huomaa: Jos esitäytön kesto on nolla, näytössä näkyy "ProFF": esitäyttö on poissa käytöstä</p>					
					

4.3 Skimmer-puhdistustoiminnon säätö

Katso toiminnon esittely kohdasta 2.2.

<ul style="list-style-type: none"> Paina 3 sekunnin ajan DISP/FUNC-näppäintä 3 lediä vilkkuu ja näytössä näkyy "ConF" 		→	ConF	
<ul style="list-style-type: none"> Paina DISP/FUNC-näppäintä niin monta (n) kertaa, että näytössä näkyy "SFO.15", joka on Skimmer-toiminnon aktivoinnin oletuskesto (minuuttia) 		→	SFO.15	
<ul style="list-style-type: none"> Paina ylös-/alas-näppäintä, kunnes näytössä on haluttu kesto (0–30 min) 		→	SFO20	
<ul style="list-style-type: none"> Paina DISP/FUNC-näppäintä: näytössä näkyy "St 1h", joka on Skimmer-toimintojakson oletuskesto 		→	St 1h	
<ul style="list-style-type: none"> Säädi säätönäppäimillä Skimmer-toimintojakson kestoksi 1 h, 2 h tai 3 h 		→	St 2h	
<ul style="list-style-type: none"> Paina DISP/FUNC-näppäintä: näytössä näkyy "S2800", joka on Skimmer-toiminnon oletusnopeus (r/min) 		→	S2800	
<ul style="list-style-type: none"> Paina ylös-/alas-näppäintä, kunnes näytössä on haluttu pyörimisnopeus (600–3000 r/min) 		→	S2680	
<ul style="list-style-type: none"> Lopeta ja tallenna säätö painamalla RUN/STOP Näytössä näkyy pyörimisnopeus tai Stop 		→	1640 / Stop	
Huomaa: Skimmer-puhdistustoiminto poistetaan käytöstä säätämällä pyörimisnopeudeksi nolla, jolloin näytössä näkyy "SFOFF"		→	SFOFF	

4.4 Parametrien palautus

Palauta oletusparametrit ja poista ajastustilan säädöt seuraavasti:

<ul style="list-style-type: none"> Paina 3 sekunnin ajan DISP/FUNC-näppäintä 3 lediä vilkkuu ja näytössä näkyy "ConF" 		→	ConF		
<ul style="list-style-type: none"> Paina DISP/FUNC-näppäintä niin monta (n) kertaa, kunnes näytössä näkyy "Init" 		→	Init		
<ul style="list-style-type: none"> Paina ylös-nuolinäppäintä 3 sekunnin ajan. Kun palautus on valmis, näyttöön tulee teksti "donE" 		→	donE	→	Stop

Yhteenveto: oletusparametrit ja säätöalueet

	Esitäyttö		Nopeusnäppäimet			Skimmer-toiminto			Ajastustoiminto			
	Pr	σ---	V1	V2	V3	SF	St	S---	t0	t1	t5	
Yksikkö	s	r/min	r/min	r/min	r/min	min	h	r/min	hh-min	r/min	hh-min	r/min
Oletusarvo	240	3000	1500	2400	3000	15	1	2800	06-00	2400	oFF	0
Mini	0 (oFF)	600	600	600	600	0 (oFF)	1 ...	600	00-00	—	00-00	0/ 600
Maxi	300	3000	3000	3000	3000	30	... 3	3000	24-00	—	24-00	3000

KÄYTÄ AINOASTAAN ALKUPERÄISIÄ HAYWARD®-VARAOSIA

4.5 Ajastustilan ohjelmointi

Ohjausyksiköllä voidaan ohjelmoida useita jaksoja (katso kohtaa 2.3) tai ajastukset t0–t5, joita ei tarvitse välttämättä ohjelmoida kronologisessa järjestyksessä.







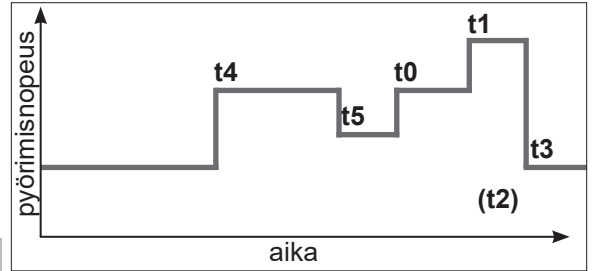





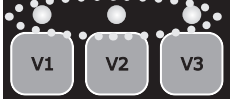



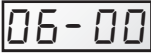

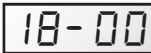



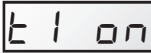

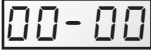

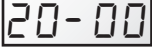



Ohjelmoimattomat ajastukset poistuvat käytöstä.

Ajastus "t0" voidaan määrittää pysyvästi arvoon 00:00, 06:00 (oletus), 12:00 tai 18:00. Sitä ei voida poistaa käytöstä.

t0-ajastusjakson pyörimisnopeutta ei voida säätää, vaan se on kiinteä 2400 r/min.





















- Voit jäljittää nopeusprofiiliin, jonka haluat ohjelmoida. Oheisessa kaaviossa näet esimerkin profiilista.
- Tarkista, että sisäinen kello on säädetty oikein.

• Paina 3 sekunnin ajan DISP/FUNC-näppäintä 3 lediä vilkkuu ja näytössä näkyy "ConF"	 >3s	→		
• Paina DISP/FUNC-näppäintä 2 kertaa, kunnes näytössä näkyy "t0"	 x 2	→		
• Paina DISP/FUNC-näppäintä: näytössä näkyy "06-00", joka on t0-ajastuksen oletusarvo		→		
• Säädä säätönäppäimillä haluttu t0-arvo (00-00, 06-00, 12-00 tai 18-00)	 	→		
• Paina DISP/FUNC-näppäintä: näytössä näkyy "t1oFF"		→		
• Tämä ajastin (esimerkki) aktivoidaan painamalla ylös-nuolinäppäintä. Näytössä näkyy "t1 on"	 	→		
• Paina DISP/FUNC-näppäintä: näytössä näkyy "00-00"		→		
• Säädä haluamasi käyttöaikataulu (hh-mm) alas/ylös- nuolinäppäimillä	 	→		 → 
• Paina DISP/FUNC-näppäintä: näytössä näkyy "0"		→		
• Paina säätönäppäimiä, kunnes näytössä on haluttu pyörimisnopeus (600–3000 r/min tai nolla)	 	→		
• Siirry seuraavaan ajastimeen painamalla DISP/ FUNC: näytössä näkyy "t2oFF". Esimerkissä tämä ajastin on poissa käytöstä		→		
• Siirry seuraavaan ajastimeen painamalla DISP/FUNC ja toista säätövaiheet (aktivointi, ajastintoiminnon käyttöaikataulu ja pyörimisnopeus)		→		etc ...
• Lopeta ja tallenna säätö painamalla RUN/STOP Näytössä näkyy pyörimisnopeus tai StoP		→		

KÄYTÄ AINOASTAAN ALKUPERÄISIÄ HAYWARD®-VARAOSIA

5. PARAMETRIEN TARKASTELU

Huomaa: Pumpun virransyötön täytyy olla kytkettynä ja sen pitää olla käynnissä (muussa kuin esitäyttötilassa) tai pysähdyksissä.
 Voit vierittää parametreja painamalla DISP/FUNC-näppäintä.
 Jos et paina näppäimiä 15 sekunnin aikana, näyttö vaihtuu perusnäyttöön (käytössä oleva pyörimisnopeus tai Stop).

<ul style="list-style-type: none"> Paina DISP/FUNC-näppäintä: näyttöön tulee "hr" Paina näppäintä uudelleen: näyttöön tulee laitteen sisäinen aika 	 → hr	 → 11-45
<ul style="list-style-type: none"> Paina DISP/FUNC-näppäintä: näyttöön tulee "t0" Paina näppäintä uudelleen: näyttöön tulee t0-käyttöaikataulu (t0-parametrin pyörimisnopeus on kiinteä 2400 r/min) 	 → t0	 → 12-00
<ul style="list-style-type: none"> Paina DISP/FUNC-näppäintä: näyttöön tulee "t1" Paina näppäintä uudelleen: näyttöön tulee tämän ajastimen käyttöaikataulu (hh-mm) 	 → t1	 → 09-20
<ul style="list-style-type: none"> Paina DISP/FUNC-näppäintä: tämän ajastimen pyörimisnopeuden osoitus (r/min) 	 → 1240	
<ul style="list-style-type: none"> Paina DISP/FUNC-näppäintä toistuvasti: seuraavien ajastimien, käyttöaikataulun ja pyörimisnopeuden näyttö ajastimeen "t5" saakka <p>Huomaa: Käytöstä poistetut ajastimet eivät tule näyttöön</p>	 → t2	etc ...
<ul style="list-style-type: none"> Paina DISP/FUNC-näppäintä: näyttöön tulee "P - - -" Käytetty teho (wattia, arvo +/- 10 %) <p>Huomaa: P = 0 wattia, kun pumppu ei pyöri</p>	 → P 634 / P 0	
<ul style="list-style-type: none"> Paina DISP/FUNC-näppäintä: näyttöön tulee "h - - -" Pumpun käyttötuntilaskuri <p>Huomaa: Laskurin kierros on 9999 h</p>	 → h2857	
<ul style="list-style-type: none"> Paina DISP/FUNC-näppäintä: näyttöön tulee "- - -" Kokonaisenergiankulutus (kWh) <p>Huomaa: Laskurin kierros on 99999 kWh</p>	 → 06542	
<ul style="list-style-type: none"> Paina DISP/FUNC-näppäintä: näyttöön tulee "- - -" Osittainen energiankulutus (kWh) edellisen nollauksen jälkeen 	 → 00086	
<ul style="list-style-type: none"> Energiankulutuksen osittaislaskurin nollaaminen: Paina 3 sekunnin ajan ylös- tai alasnuolinäppäintä. <p>"CLEAR"-viesti osoittaa, että mittari on nollattu</p>	  → CLEAR	
<ul style="list-style-type: none"> Paina DISP/FUNC-näppäintä: Näytön "SF On" tai "SFOFF" osoittaa Skimmer-puhdistustoiminnon olevan käytössä / poissa käytöstä 	 → SF On / SFOFF	
<ul style="list-style-type: none"> Paina DISP/FUNC-näppäintä: Näyttöön tulee "t - -" <p>Tehomodulin lämpötila (°C)</p>	 → t 74	
<ul style="list-style-type: none"> Palaa normaalinäyttöön painamalla DISP/FUNC-näppäintä (pyörimisnopeus tai Stop) 	 → 1640 / Stop	 → t2400 / Stop

KÄYTÄ AINOASTAAN ALKUPERÄISIÄ HAYWARD®-VARAOSIA

HUOLTO

1. Irtyktyke pumpppu kokonaan verkkovirtasyötöstä ennen kuin avaat kannen ja puhdistat esisuodattimen. Puhdista esisuodattimen kori säännöllisesti, älä hakkaa koria sen puhdistamiseksi. Tarkasta esisuodattimen kannen tiiviste ja vaihda se tarvittaessa.
2. Moottorin akseli on koottu itsevoiteleville laakereille, jotka eivät vaadi lisävoitelua.
3. Pidä moottori puhtaana ja kuivana sekä varmista, että tuuletusaukot ovat vapaat kaikista esteistä.
4. Mekaanisessa venttiilissä saattaa joskus paljastua vuoto, jolloin se on vaihdettava.
5. Uima-altaan puhdistusta lukuun ottamatta kaikki korjaus-, ylläpito- ja huoltotoimenpiteet tekee ehdottomasti hyväksytty Hayward®-asiamies tai ammattitaitoinen henkilö.

Alla mainitut pumpun kuluvat osat tulee huoltaa niiden arvioidun käyttöiän mukaisesti:

Käyttöosien arvioitu eikä:

Turvallinen mekaaninen tiiviste	1 vuosi
Moottorin laakerisarja	1 vuosi
Tiivistesarja (siivin, kotelo, laipit, tiedosto)	2 vuotta
Kondensaattori	2 vuotta

TALVITELOLLE LAITTO

1. Tyhjennä pumpppu poistaen kaikki tyhjennyskorit ja säilytä ne esisuodattimen korissa.
2. Irtyktyke pumpppu, poista putkien liitokset ja säilytä koko laite kuivassa ja ilmastoidussa paikassa tai huolehdi ainakin seuraavasta varoimenpiteestä: irtyktyke pumpppu, poista 4 pumpun rungon kiinnityspulttia moottorin tuessa ja säilytä kokonaisuus kuivassa ja ilmastoidussa paikassa. Suojaa sitten pumpun ja esisuodatimen runko peittämällä ne.

HUOMAA: Ennen pumpun ottamista takaisin käyttöön puhdista kaikki sisäosat poistamalla pöly, kivi jne.

MAHDOLLISET VIAT JA RATKAISUT

A) Moottori ei käynnisty

1. Tarkasta sähköliitokset, katkaisimet tai releet sekä varokkeet tai sulakkeet.
2. Varmista käsin moottorin vapaa pyörintä.
3. Tarkasta, että pyörintänopeuksia V1 V2 ja V3 ei ole ohjelmoitu 0 krs/min, tarpeen vaatiessa suorita tehtaan parametrien uudelleenalustus (katso kohta 4.4).
4. Jos näytössä näkyy jokin oheisista vikakoodeista, ota yhteyttä laitteen asentajaan:

Err01	Johtimen jatkuva alijännite	Err10	Sisäinen virransyötön ongelma
Err02	Johtimen jatkuva ylijännite	Err20	Käynnistys epäonnistunut
Err04	Tehomodulin ylikuumentuminen	Err64	Sisäinen oikosulku
Err05	Moottorin ylikuumentuminen	Err97	Useita ongelmia
Err07	Ylivirta	Err98	Yhteysongelma
		d5toP	Katso sivu 146

B) Moottori pysähtyy, tarkasta

1. Kaapelit, liitokset, releet jne.
2. Jännitteen alenema moottorissa (usein aiheutuu liian heikoista kaapeleista).
3. Ei näy kiinnileikkautumisia eikä ylikuormitusta (absorboidun ampeerimäärän lukemalla).

HUOMAA: Pumpun moottori on varustettu lämpösuojalla, joka ylikuormitustilanteessa katkaisee automaattisesti piirin ja välttää moottorin huonontumisen. Tämä laukaisu aiheutuu epätavallisista käyttöolosuhteista, jotka on välttämätöntä tarkastaa ja korjata. Moottori käynnistyy uudelleen ilman toimenpiteitä heti, kun normaalit toimintaolosuhteet palaavat.

C) «OLOAD» ilmestyy näyttölaitteelle (ylikuormitus- tai ylikuumentumisongelma)

1. Tarkasta, että moottorin akseli pyörii vapaasti.
2. Tarkasta, ettei mikään jäänne tuki turbiinin vapaata pyörintää.
3. Tarkasta, että moottorissa on kunnon tuuletus.
4. Kun olet ratkaissut ongelman, paina painiketta Käynnistys/Pysäytys

D) Pumppu ei käynnisty

1. Varmista, että esisuodattimen runko on kunnolla täynnä vettä, että kannen tiiviste on puhdas, hyvin asetettu ja ettei ilmaa pääse mistään sisään. Kiristä tarvittaessa kannen lukitusruuvit uudelleen.
2. Varmista, että kaikki imu- ja painepuolen venttiilit ovat auki eivätkä tukkiutuneet, ja että kaikki altaan imuaukot ovat kokonaan veden alla.
3. Tarkasta, imeekö pumppu vapauttaen imun mahdollisimman lähellä pumppua:
 - a) eikö pumppu ime huolimatta riittävästä viritysveden täytöstä
 1. Kiristä imupuolen putkiston laitteistot ja pultit
 2. Tarkasta jännite varmistaaksesi, että pumppu pyörii oikealla nopeudella.
 3. Avaa pumppu ja tarkasta, ettei mikään tuki sisäpuolelta.
 4. Säädä esitäyttönopeus riittävän suureksi
 5. Puhdista suodatin ja kokeile uudelleen
 6. Vaihda mekaaninen venttiili.
 - b) Kokeile esitäyttöä kierrätystilassa . Jos pumppu imee normaalisti, tarkasta imukanava ja esisuodatin, jotka voivat olla tukkiutuneet tai varaa ilmanottoja.

F) Äänekäs pumppu, tarkasta

1. ettei mikään sisääntulo tai ilma imussa aiheuta kumeita ääniä pumpussa.
2. ettei imukanavan riittämätön halkaisija tai ahtauma aiheuta kavitaatiota. Myös liian iso kanava painepuolella voi aiheuttaa kavitaation. Käytä oikeanlaisia putkia tai tyhjennä kanavat tarvittaessa.
3. Ettei vääränlainen asennus ei aiheuta tärinää.
4. Ettei pumpun rungossa ole mitään outoa esinettä.
5. Etteivät moottorin laakerit ole tukkiutuneet liian suuren välyksen, ruosteen tai pitkittyneen ylikuumenemisen takia.



HAYWARD®

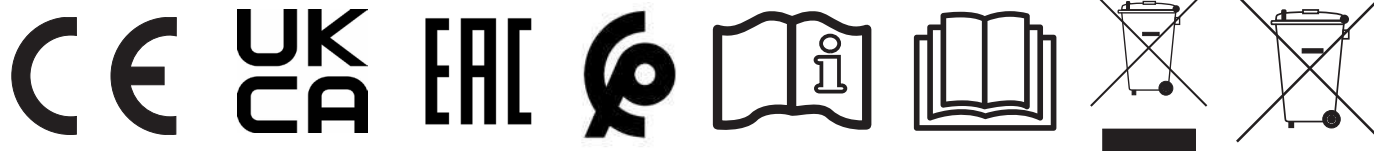
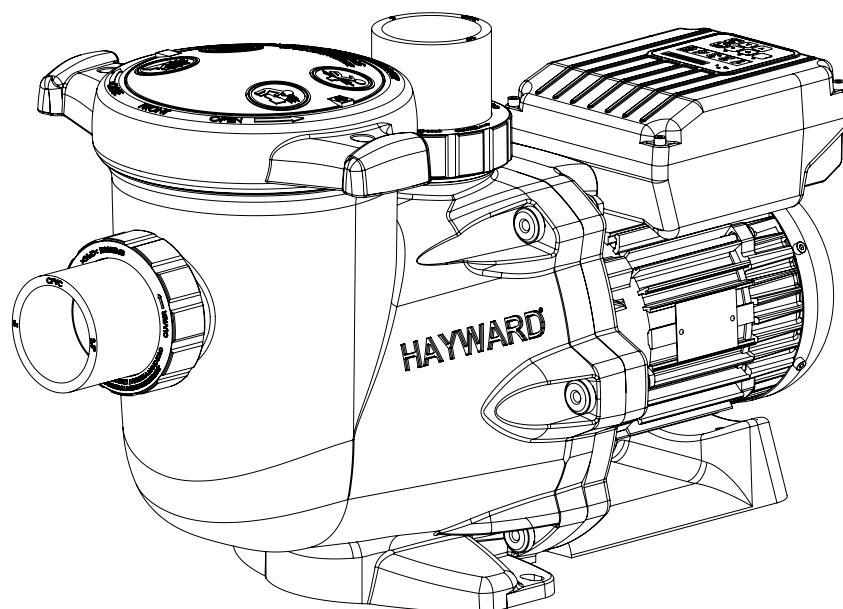

ЦЕНТРОБЕЖНЫЙ НАСОС С РЕГУЛИРУЕМОЙ СКОРОСТЬЮ

РУКОВОДСТВО ПО ЭКСПЛУАТАЦИИ

СОХРАНЯЙТЕ ДАННОЕ РУКОВОДСТВО ДЛЯ ДАЛЬНЕЙШЕГО ИСПОЛЬЗОВАНИЯ



ПРЕДУПРЕЖДЕНИЕ: Опасность поражения электротоком. Несоблюдение инструкций может представлять серьезную опасность для жизни. Для использования в плавательных бассейнах

⚠ **ПРЕДУПРЕЖДЕНИЕ** – Перед открыванием крышки фильтра для очистки полностью отсоедините насос от сетевого источника питания.

⚠ **ПРЕДУПРЕЖДЕНИЕ** – Все электрические подсоединения выполняются квалифицированным электриком в соответствии с местными стандартами по электричеству или, в противном случае, Международный стандарт IEC 60364-7-702.

⚠ **ПРЕДУПРЕЖДЕНИЕ** – Следите за тем, чтобы оборудование подключалось только к розетке 230V \surd с защитой от короткого замыкания. Питание к насосу подается разделительным трансформатором или через устройство остаточного тока с номинальным остаточным рабочим током не более 30 мА.

⚠ **ПРЕДУПРЕЖДЕНИЕ** – Дети должны находиться под присмотром, чтобы они не могли играть с оборудованием. Не подносите к отверстиям и движущимся частям пальцы и посторонние предметы.

⚠ **ПРЕДУПРЕЖДЕНИЕ** – Двигатель требуется как следует заземлить. Подключите провод заземления к зеленому болту, а с приборами, подключенными проводом, используйте соответствующую вилку с заземлением.

⚠ **ПРЕДУПРЕЖДЕНИЕ** – При подключении двигателя к другим деталям с заземлением используйте устройство заземления двигателя и провод сечения, соответствующего правилам пользования электроприборами.

⚠ **ПРЕДУПРЕЖДЕНИЕ** – При электроподключении см. диаграмму на шильдике под клеммной коробкой двигателя. Перед подачей питания убедитесь, что все соединения выполнены плотно и изолированы. Перед подачей питания верните на место все крышки.

⚠ **ПРЕДУПРЕЖДЕНИЕ** – Убедитесь, что напряжение двигателя соответствует напряжению вашей электросети, а электрокабели соответствуют вольтажу и току насоса.

⚠ **ПРЕДУПРЕЖДЕНИЕ** – Прочитайте все инструкции в данном руководстве пользователя и на оборудовании. Несоблюдение инструкций может привести к травмам или повреждениям. Настоящий документ передается владельцу бассейна, и владелец обязан сохранять данный документ в безопасном месте.

⚠ **ПРЕДУПРЕЖДЕНИЕ** – Использование, чистка, обслуживание устройства детьми старше восьми лет или лицами, не обладающими достаточными знаниями и опытом, лицами с ограниченными физическими, сенсорными или умственными способностями возможно только после соответствующего инструктажа и под надлежащим присмотром взрослого ответственного человека, чтобы обеспечить безопасную эксплуатацию устройства, а также понимание и избежание опасностей, связанных с его эксплуатацией.

⚠ **ПРЕДУПРЕЖДЕНИЕ** – Насос предназначен для непрерывной работы при максимальной температуре воды на 35°C.

⚠ **ПРЕДУПРЕЖДЕНИЕ** – Используйте только оригинальные запчасти компании «Hayward®».

⚠ **ПРЕДУПРЕЖДЕНИЕ** – Если шнур питания поврежден, то во избежание поражения электрическим током заменять его может лишь производитель, сервисный агент или специально обученный техник.

⚠ **ПРЕДУПРЕЖДЕНИЕ** – Для отсоединения от сетевого источника питания в стационарную электропроводку встраивается внешний выключатель с зазором между разомкнутыми контактами на всех полюсах, который обеспечивает полное отсоединение при перенапряжении III категории в соответствии с правилами по проводке.

⚠ **ПРЕДУПРЕЖДЕНИЕ** – Запрещается эксплуатировать насос для плавательного бассейн, если повреждены силовой кабель или корпус соединительной коробки электродвигателя. Это может привести к поражению электрическим током. Поврежденные шнур питания или соединительная коробка электродвигателя должны быть заменены сервисным агентом или аналогичным квалифицированным специалистом сразу же во избежание связанных угроз.

⚠ **ПРЕДУПРЕЖДЕНИЕ** – Электродвигатель для бассейна не оснащен предохранительной вакуумной системой (SVRS). Система SVRS помогает предотвращать затопление из-за нахождения тела на области подводных сливов. В некоторых бассейнах при попадании тела человека на слив, человек может попасть в ловушку из-за всасывания. В зависимости от конфигурации бассейна может потребоваться установка защитной вакуумной системы в соответствии с местными требованиями.

⚠ **ПРЕДУПРЕЖДЕНИЕ** – Этот насос содержит батарею, с которой по соображениям безопасности любые манипуляции должны выполняться авторизованной технической службой.

ИСПОЛЬЗУЙТЕ ТОЛЬКО ОРИГИНАЛЬНЫЕ ЗАПЧАСТИ КОМПАНИИ «HAYWARD®»

Поздравляем! Вы только что приобрели насос с регулируемой скоростью компании Hayward®.

Насосы с регулируемой скоростью компании Hayward® оснащены двигателем с постоянным магнитом и электронной коммутацией переменного тока последнего поколения. Управление данным двигателем осуществляет микропроцессор, подключенный к регулятору частоты, поддерживающему следующие характеристики:

- Отображение скорости вращения на контрольном экране
- Производителем предусмотрены 3 скорости вращения (кнопки V1, V2, V3), которые могут настраиваться пользователем
- Систематическая заливка при каждом запуске, скорость и продолжительность заливки являются настраиваемыми
- Функция Скиммера, снятие верхнего слоя воды
- Программируемая функция Таймера
- Отображение мгновенной потребляемой мощности
- Отображение общего и долевого энергопотребления
- Отображение времени работы насоса
- Низкий звуковой уровень
- Конструкционный стандарт TEFC IP55

Установить насос на достаточном расстоянии от бассейна для минимизации связи между системой аспирации и насосом с целью ограничения потерь на паразитную нагрузку и чрезмерных потерь в гидравлическом контуре.

При этом необходимо строго соблюдать расстояние, предусмотренное действующими нормами установки подобного оборудования (минимум 3.5 м). Установка и использование продукта на высоте менее 2000 м.

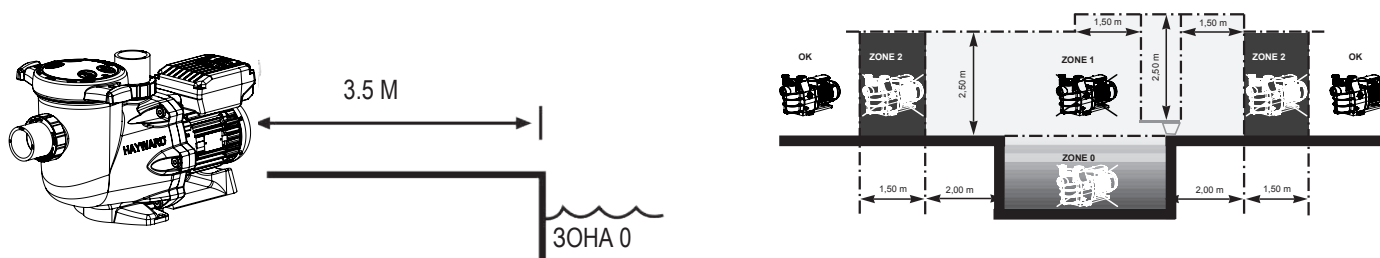

Установить насос в проветриваемом сухом месте; для естественной вентиляции двигателя необходимо обеспечить свободную циркуляцию воздуха вокруг него. Обеспечьте свободное пространство на расстоянии 0,5 м вокруг насоса. Необходимо периодически проверять, что охлаждению двигателя не препятствуют какие-либо объекты, листья и прочие предметы.

Монтаж насоса должен осуществляться таким образом, чтобы внешний автомат, встроенный в стационарный блок, был хорошо виден и легко доступен. Автомат должен находиться рядом с насосом.

Насос должен устанавливаться на стационарное бетонное основание при помощи натяжных болтов для бетона Ø 8 мм, завинчиваемых в предусмотренные монтажные отверстия. Во избежание ослабления натяжки натяжных болтов с течением времени необходимо предусмотреть стопорные шайбы. При необходимости монтажа насоса на деревянном полу использовать винты для дерева с шестигранной головкой Ø 8 мм, а также стопорные шайбы, препятствующие ослаблению натяжки с течением времени.

Установить насос в защищенном месте во избежание попадания на блок управления струй воды.

Уровень звукового давления насосов компании Hayward® составляет менее 70 дБ А.

Указания, подлежащие выполнению:

- Выполнить заземление насоса: Запрещено включать незаземленный насос.
- Подключить насос при помощи кабеля типа H07RN-F 3G1,5mm².
- Предусмотреть защитное устройство по дифференциальному току 30 мА, предназначенное для защиты людей от поражения электрическим током по причине нарушения электрической изоляции оборудования.
- Предусмотреть защиту от коротких замыканий (номинал определяется в зависимости от значений, приведенных на фирменной табличке двигателя).
- Предусмотреть устройство отключения от сети питания с межконтактным расстоянием (для всех полюсов), обеспечивающим полное размыкание в условиях 3-й категории перенапряжения.

⚠ ВНИМАНИЕ: После полного отключения насоса от электросети подождать не менее 5 минут перед проведением операций на двигателе или распределительной коробке: **Опасность поражения электротоком с возможным смертельным исходом.**

Для электродвигателей, которыми оснащены наши насосы, предусмотрена термическая защита, срабатывающая при перегрузках или перегреве обмотки двигателя. Данная защита производит возврат системы в исходное состояние после снижения температуры обмотки.

В соответствии с требованиями законодательства независимо от используемого типа двигателя помимо вышеперечисленных устройств необходимо предусмотреть термомангнитную защиту, откалиброванную в соответствии со значениями на фирменной табличке двигателя.

В таблице на стр. 169 приведены различные характеристики двигателя, которым оснащаются наши насосы.

ИСПОЛЬЗУЙТЕ ТОЛЬКО ОРИГИНАЛЬНЫЕ ЗАПЧАСТИ КОМПАНИИ «HAYWARD®»

Подключение к сети электропитания: Убедиться, что напряжение питания, требуемое для работы двигателя, соответствует напряжению сети, и что сечение и длина шнура питания соответствуют мощности и силе тока насоса.

Во избежание опасных ситуаций все электроподключения насоса, а также внесение изменений в шнур питания должен выполнять квалифицированный специалист.

Для выполнения электроподключений необходимо соблюдать маркировку, указанную под соединительными клеммами. Тщательно проверить качество затяжки и герметичность электрических соединений перед подачей напряжения питания.

Строго соблюдать последовательность прокладки кабеля через отверстие и специально предусмотренный магнитодиэлектрик; при этом сальник обеспечивает герметичность вокруг кабеля, а магнитодиэлектрик, представляет собой фильтр для электромагнитных помех.

Временную предварительную кабельную проводку, которой оснащены некоторые наши насосы, необходимо удалить при окончательном подключении насоса к источнику питания. На самом деле данное предварительное оборудование используется исключительно для проведения заводских испытаний на этапе изготовления.

УСТАНОВКА

Установить насос для бассейна, максимально ограничив потери нагрузки с соблюдением минимального расстояния в 3,5 м отнесения насоса от бассейна в соответствии со стандартом по монтажу. Аспирационный трубопровод должен устанавливаться с небольшим восходящим наклоном относительно оси насоса. Убедиться, что все патрубки тщательно затянуты и герметичны. В любом случае, не допускать чрезмерной затяжки данных трубопроводов. При использовании пластиковых материалов для обеспечения герметичности можно использовать исключительно тефлон. Аспирационная труба должна иметь больший или по крайней мере такой же диаметр, как и отводная. Избегать влажных мест с плохой вентиляцией. Для охлаждения двигателя необходима свободная циркуляция воздуха вокруг него. Установить насос в защищенном месте во избежание попадания на блок управления струй воды.

ВАЖНО: Проверить направление вращения перед окончательным подключением двигателя.

УКАЗАНИЯ ПО ЗАПУСКУ И ВХОДУ В РАБОЧИЙ ЦИКЛ: Заполнить корпус префильтра водой до уровня аспирационной трубы. Запрещено запускать насос без воды, она необходима для охлаждения и смазки механического затвора. Открыть все клапаны аспирационных и отводных трубопроводов, а также клапан стравливания воздуха из фильтра, если таковой предусмотрен. (Необходимо полностью удалить воздух из аспирационных трубопроводов.) Запустить агрегат и подождать некоторое время до входа в рабочий цикл. Пять минут не считается слишком большим интервалом времени для входа в рабочий цикл (процесс входа в рабочий цикл зависит от высоты аспирационной системы и длины аспирационной трубы). Если насос не запускается или не входит в рабочий цикл, см. руководство по поиску и устранению неисправностей.

ИСПОЛЬЗОВАНИЕ ПУЛЬТА УПРАВЛЕНИЯ

1. ОПИСАНИЕ

Насос с регулируемой скоростью Hayward® управляется пультом, который позволяет отображать и настраивать эксплуатационные параметры, а также программировать режим Таймера.

1	Светодиодная сигнальная лампа подключения под напряжение
2	LCD-экран
3	Выбор скорости
4	Рычаг переключения между Ручным режимом/режимом Таймер
5	Кнопки настройки вверх/вниз
6	Кнопки Запуска/Останова
7	Кнопка отображения параметров
8	Светодиодные сигнальные лампы для выбранной скорости

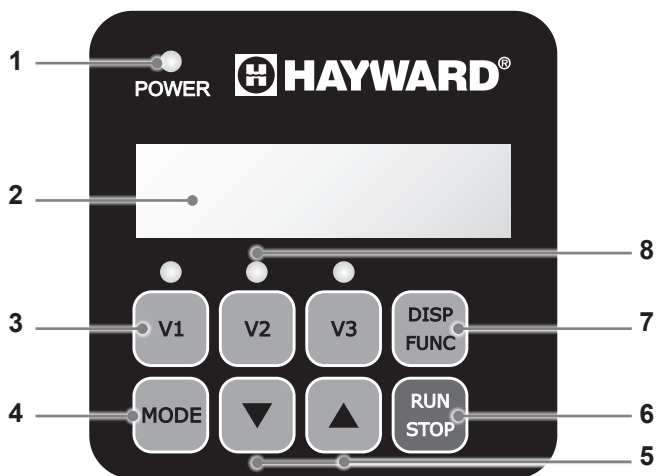

Насос поставляется с **УСТАНОВЛЕННЫМИ ПО УМОЛЧАНИЮ ПАРАМЕТРАМИ** (заводские настройки):

Заливка продолжительность (с)	Заливка скорость (об/мин)	V1 (об/мин)	V2 (об/мин)	V3 (об/мин)	Скиммер продолжительность (мин)	Скиммер цикл (ч)	Скиммер скорость (об/мин)
240	3000	1500	2400	3000	15	1ч	2800

об/мин: Оборотов в минуту

ИСПОЛЬЗУЙТЕ ТОЛЬКО ОРИГИНАЛЬНЫЕ ЗАПЧАСТИ КОМПАНИИ «HAYWARD®»

2. РЕЖИМЫ РАБОТЫ НАСОСА

2.1 Ручной режим

В Ручном режиме, в зависимости от использования бассейна, пользователь вручную запускает или останавливает насос.

- Запуск насоса переводит его в состояние заливки (a). Данное состояние является настраиваемым (скорость и продолжительность, § 4.2). Заливку можно остановить при запуске (§ 3.2) или отключить в настройках.
- Затем скорость стабилизируется до постоянного значения (b) (по умолчанию до скорости V2). Данная скорость может выбираться и устанавливаться пользователем (§ 3.3).
- После остановки/повторного запуска насос стабилизируется до последней запомненной скорости.

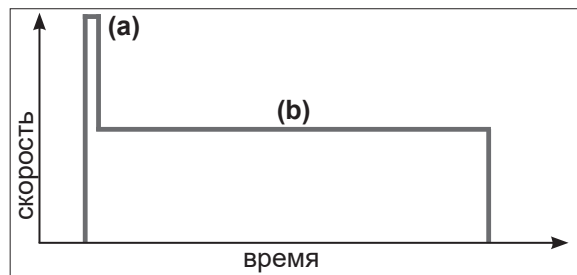

2.2 Скиммер

Функция Скиммера позволяет снимать верхний слой воды и избегать накопления, а также застоя загрязнений на поверхности бассейна.

- Данная функция является автоматической: насос работает на повышенной скорости (c), в соответствии с установленными временем и циклом.
- Вне работы на повышенной скорости, насос выходит на номинальную скорость, как при управлении в Ручном режиме, так и в режиме Таймера.
- Функция Скиммера может быть отключена (см. настройки § 4.3).

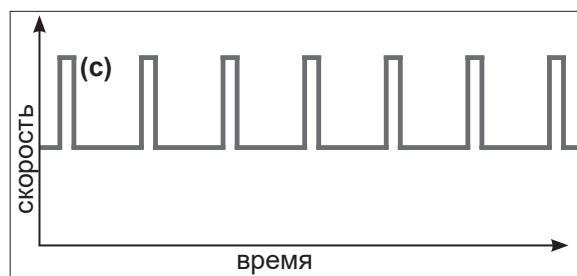

2.3 Режим Таймера

В режиме Таймера работа насоса круглосуточно (24/24) автоматизирована. Пользователь может запрограммировать различные последовательности включения скоростей (d). Они выбираются в зависимости от установки оборудования (режим нагрева, энергосберегающее устройство и т.д.) и графика использования бассейна.

- Если функция Скиммера включена, она добавляется в данные последовательности выполнения управляющей программы.
- Насос может быть остановлен (поставлен на паузу) в режиме Таймера. При повторном запуске скорость будет соответствовать текущей в режиме Таймера.
- Для программирования режима Таймера смотрите § 4.5.

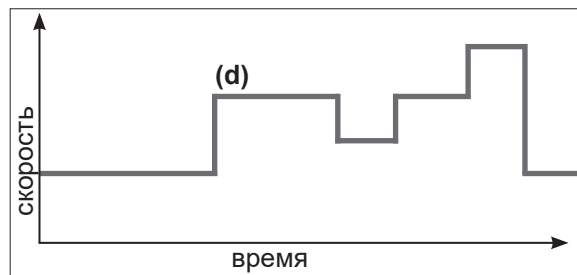

2.4 Рычаг переключения между Ручным режимом/режимом Таймера

Смена режима выполняется при нажатии на кнопку **MODE**, как показано ниже:

Ручной режим

Отображение скорости без приставки

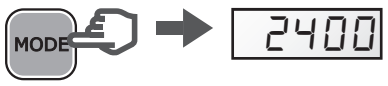

Горящий светодиод указывает на выбранную скорость (V2 по умолчанию)



Режим Таймера

Отображение скорости с приставкой «t»



Светодиоды не горят

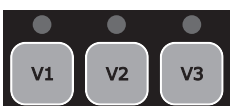

ИСПОЛЬЗУЙТЕ ТОЛЬКО ОРИГИНАЛЬНЫЕ ЗАПЧАСТИ КОМПАНИИ «HAYWARD®»

2.5 Подключение внешних цифровых входов

⚠ ВНИМАНИЕ! Любые электрические работы на насосе выполняйте только спустя 5 мин после его отключения от электросети.

Фильтрационный насос оснащен 5-проводным 3-метровым кабелем для соединения четырех цифровых входов или сухих контактов без потенциала (Разомкнутое/Замкнутое).

Примеры использования цифровых входов

- Установите скорость и расход, который требуется для надлежащей работы периферийных устройств, таких как тепловой насос, откатывающийся роллет или нагнетательный автомат и т. д.
- Установите вызов команд для пользовательского интерфейса. Данные цифровые входы позволяют управлять на расстоянии трех метров функцией Run/Stop, а также тремя скоростями (V1-V2-V3).

Назначение проводов		
D11	Коричневый	Скорость V1
D12	Зеленый	Скорость V2
D13	Белый	Скорость V3
D14	Красный	Run/Stop
C	Черный	Общий

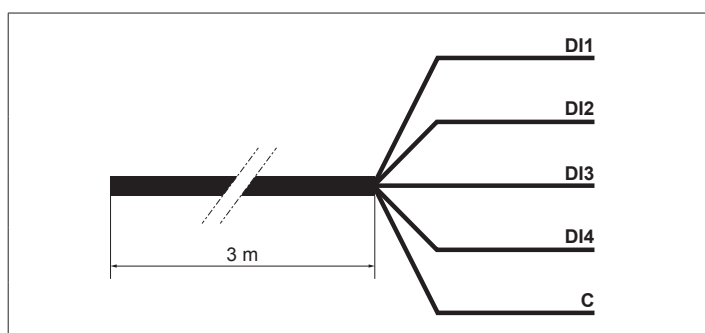

Примечание:

- При частичном использовании цифровых входов неиспользуемые провода должны быть электроизолированы.
- Если цифровые входы не используются, установите на место соединитель (A), а также 5-проводной кабель (см. рисунок ниже).

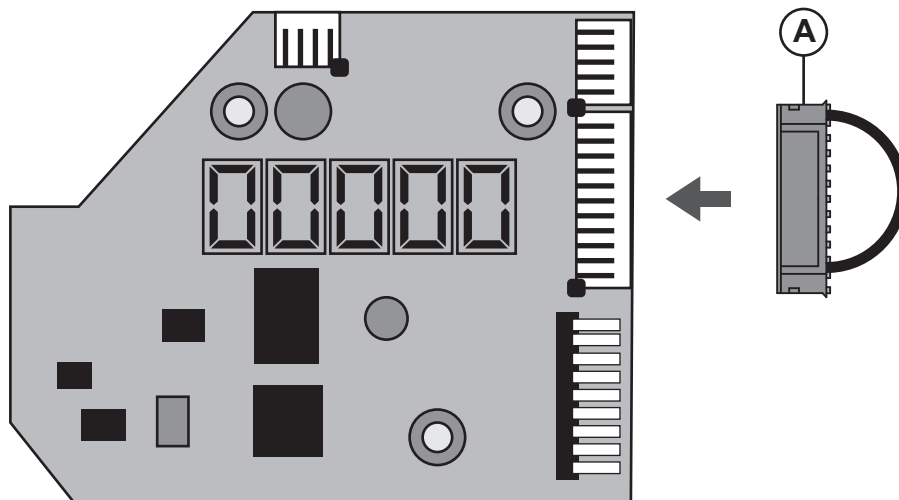

ИСПОЛЬЗУЙТЕ ТОЛЬКО ОРИГИНАЛЬНЫЕ ЗАПЧАСТИ КОМПАНИИ «HAYWARD®»

Работа с цифровыми входами

<p>Цифровые входы могут использоваться в Ручном режиме и в режиме Таймера. Они имеют самый высокий уровень приоритета и являются ГЛАВНЫМИ для всех текущих используемых функций. Только кнопки Run/Stop и DISP/FUNC остаются активными.</p>	<p>→ </p> <p>→ </p>
<p>При использовании цифрового входа соответствующий скорости светодиод начинает быстро мигать (DI1 = V1, DI2 = V2 или DI3 = V3).</p>	<p>→ </p>

<p>Для выполнения действия посредством цифровых входов вход DI4 должен быть замкнут.</p>	<p>→ DI4 Run/StopЗамкнутый</p>			
<p>Если несколько цифровых входов переключаются одновременно, работать будет только один из них в порядке очередности, установленной в таблице справа.</p>		DI1 = V1	DI2 = V2	DI3 = V3
	DI1 = V1	V1	V2	V3
	DI2 = V2	V2	V2	V3
	DI3 = V3	V3	V2	V3

Примечание: После того, как действие, связанное с цифровым входом, закончено (контакт разомкнут), фильтрационный насос возобновляет действие текущего режима работы.

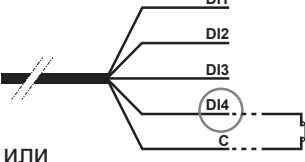
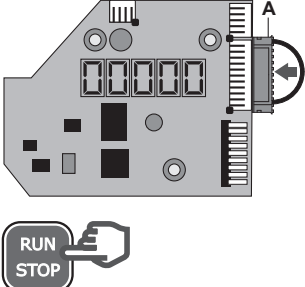
<p>Если цифровой вход ЦВХ 4 (DI4) открыт, фильтрационный насос не запускается и на дисплее насоса появляется надпись dSTOP.</p> <ul style="list-style-type: none"> • закрыть вход ЦВХ 4 (DI4) • необходимости нажать на RUN/STOP для запуска фильтрационного насоса. 	<p>→ </p>
	<p>→ </p> <p>ИЛИ</p>
	<p>→ </p>

ИСПОЛЬЗУЙТЕ ТОЛЬКО ОРИГИНАЛЬНЫЕ ЗАПЧАСТИ КОМПАНИИ «HAYWARD®»







3. ЭКСПЛУАТАЦИЯ

3.1 Включение под напряжение



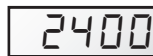
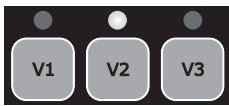



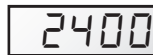
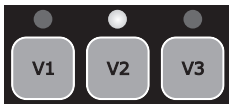

Загорается сигнальная лампочка «Power»; на экране выполняется тестирование LCD, затем отображается версия программного обеспечения		→		→	
--	---	---	---	---	---

3.2 Состояние заливки

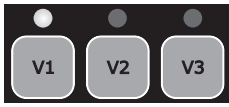
После включения насоса под напряжение выполняется автоматический переход в состояние заливки (то же самое при повторном запуске насоса).



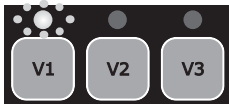
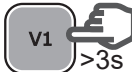



Автоматический переход в состояние заливки: • Скорость увеличивается до 3000 об/мин и поддерживается в течение 240 с (значения по умолчанию)		→		
Завершение заливки: • По умолчанию скорость стабилизируется до V2 или последней запомненной скорости • Загорается соответствующий светодиод (Ручной режим)		→		
Для отображения оставшегося времени заливки: • Нажмите на «DISP/FUNC» • Оставшееся время отображается в с		→		
Для выхода перед завершением заливки: • Нажмите на «RUN/STOP» • По умолчанию скорость стабилизируется до V2 или последней запомненной скорости		→		

3.3 В Ручном режиме: выбор, настройка и запоминание скорости

Для выбора скорости: • Нажмите на одну из кнопок скоростей • Отобразится значение по умолчанию (в об/мин) • Загорится соответствующий светодиод		→		
Для установки нового значения скорости: • Нажмите на кнопки настройки вверх/вниз • Светодиод начнет мигать: настройка запущена • Установите требуемое значение (от 600 до 3000 об/мин)	 	→		
Для сохранения нового значения скорости: • Удерживайте в течение 3 с кнопку скорости • Когда значение скорости запомнится, светодиод перестанет мигать и будет гореть постоянно	 >3s	→		

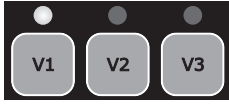
Примечание: Расход воды, связанный со скоростью насоса, должен быть адаптирован по отношению к мощности установки (фильтр, коммуникации и др.). По всем вопросам обращайтесь к специалистам.

3.4 Останов/повторный запуск насоса

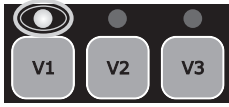
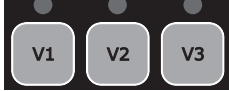







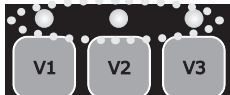

Для останова насоса: • Нажмите на «RUN/STOP» • Насос остановится, светодиод скорости останется гореть • В Ручном режиме экран будет отображать постоянно горящую надпись «StoP» В режиме Таймера экран будет отображать мигающую надпись «StoP»		→	 	
Для повторного запуска насоса: • Нажмите на «RUN/STOP» • Насос запустит состояние заливки (§ 3.2) • Скорость стабилизации: в Ручном режиме – последняя запомненная скорость, в режиме Таймера - текущая скорость режима Таймера		→	 → 	 

ИСПОЛЬЗУЙТЕ ТОЛЬКО ОРИГИНАЛЬНЫЕ ЗАПЧАСТИ КОМПАНИИ «HAYWARD®»

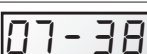
4. НАСТРОЙКИ

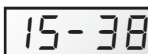











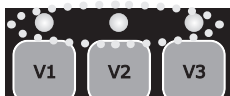

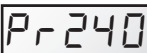
Примечание: Для доступа к настройкам насос должен находиться под напряжением и в Ручном режиме (§ 2.4), при останове или работе вне состояния заливки.
Если никакая кнопка не будет нажата в течение 2 мин, вернется отображение исходного информационного окна (скорость или «StoP») и настройки не сохранятся.

4.1 Установка времени

<ul style="list-style-type: none"> Удерживайте в течение 3 с «DISP/FUNC» Начнут мигать 3 светодиода На экране отобразится «ConF», затем «hr» 	  	
<ul style="list-style-type: none"> Нажмите на «DISP/FUNC» для отображения времени системных часов (чч-мин) на экране 	 	
<ul style="list-style-type: none"> Нажмите на кнопки настройки вверх/вниз для установки часов/минут 	   	
<ul style="list-style-type: none"> Нажмите на «RUN/STOP» для выхода и сохранения На экране отобразится текущая скорость или «StoP» 	 	

Примечание: Настройка системных часов необходима при работе в режиме Таймера.
Она запомнится, если насос будет находиться под напряжением.

4.2 Настройка заливки

<ul style="list-style-type: none"> Удерживайте в течение 3 с «DISP/FUNC» Начнут мигать 3 светодиода, и на экране отобразится «ConF» 	 	
<ul style="list-style-type: none"> Нажмите на «DISP/FUNC» n раз до появления на экране «Pr 240» значения продолжительности заливки по умолчанию (с) 	 	
<ul style="list-style-type: none"> Нажмите на кнопки настройки вверх/вниз для отображения требуемого значения продолжительности заливки (от 0 с до 300 с) 	  	
<ul style="list-style-type: none"> Нажмите на «DISP/FUNC»: на экране отобразится «03000» скорость заливки по умолчанию (об/мин) 	 	
<ul style="list-style-type: none"> Нажмите на кнопки настройки вверх/вниз для отображения требуемого значения (максимум 3000 об/мин) 	  	
<ul style="list-style-type: none"> Нажмите на «RUN/STOP» для выхода и сохранения На экране отобразится текущая скорость или «StoP» 	 	

Примечание: Если продолжительность заливки равна нулю, на экране отобразится «ProFF»: заливка **отключена**





ИСПОЛЬЗУЙТЕ ТОЛЬКО ОРИГИНАЛЬНЫЕ ЗАПЧАСТИ КОМПАНИИ «HAYWARD®»

4.3 Настройка функции Скиммера

См. § 2.2 с описанием данной функции

<ul style="list-style-type: none"> Удерживайте в течение 3 с «DISP/FUNC» Начнут мигать 3 светодиода, и на экране отобразится «ConF» 	 >3s	→		
<ul style="list-style-type: none"> Нажмите на «DISP/FUNC» n раз до появления на экране «SFO.15»: время включения Скиммера по умолчанию (в минутах) 	 x n	→		
<ul style="list-style-type: none"> Нажмите на кнопки настройки вверх/вниз для отображения требуемой продолжительности (от 0 до 30 мин) 		→		
<ul style="list-style-type: none"> Нажмите на «DISP/FUNC»: на экране отобразится «St 1h»: продолжительность цикла Скиммера по умолчанию 		→		
<ul style="list-style-type: none"> Нажмите на кнопки настройки для регулировки цикла Скиммера 1 ч, 2 ч или 3 ч 		→		
<ul style="list-style-type: none"> Нажмите на «DISP/FUNC»: на экране отобразится «S2800»: скорость Скиммера по умолчанию (об/мин) 		→		
<ul style="list-style-type: none"> Нажмите на кнопки настройки вверх/вниз для отображения требуемой скорости (от 600 до 3000 об/мин) 		→		
<ul style="list-style-type: none"> Нажмите на «RUN/STOP» для выхода и сохранения; На экране отобразится текущая скорость или «StoP» 		→		
Примечание: Для отключения Скиммера, установите продолжительность равную нулю - На экране появится «SFoFF»		→		

4.4 Сброс параметров

Для восстановления параметров по умолчанию и удаления настроек режима Таймера выполните следующее:

<ul style="list-style-type: none"> Удерживайте в течение 3 с «DISP/FUNC» Начнут мигать 3 светодиода, и на экране отобразится «ConF» 	 >3s	→			
<ul style="list-style-type: none"> Нажмите на «DISP/FUNC» n раз до появления сообщения «Init» на экране 	 x n	→			
<ul style="list-style-type: none"> Удерживайте кнопку настройки «haut» в течение 3 с. На экране появится «done», когда сброс параметров будет выполнен. 	 >3s	→		→	

Напоминание: параметры по умолчанию и диапазон настроек

	Заливка		Кнопки скорости			Функция Скиммера			Функция Таймера			
	P _r	σ ₋₋₋	V1	V2	V3	S _F	S _t	S ₋₋₋	t ₀	t ₁	t ₅	
Единица измерения	с	об/мин	об/мин	об/мин	об/мин	мин	ч	об/мин	чч-мин	об/мин	чч-мин	об/мин
По умолчанию	240	3000	1500	2400	3000	15	1	2800	06-00	2400	σFF	0
Mini	0 (σFF)	600	600	600	600	0 (σFF)	1 ...	600	00-00	—	00-00	0/ 600
Maxi	300	3000	3000	3000	3000	30	... 3	3000	24-00	—	24-00	3000

ИСПОЛЬЗУЙТЕ ТОЛЬКО ОРИГИНАЛЬНЫЕ ЗАПЧАСТИ КОМПАНИИ «HAYWARD®»

4.5 Программирование режима Таймера

Пульт управления позволяет запрограммировать несколько последовательностей выполнения управляющей программы (см. § 2.3) или Таймеры t0-t5, которым необязательно быть в хронологической последовательности.

Неиспользуемые Таймеры будут отключены. Таймер «t0» может быть установлен на 00:00, 06:00 (по умолчанию); 12:00 или 18:00. Он не может быть отключен. Скорость насоса на промежутке t0 остается постоянной и составляет 2400 об/мин

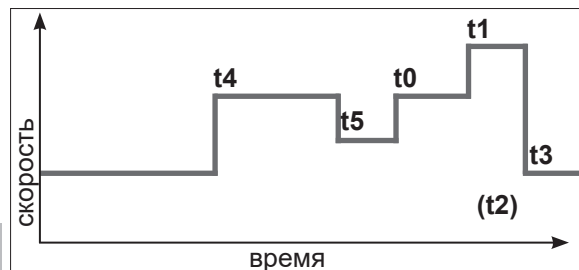



- Укажите график скорости для программирования. На графике напротив представлен пример.
- Проверьте правильность: настройки системных часов.

<ul style="list-style-type: none"> • Удерживайте в течение 3 с «DISP/FUNC» Начнут мигать 3 светодиода, и на экране отобразится «ConF» 						
<ul style="list-style-type: none"> • Нажмите на «DISP/FUNC» 2 раза до появления на экране «t0» 						
<ul style="list-style-type: none"> • Нажмите на «DISP/FUNC» и на экране отобразится «06-00»: значение t0 по умолчанию 						
<ul style="list-style-type: none"> • Нажмите на кнопки настройки для установки требуемого значения t0 (00-00, 06-00, 12-00 или 18-00) 						
<ul style="list-style-type: none"> • Нажмите на «DISP/FUNC»: на экране отобразится «t1off» 						
<ul style="list-style-type: none"> • Чтобы включить (например) данный Таймер, нажмите на кнопку «haut». На экране отобразится «t1 on» 						
<ul style="list-style-type: none"> • Нажмите на «DISP/FUNC»: на экране отобразится «00-00» 						
<ul style="list-style-type: none"> • Нажмите на кнопки настройки вверх/вниз для настройки необходимого времени (чч/мин) 						
<ul style="list-style-type: none"> • Нажмите на «DISP/FUNC»: на экране отобразится «0» 						
<ul style="list-style-type: none"> • Нажмите на кнопки настройки, чтобы отобразить требуемую скорость (от 600 до 3000 об/мин или ноль) 						
<ul style="list-style-type: none"> • Для перехода к следующему Таймеру нажмите на «DISP/FUNC»: на экране отобразится «t2off». В примере данный Таймер остается отключенным 						
<ul style="list-style-type: none"> • Нажмите на «DISP/FUNC» для перехода к следующему Таймеру и повторите этапы настройки (включение, график Таймера и скорость) 				etc ...		
<ul style="list-style-type: none"> • Нажмите на «RUN/STOP» для выхода и сохранения На экране отобразится текущая скорость или «StoP» 						

ИСПОЛЬЗУЙТЕ ТОЛЬКО ОРИГИНАЛЬНЫЕ ЗАПЧАСТИ КОМПАНИИ «HAYWARD®»

5. ВИЗУАЛИЗАЦИЯ ПАРАМЕТРОВ

Примечание: Насос должен быть под напряжением, в работе вне состояния заливки или при останове. Для просмотра параметров нажмите на клавишу «DISP/FUNC». Если в течение 15 с не была нажата никакая кнопка, экран переходит к отображению исходного информационного окна (текущая скорость или «Stop»).

<ul style="list-style-type: none"> Нажмите на «DISP/FUNC»: на экране отобразится «hr». Повторно нажмите: отобразятся системные часы 	 → hr  → 11-45
<ul style="list-style-type: none"> Нажмите на «DISP/FUNC»: на экране отобразится «t0». Повторно нажмите: отобразится график t0 (скорость t0 является постоянной и составляет 2400 об/мин) 	 → t0  → 12-00
<ul style="list-style-type: none"> Нажмите на «DISP/FUNC»: на экране отобразится «t1». Повторно нажмите: отобразится график данного Таймера (чч/мин) 	 → t1  → 09-20
<ul style="list-style-type: none"> Нажмите на «DISP/FUNC»: отобразится скорость данного таймера (в об/мин) 	 → 1240
<ul style="list-style-type: none"> Нажмите на «DISP/FUNC» и т.д.: появятся следующие таймеры, график и скорость, до Таймера «t5» <p>Примечание: Отключенные Таймеры не отображаются на экране</p>	 → t2 etc ...
<ul style="list-style-type: none"> Нажмите на «DISP/FUNC»: отобразится «P - - -» Потребляемая мощность (в Вт, значение +/- 10%) <p>Примечание: P = 0 Вт при останове насоса</p>	 → P 634 / P 0
<ul style="list-style-type: none"> Нажмите на «DISP/FUNC»: отобразится «h - - -» Счетчик времени насоса <p>Примечание: Один оборот счетчика составляет 9999 ч</p>	 → h2857
<ul style="list-style-type: none"> Нажмите на «DISP/FUNC»: отобразится «- - - -» Общее энергопотребление (кВт/ч) <p>Примечание: Один оборот счетчика составляет 99999 кВт/ч</p>	 → 06542
<ul style="list-style-type: none"> Нажмите на «DISP/FUNC»: отобразится «- - - -» Долевое энергопотребление (кВт/ч) с момента последнего сброса на ноль 	 → 00086
<ul style="list-style-type: none"> Для обнуления долевого счетчика энергии: Удерживайте в течение 3с одну из кнопок вверх/вниз. Сообщение «CLEAR» информирует о сбросе счетчика на ноль 	  → CLEAR >3s
<ul style="list-style-type: none"> Нажмите на «DISP/FUNC»: Отобразится «SF On» или «SFOFF» для включенного/отключенного Скиммера 	 → SF On / SFOFF
<ul style="list-style-type: none"> Нажмите на «DISP/FUNC»: Отобразится «t - -» Температура блока питания (°C) 	 → t 74
<ul style="list-style-type: none"> Нажмите на «DISP/FUNC» для возврата отображения исходного информационного окна (текущая скорость или «Stop») 	 → 1640 / Stop t2400 / Stop

ИСПОЛЬЗУЙТЕ ТОЛЬКО ОРИГИНАЛЬНЫЕ ЗАПЧАСТИ КОМПАНИИ «HAYWARD®»

ТЕХНИЧЕСКОЕ ОБСЛУЖИВАНИЕ

1. Полностью отключите насос от источника питания перед открытием крышки и очисткой префильтра. Периодически выполнять очистку поддона префильтра, не стучать по нему при этом. Проверить прокладку крышки префильтра и при необходимости заменить.
2. Ось двигателя устанавливается на необслуживаемых подшипниках.
3. Поддерживать двигатель в чистом сухом состоянии и проверять вентиляционные отверстия на наличие загрязнений.
4. При возникновении утечки на уровне механического затвора выполнить его замену.
5. Все операции по ремонту, техобслуживанию и периодическому обслуживанию, за исключением очистки бассейна, должен в обязательном порядке выполнять уполномоченным представителем компании Hayward® или квалифицированный специалист.

Упомянутые ниже изнашиваемые детали насоса следует обслуживать в соответствии с расчетным сроком службы:

Расчетный срок изнашиваемых частей:

Стопор и гнездо стопора	1 ГОД
Комплект подшипников двигателя	1 ГОД
Комплект прокладок (предварительный фильтр, корпус, фитинги, слив)	2 ГОДА
Колодка подключения	2 ГОДА

КОНСЕРВАЦИЯ НА ЗИМНИЙ ПЕРИОД

1. Опорожнить насос, сняв все сливные пробки и сложив их в поддон префильтра.
2. Отключить насос, снять все трубопроводные патрубки и поместить весь агрегат в сухое хорошо проветриваемое помещение или по крайней мере принять следующие меры: отключить насос, снять 4 болта крепления корпуса насоса к суппорту двигателя и поместить систему на хранение в сборе в сухое проветриваемое место. Накрыть корпус насоса и префильтра в целях их защиты.

ПРИМЕЧАНИЕ: Перед возвратом насоса в эксплуатацию провести очистку всех внутренних частей, удалив с них пыль, налет и пр.

ВОЗМОЖНЫЕ НЕИСПРАВНОСТИ И СПОСОБЫ ИХ УСТРАНЕНИЯ

А) Двигатель не запускается

1. Проверить электрические подключения, автоматы и реле, а также прерыватели или плавкие предохранители.
2. Вручную проверить свободное вращение двигателя.
3. Убедиться, что скорости вращения V2 и V3 запрограммированы не на 0 об./мин., в противном случае выполнить восстановление заводских настроек (см. § 4.4).
4. При появлении на экране одного из нижеуказанных кодов ошибки свяжитесь со специалистом по установке оборудования:

Eerr01 Понижение напряжения от заданного уровня

Eerr02 Повышение напряжения от заданного уровня

Eerr04 Перегрев блока питания

Eerr05 Перегрев двигателя

Eerr07 Ток перегрузки

Eerr10 Проблема внутреннего электропитания

Eerr20 Неудачный запуск

Eerr64 Внутреннее короткого замыкания

Eerr97 Несколько проблем

Eerr98 Коммуникационный сбой

d5toP Обратитесь к странице 160

В) Двигатель останавливается, проверить

1. Кабели, соединения, реле и пр.
2. Падение напряжения на двигателе (зачастую по причине слишком слабых кабелей).
3. Отсутствие заклинивания или перегрузки (проверив значение потребляемого тока).

ПРИМЕЧАНИЕ: Двигатель Вашего насоса оснащен термозащитой, которая в случае перегрузки автоматически разомкнет цепь во избежание повреждения двигателя. Такое срабатывание вызвано нехарактерными условиями эксплуатации, необходимо проверить причины и устранить их. Двигатель перезапустится без проведения каких-либо операций обслуживания после восстановления нормальных условий эксплуатации.

С) На дисплее появляется «OLOAD» (проблема перегрузки или перегрева)

1. Убедиться, что вал двигателя вращается свободно
2. Убедиться в отсутствии каких-либо препятствий свободному вращению турбины

ИСПОЛЬЗУЙТЕ ТОЛЬКО ОРИГИНАЛЬНЫЕ ЗАПЧАСТИ КОМПАНИИ «HAYWARD®»

3. Убедиться в достаточной вентиляции двигателя
4. После устранения проблемы нажмите кнопку запуска/останова

D) Насос не входит в рабочий цикл

1. Убедиться, что корпус префильтра заполнен водой, а прокладка крышки чиста и расположена правильно, препятствуя попаданию воздуха. При необходимости перезатянуть стопорные винты крышки.
2. Убедиться, что все клапаны аспирационных и отводных трубопроводов открыты и незасорены, а все аспирационные отверстия бассейна находятся под водой.
3. Проверить, выполняет ли насос всасывание, разблокировав аспирационное отверстие, расположенное как можно ближе к насосу:
 - а) если насос не выполняет всасывание, несмотря на достаточное заполнение водой для входа в рабочий цикл
 1. Перезатянуть болты и трубопроводные фитинги со стороны аспирации.
 2. Проверить напряжение, чтобы убедиться, что насос вращается на достаточной скорости.
 3. Открыть насос и убедиться, что внутри нет засора.
 4. Установите достаточную скорость заливки
 5. Очистите фильтр и повторите операцию
 6. Заменить механический затвор.
 - б) Попробуйте выполнить заливку в режиме рециркуляции. При нормальном всасывании насоса проверить аспирационный трубопровод и префильтр, которые могут засориться или в которые может попасть воздух.

F) Насос издает шум, проверить

1. Не привело ли попадание или наличие воздуха в аспирационной системе к появлению глухих шумом в насосе.
2. Не происходит ли разрыв потока вследствие недостаточного диаметра или сужения аспирационного трубопровода. Кроме того, причиной подобного разрыва потока может стать слишком большой размер отводного трубопровода. Используйте трубы соответствующих размеров или при необходимости проведите их продувку.
3. Не появилась ли вибрация, вызванная некачественным монтажом.
4. Не попал ли в корпус насоса посторонний предмет.
5. Не произошло ли заклинивание подшипников двигателя вследствие слишком большого зазора, коррозии или длительного перегрева.

GUIDE TECHNIQUE DE LA POMPE - TECHNICAL GUIDE FOR THE PUMP - GUÍA TÉCNICA PARA LA BOMBA - MANUAL TÉCNICO DA BOMBA - TECHNISCHE ANLEITUNG FÜR DIE PUMPE - TECHNISCHE GIDS VOOR DE POMP - GUIDA TECNICA PER LA POMPA - TEKNISK GUIDE FÖR PUMPEN - TEKNISK GUIDE TIL PUMPEN - TEKNISK VEILEDNING FOR PUMPEN - PUMPUN TEKNINEN OPAS - ТЕХНИЧЕСКОЕ РУКОВОДСТВО ПО НАСОСУ

Pompe	Référence moteur	Puissance nominale	Voltage Fréquence Nb de phases	Ampérage	Taille et réglage disjoncteur	Hauteur manométrique à débit=0
Pump	Motor reference	Nominal power	Voltage Frequency Number of phases	Amperage	Circuit breaker size and setting	Manometric head at flow = 0
Bomba	Referencia motor	Potencia nominal	Voltaje Frecuencia Número de fases	Amperaje	Tamaño y ajuste disyuntor	Altura manométrica de caudal=0
Bomba	Referência do motor	Potência nominal	Tensão Frequência Número de fases	Amperagem	Tamanho e regulação do disjuntor	Altura manométrica para caudal = 0
Pumpe	Motorreferenz	Nennleistung- saufnahme	Voltzahl Frequenz Phasenanzahl	Stromstärke	Größe und Einstellung Sicherung	Druckhöhe bei Durchfluss=0
Pomp	Motorreferentie	Nominaal vermogen	Spanning Frequentie Aantal fases	Stroomsterkte	Grootte en instelling beveiligingsschakelaar	Opvoerhoogte bij doorstroming=0
Pompa	Riferimento motore	Potenza nominale	Voltaggio Frequenza Numero fasi	Amperaggio	Dimensione e regolazione interruttore differenziale	Altezza manometrica a capacità=0
Pump	Motorns referens	Märkeffekt	Spänning Frekvens Ant. faser	Strömstyrka	Brytarens storlek och justering	Manometrisk uppfordringshöjd vid flöde = 0
Pumpe	Motor reference	Nominal effekt	Spænding Frekvens Ant. faser	Strømstyrke	Størrelse og indstilling af kontakt	Dynamisk løftehøjde med flow =0
Pumpe	Referanse motor	Merkeeffekt	Spenning Frekvens Antall faser	Strømstyrke	Størrelse og innstilling skillebryter	Manometrisk høyde med ytelse=0
Pumppu	Viite moottori	Nimellisteho	Jännite Taajuus Vaiheiden lukumäärä	Ampeerit	Katkaisimen koko ja säätö	Dynaaminen paine virtaamalla=0
Насос	Артикул двигателя	Номин. потр. мощность	Напряжение Частота Кол-во фаз	Сила тока	Размер и настройка разъединителя	Манометрическая высота при расходе=0
SP3216VSTD	SPX1100SFVSTD(SB)	1100 W	220-240Vl 50 Hz 1 Phase	5.9 A	6.5	19 M
SP3220VSTD	SPX1500SFVSTD(SB)	1400 W	220-240Vl 50 Hz 1 Phase	7.8 A	10	18 M
SPK12615VSTD	SPX1100KFVSTD(SB)	1100 W	220-240Vl 50 Hz 1 Phase	5.9 A	6.5	16 M
RS3016VSTD	SPX1100VSTD(SB)	1100 W	220-240Vl 50 Hz 1 Phase	5.9 A	6.5	17.9 M
RS3020VSTD	SPX1500VSTD(SB)	1400 W	220-240Vl 50 Hz 1 Phase	7.8 A	10	19.6 M
SP2310VSTD	SPX0750SFVSTD(SB)	750 W	220-240Vl 50 Hz 1 Phase	4.4 A	4.7	14 M
SP2315VSTD	SPX1100SFVSTD(SB)	1100 W	220-240Vl 50 Hz 1 Phase	5.9 A	6.5	16 M
SP2611VSTD	SPX1100SFVSTD(SB)	750 W	220-240Vl 50 Hz 1 Phase	4.4 A	4.7	14 M
SP2616VSTD	SPX1100VSTD(SB)	1100 W	220-240Vl 50 Hz 1 Phase	5.9 A	6.5	16 M

TRISTAR VSTD SERIES

SP3216VSTD

SP3220VSTD

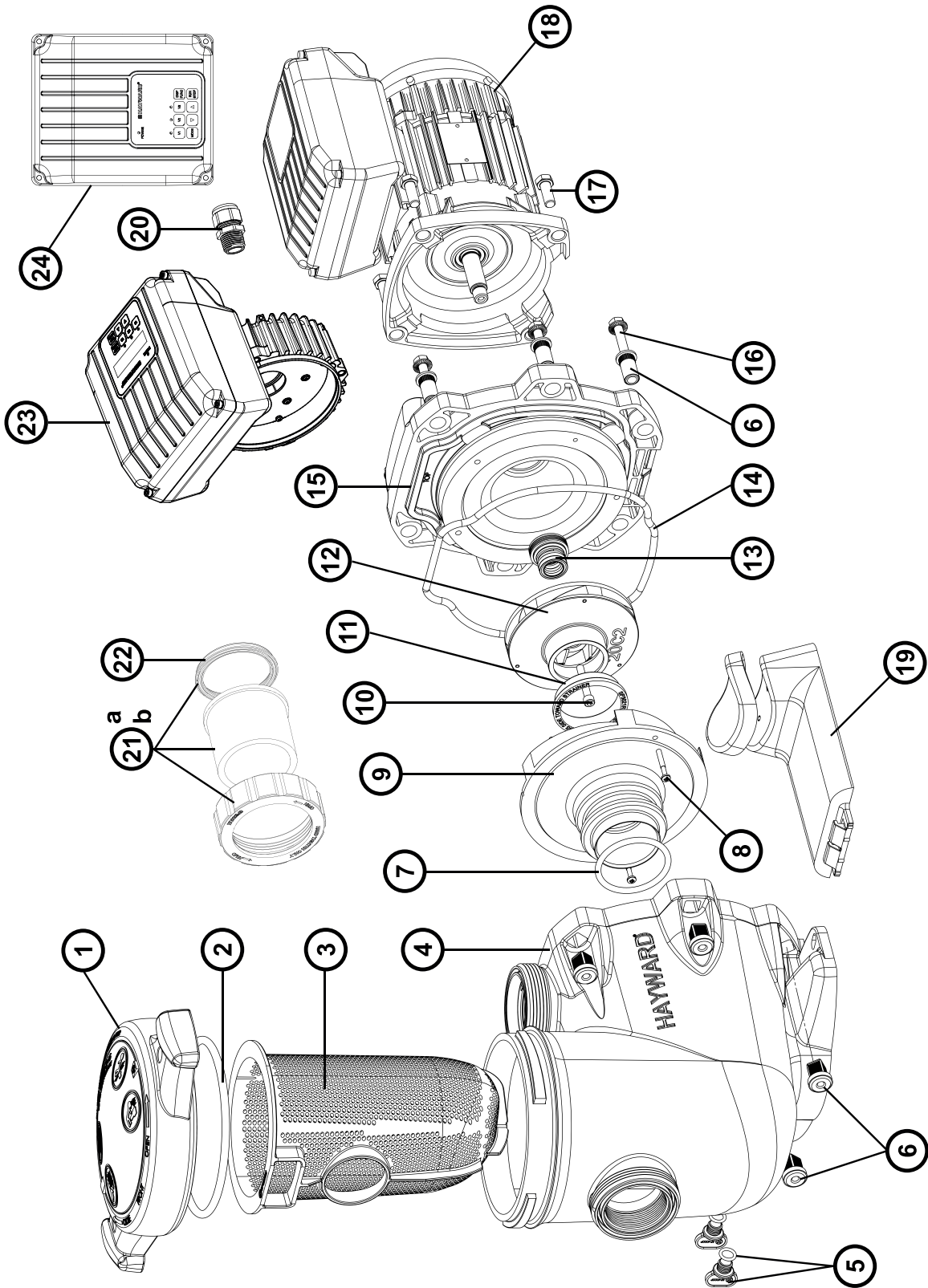

N°	Description · Description · Descripción · Descrição · Bezeichnung · Beschrijving · Descrizione · Beskrivning · Beskrivelse · Beskrivelse · Kuvaus · Описание
1	Strainer cover · Couverture de préfiltre · Tapa de prefiltro · Tampa do filtro · Deckel · Zeef dekking · Coperchio prefiltro · Silskydd · Sildeksel · Si dæksel · Siivilä kansi · Крышка префильтра
2	Strainer cover O-Ring · Joint torique de préfiltre · Junta tórica · Junta tórica da tampa do filtro · O-Ring · De O-ring van de zeefdekking · Guarnizione O'ring · Silskydd O-ring · Sildeksel O-Ring · Sidæksel O-ring · Siivilä kannen O-rengas · Уплотнительное кольцо
3	Strainer basket · Panier de préfiltre · Cesto filtrante · Cesta do filtro · Filterkorb · Zeef mand · Cestino prefiltro · Silkorg · Sil kurv · Si kurv · Siivilä kori · Корзина пр
4	Pump Housing/Strainer · Corps de pompe et préfiltre · Cuerpo bomba y prefiltro · Corpo de bomba e préfiltre · Pumpengehäuse/Vorfilter · Lichaam van pomp en préfiltre · Corpo pompa/Prefiltro · Pumphus/sil · Pumpehus/sil · Pumpehus/si · Pumpun kotelo/siivilä · Копнус насоса
5	Drain Plug · Bouchon de vidange · Tapón de vaciado · Plugue de dreno · Ablassschraube · Afvoerkanal stop · Tappo di spurgo · Avtappingsplugg · Dreneringsplugg · Bundprop · Tyhjennustulppa · Сливная пробка
6	Housing insert & seal plate spacer kit · Inserts de corps · Parties de cuerpo · Inserts de corpos · KörperEinlagen · Inserts van lichamen · Inserzioni di corpo · Husinsats & tätningsplatta distanssats · Avstandssett for husinnsats og tetningsplate · Husindsats & tätningsplade afstandssæt · Kotelon sisäosa ja tiivistelevyn välikesarja · Втулка
7	Diffuser gasket · Joint de diffuseur · Junta de difusor · Junta de difusor · Dichtung · Verbindingsstuk van verspreider · Guarnizione diffusore · Diffusor pakning · Diffuserpakning · Diffuser pakning · Hajottimen tiiviste · Прокладка
8	Disffuser screws (x2) · Vis de diffuseur (x2) · Tornillo de difusor (x2) · Tornillos do difusor (x2) · Zerstäuberschraube (x2) · Schroef van verspreider (x2) · Vite di diffusore (x2) · Spridningssskruvar (x2) · Sprederskrue (x2) · Sprederskruer (x2) · Hajottimen ruuvit (x2) · Комплект винтов (x2)
9	Diffuser · Diffuseur · Difusor · Difusor · Leitapparat · Verspreide · Diffusore · Diffusor · Spreder · Diffuser · Hajotin · Диффузор
10	Impeller screw · Vis de turbine · Tornillo de turbina · Tornillos de turbina · Turbinenschraube · Schroef van turbine · Vite di turbina · Impellerskrue · Impeller skruer · Løbehjulsskrue · Juoksupyörän ruuvi · Комплект винтов
11	Ring for impeller · Bague pour turbine · Anillo para turbina · Ring de turbina · Ring für Laufrad · Ring voor Turbine · Anello · Ring för pumphjul · Ring for impeller · Ring til pumpehjul · Rengas juoksupyörälle · Уплотнительное кольцо
12	Impeller · Turbine · Turbina · Turbina · Laufrad · Turbine · Girante · Impeller · Impeller · Løbehjul · Juoksupyörä · Крыльчатка
13	Shaft Seal assembly · Obturateur mécanique · Cierre mecánico · Conjunto de selo · Motorhalterung · Verbindings assemblage · Tenuta meccanica · Axeltätningenshet · Akseltetningenshet · Akseltätningssamling · Akseltiivisteen kokooppa · Сальник в сборе
14	Housing gasket · Joint de corps · Junta · Gaxeta da carcaça · Dichtung · Huisvestings pakking · Guarnizione corpo · Huspakning · Huspakning · Huspakning · Kotelon tiiviste · Прокладка
15	Seal plate · Plateau d'étanchéité · Plato de cierre · Placa do selo · Flansch · Verbindings plaat · Supporto di fissaggio · Tätningsplatta · Forseglingssplate · Tätningssplate · Tiivistelevy · Фланец
16	Housing bolt · Vis corps de pompe · Tornillo cabeza exagonal · Tornillos de tampão da carcaça · Sechskantschraube · Huisvestings GLB schroeven · Viti a testa esagonale · Husbult · Husbolt · Husbolt · Kotelon pultti · Комплект болтов
17	Motor bolt · Vis moteur · Tornillo · Tornillos a motor · Sechskantschraube · Schroef motor · Viti · Motorbult · Motorbolt · Motor bolt · Moottorin pultti · Комплект болтов
18	Motor · Moteur · Motor · Motor · Motor · Motor · Motore · Motor · Motor · Motor · Moottori · Электродвигатель
19	Bracket motor support · Support de pompe · Soporte bomba · Suporte de montagem · Sockelteil · Opzettende steun · Supporto pompa · Fäste motorstöd · Brakett motorstøtte · Motorstøtte til beslag · Moottorin kannatintuki · Фланец электродвигателя
20	Gland · Presse étoupe · Prensa estopas · Imprensa estopa · Kabel-Klemme · Klier · Pressacavo · Körtel · Kjertel · Kirtel · Gland · Сальник
21a	Union connector kit 50 mm · Kit de raccord union 50 mm · Asamblea del conector de la unión 50 mm · Conjunto do conector da união 50 mm · Anschluß-Stecker 50 mm · de assemblage van de unieschakelaar 50 mm · Assembla del connettore del sindacato 50 mm · Kopplingsssats 50 mm · Union koblingssett 50 mm · Union stiksæt 50 mm · Liitinsarja 50 mm · Фитинг 50 мм
21b	Union connector kit 63 mm · Kit de raccord union 63 mm · Asamblea del conector de la unión 63 mm · Conjunto do conector da união 63 mm · Anschluß-Stecker 63 mm · de assemblage van de unieschakelaar 63 mm · Assembla del connettore del sindacato 63 mm · Kopplingsssats 63 mm · Union koblingssett 63 mm · Union stiksæt 63 mm · Liitinsarja 63 mm · Фитинг 63 мм
21c	Fitting pack 2" USA Imperial · Pack Raccord 2" USA Imperial · Paquete de unión 2" USA Imperial · 2" pacote de união USA Imperial · Passende Packung 2" USA Imperial · Montagepakket 2" USA Imperial · Pacchetto Union 2" USA Imperial · Fitting pack 2" USA Imperial · Fitting pack 2" USA Imperial · Fitting pack 2" USA Imperial · Asennuspaketti 2" USA Imperial · Комплект фитингов 2"
22	Union gasket · Joint pour raccord union · Junta tórica · Junta tórica de adaptador · O-Ring · O'ring Dichtheidsadepter · Guarnizione O'ring · Unionspakning · Union pakning · Union pakning · Unionin tiiviste · Прокладка
23	Electronic module VSTD · Module électronique VSTD · Módulo electrónico VSTD · Módulo electrónico VSTD · Elektronik-Modul VSTD · Elektronische module VSTD · Modulo elettronico VSTD · Elektronisk modul VSTD · Elektronisk modul VSTD · Elektronisk modul VSTD · Elektroninen moduuli VSTD · Электронный модуль
24	Electronic module VSTD · Module électronique VSTD · Módulo electrónico VSTD · Módulo electrónico VSTD · Elektronik-Modul VSTD · Elektronische module VSTD · Modulo elettronico VSTD · Elektronisk modul VSTD · Elektronisk modul VSTD · Elektronisk modul VSTD · Elektroninen moduuli VSTD · Электронный модуль

N°	Description / Description / Bezeichnung / Descripción / Descrizione / Beschrijving / Descrição / Описание
2+ 7+ 13+ 14	Set of gaskets · Pack de joints · Juego de juntas · Conjunto de juntas · Satz Dichtungen · Set van pakkingen · Set di guarnizioni · Uppsättning packningar · Sett med pakninger · Sæt med pakninger · Tiivistesarja · Комплект прокладок
-	Ventilateur · Fan · Ventilador · Fan · Fan · Ventilador · Fan · Ventilator · Ventilator · Ventilator · Tuuletin · вентилятор
-	Capot ventilateur · Fan cover · Cubierta del ventilador · Ventilatordeksel · Lüfterhaube · Fan cobertura · Copriventola · Capotventilator · Capot ventilator · Capot ventilator · Capot tuuletin · Кожух вентилятора
-	Motor Bearings Kit · Kit Roulements moteur · Kit de rodamientos de motor · Kit rolamentos do motor · Motorlager-Kit · Motorlagers kit · Kit cuscinetto del motore · Motorlagersats · Motorlagersett · Motor lejesæt · Moottorin laakerit · Подшипники двигателя комплект
	Slinger · Larmier · Arandela Separación · Arandela Separación · Tropfing · Tropfing · Rondella di separazione · Slinger · Slinger · Slinger · Slinger · Маслоъемное кольцо

Ordre de serrage des boulons - Bolt tightening order - Orden de apriete de los pernos - Ordem de aperto dos parafusos - Anzugsreihenfolge der Bolzen - Volgorde waarin de bouten vastgedraaid moeten worden - Ordine di stringimento bulloni - Ordning för att dra åt bultarna - Spændingsrækkefølge for bolte - Rækkefølge for tiltrekking av boltene - Pulltien kiristysjärjestys - Порядок затяжки болтов

185 INCH LBS

20.9 N m

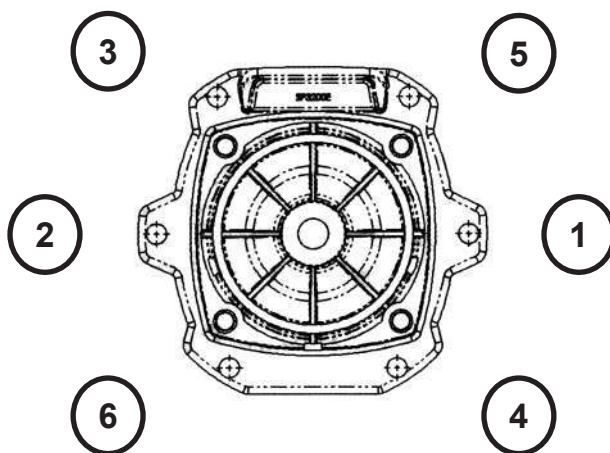

K-FLO VSTD SERIES
SPK12615VSTD

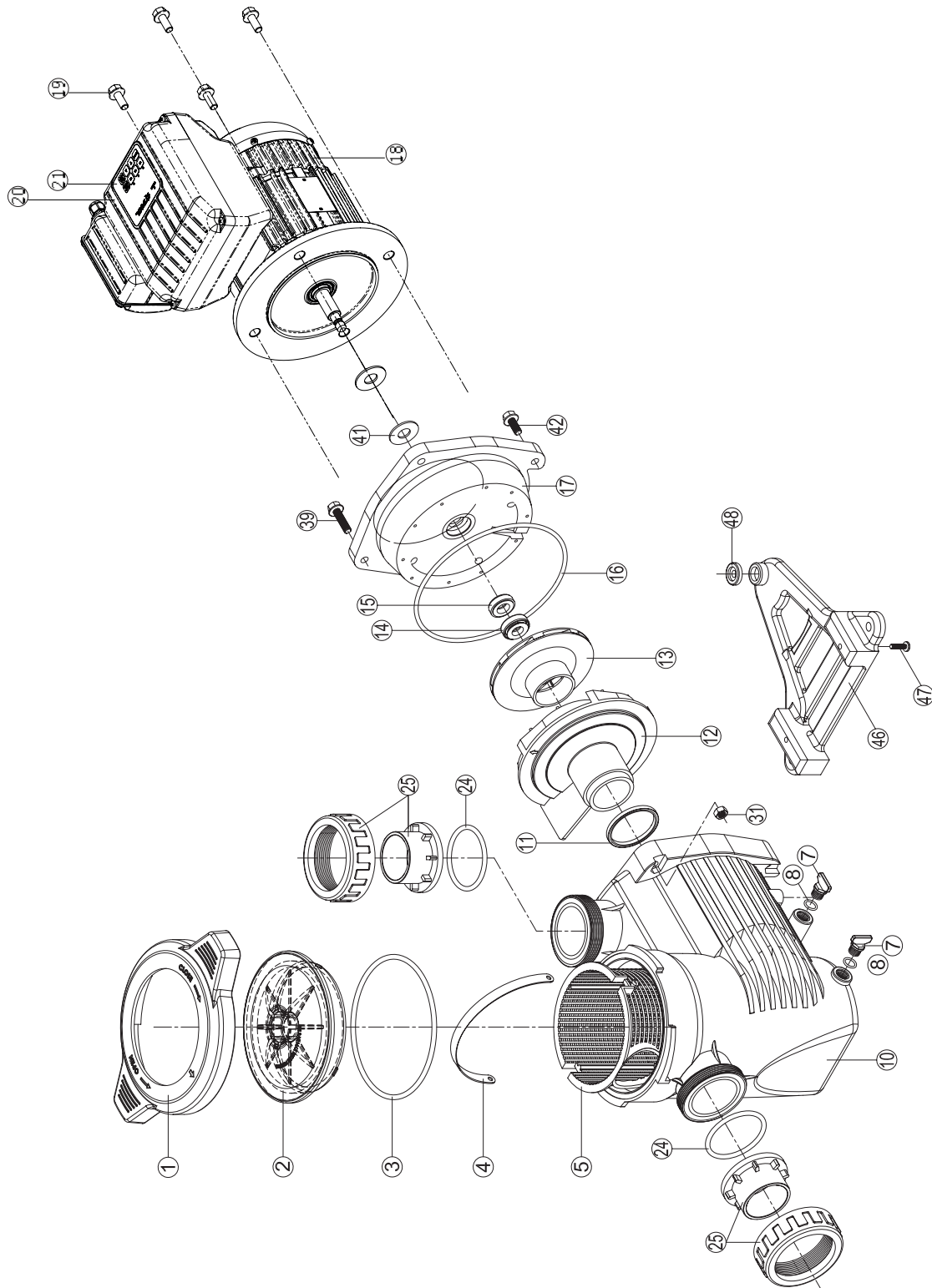

N°	Description · Description · Descripción · Descrição · Bezeichnung · Beschrijving · Descrizione · Beskrivning · Beskrivelse · Beskrivelse · Kuvaus · Описание
1	Locking nut · Écrou couvercle préfiltre · Tuerca de cierre · Porca da tampa do pré-filtro · Mutter Vorfilterdeckel · Moer deksel voorfilter · Dado coperchio prefiltro · Låsmutter · Låsemutter · Låsemøtrik · Lukitusmutteri · Гайка крышки грубой фильтрации
2	Cover kit (cover + o-ring) · Kit couvercle (couvercle + joint torique) · Conjunto tapa + junta · Kit da tampa (tampa + junta tórica) · Deckelset (Deckel + O-Ring) · Dekselset (deksel + O-ring) · Kit coperchio (coperchio + guarnizione torica) · Skyddssats (hölje + o-ring) · Dekselsett (deksel + o-ring) · Dæksæt (cover + o-ring) · Kansisarja (kansi + O-rengas) · Комплект крышки (крышка + кольцевое уплотнение)
3	Cover o-ring · Joint torique couvercle · Junta de tapa · Junta tórica da tampa · O-Ring Deckel · O-ring van deksel · Guarnizione torica coperchio · Täck o-ring · Dekk o-ring · Dæk o-ring · Kannen O-rengas · Кольцевое уплотнение крышки
4+5	Strainer basket · Panier de préfiltre · Cestillo prefiltro · Cesto do pré-filtro · Vorfilterkorb · Mand van voorfilter · Cesto prefiltro · Silkorg · Sil kurv · Si kurv · Siivilä kori · Малая корзина грубой фильтрации
7+8	Drain kit · Kit vidange · Kit tapon desague · Kit de vazamento · Entleerungsset · Aftapset · Kit di spurgo · Avloppssats · Avløpssett · Afløbs-sæt · Viemärisarja · Набор опорожнения
3+8+ 11+ 16+ 24	Pump gasket kit · Jeu complet de joints pompe · Juego completo juntas · Jogo completo de juntas da bomba · Kompletter Satz Pumpendichtungen · Compleet set van pompringen · Set completo di guarnizioni pompa · Pumpackningssats · Pumpepakningssett · Pumpepakningssæt · Pumpun tiivistesarja · Полный набор уплотнений для насоса
10	Pump casing · Corps de pompe · Cuerpo de bomba · Corpo da bomba · Pumpengehäuse · Pomphuis · Corpo della pompa · Pumphus · Pumpehus · Pumpehus · Pumpun kotelo · Корпус насоса
11	Diffuser o-ring · Joint torique de diffuseur · Junta difusor · Junta tórica do difusor · O-Ring Diffusor · O-ring van diffusor · Guarnizione torica diffusore · Diffusor o-ring · Diffusor o-ring · Diffusor o-ring · Hajottimen O-rengas · Кольцевое уплотнение диффузора
12	Diffuser · Diffuseur · Difusor · Difusor · Diffusor · Diffusor · Diffusore · Diffusor · Spreder · Diffuser · Hajotin · Диффузор
13	Impeller VS 1,5HP · Turbine VS 1,5 CV · Rodete VS 1,5 CV · Turbina VS 1,5 CV · Turbine VS 1,5 PS · Rotor VS 1,5 PK · Turbina VS 1,5 CV · Impeller VS 1,5HP · Impeller VS 1,5HK · Løbehjul VS 1,5HK · Juoksupyörä VS 1,5hv · Турбина VS 1,5 л.с.
14+ 15	Mechanical seal kit · Garniture mécanique · Conjunto retén · Vedação mecânica · Mechanische Dichtung · Mechanische dichtingen · Tenuta meccanica · Mekanisk tätningssats · Mekanisk tetningssett · Mekanisk tætningsæt · Mekaaninen tiivistesarja · Механическое уплотнение
16	Casing flange o-ring · Joint plateau d'étanchéité · Junta cuerpo union · Junta do disco de vedação · Dichtung Dichtplatte · O-ring afdichtingsflens · Guarnizione flangia · Husfläns o-ring · Husflens o-ring · Husflange o-ring · Kotelon laipan O-rengas · Прокладка уплотнительной пластины
17	Casing flange · Plateau d'étanchéité · Cuerpo union · Disco de vedação · Dichtplatte · Afdichtingsflens · Flangia di tenuta · Husfläns · Husflens · Husflange · Kotelon laippa · Уплотнительная пластина
18	Motor 1.5HP VS · Moteur 1,5 CV VS · Motor 1.5 CV VS · Motor 1,5 CV VS · Motor 1,5 PS VS · Motor 1,5 PK VS · Motore 1,5 CV VS · Motor 1,5 hk VS · Motor 1,5HK VS · Motor 1,5HK VS · Moottori 1,5hv VS · Двигатель 1,5 л.с. VS
19	Gland · Presse-étoupe · Prensa estopas · Bucim de empanque · Stopfbüchse · Pakkingbus · Pressacavo · Körteel · Kjørtel · Kirtel · Gland · Уплотненный кабельный ввод
20	Electronic module · Module électronique · Modulo elettronico · Módulo eletrônico · Elektronikmodul · Elektronische module · Modulo elettronico · Elektronisk modul · Elektronisk modul · Elektronisk modul · Elektroninen moduuli · Электронный модуль
21	User interface VSTD · Interface utilisateur VSTD · Interfaz de usuario VSTD · Пользовательский интерфейс VSTD · Benutzerschnittstelle VSTD · Interface do utilizador VSTD · Interfaccia utente VSTD · Gebruikersinterface VSTD · Användargränssnitt VSTD · Brukergrensesnitt VSTD · Brugergrenseflade VSTD · Käyttöliittymä VSTD ·
24+ 25	Set of unions · Kit raccord union · Kit enlaces · Kit de unioes de ligacao · Verschraubungssatz · Set koppelstukken · Kit raccordi di collegamento · Uppsättning av fackföreningar · Sett med fagforeninger · Sæt af fagforeninger · Joukko ammattiliittoja · Набор соединения union
31+39 +42 +47	Hardware kit · Kit visserie · Kit tornilleria completa · Kit de peças de fixação · Schraubensatz · Schroeven en moeren · Kit bulloneria · Hårdvarusats · Maskinvareset · Hardware sæt · Laitteistosarja · Комплект резьбовых деталей
41	Slinger · Pare-goutte · Paragotero · Anel defletor · Tropfschutz · Morsring · Anello paracqua · Slinger · Slinger · Slinger · Slinger · Капельное кольцо
46+48	Pump support · Support de pompe · Base de bomba · Suporte da bomba · Pumpenträger · Pompbasis · Supporto della pompa · Pumpstöd · Pumpestøtte · Pumpestøtte · Pumpun tuki · Опора насоса
-	Fan HG 0.50-1.50HP M · Ventilateur HG 0,50-1,50 CV M · Ventilador HG 0.50-1.50 CV M · Ventoinha HG 0,50-1.50 CV M · Lüfter HG 0,50-1,50 PS M · Ventilator HG 0,50-1,50 PK M · Ventilatore HG 0,50-1,50 CV M · Fläkt HG 0,50-1,50HP M · Vifte HG 0,50-1,50 HK M · Ventilator HG 0,50-1,50HK M · Tuuletin HG 0,50-1,50HP M · Вентилятор HG 0,50-1,50 л.с. M
-	Fan cover VS · Capot ventilateur VS · Tapa ventilador VS · Tampa da ventoinha VS · Lüfterabdeckung VS · Ventilatorkap VS · Coperchio ventilatore VS · Fläktkåpa VS · Viftedeksel VS · Ventilator dæksel VS · Tuulettimen kansi VS · Крышка вентилятора VS
-	Bearings kit Motor RF 1 · Kit roulements moteur RF 1 · Kit rodamientos Motor RF 1 · Kit de rolamentos do motor RF 1 · Lageret Motor RF 1 · Set lagers voor motor RF 1 · Kit cuscinetti motore RF 1 · Lagersats Motor RF 1 · Lagersett Motor RF 1 · Lejesæt Motor RF 1 · Laakerisarja Moottori RF 1 · Набор подшипников двигателя RF 1

RS II VSTD SERIES

RS3016VSTD

RS3020VSTD

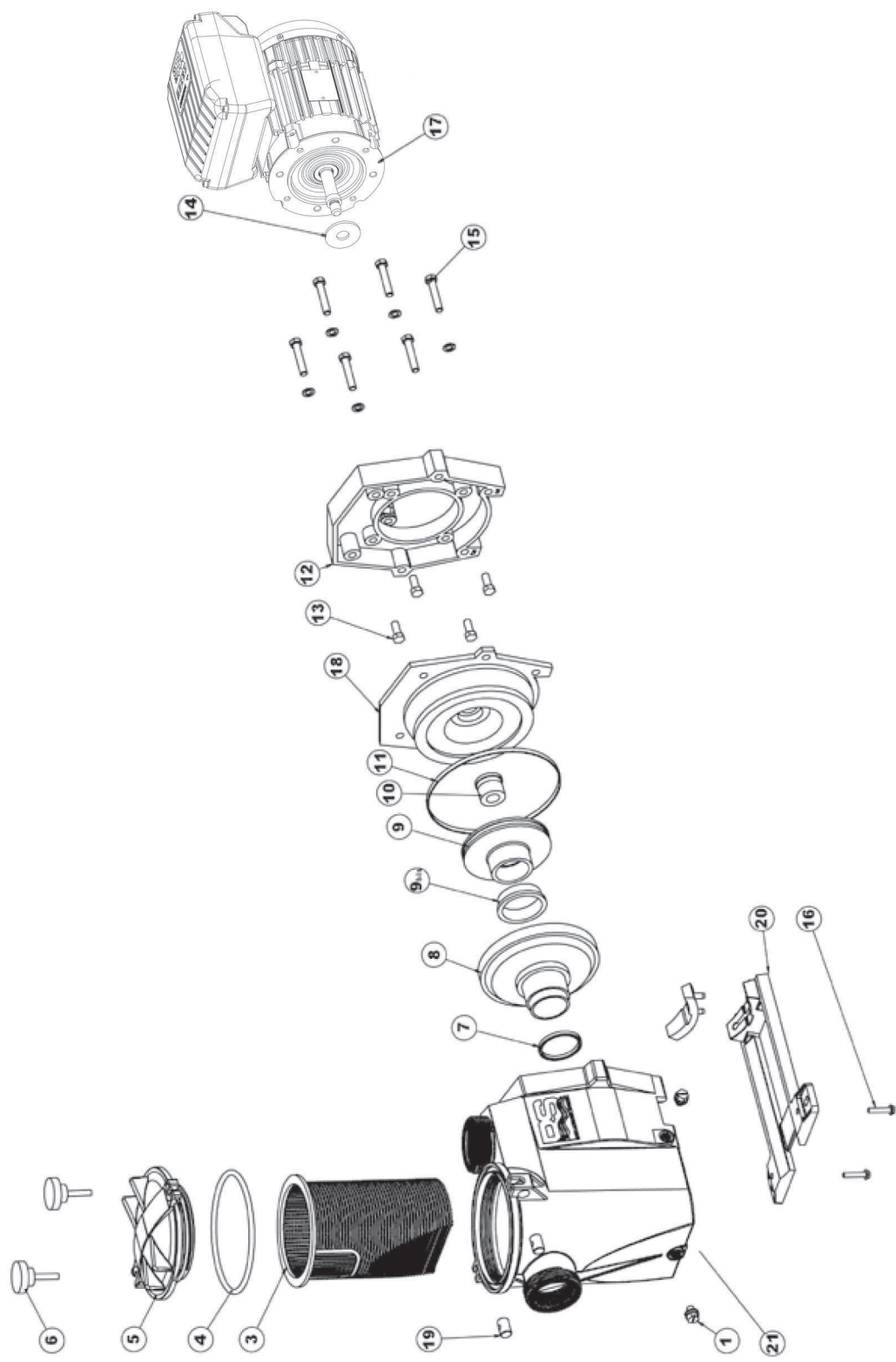

N°	Description · Description · Descripción · Descrição · Bezeichnung · Beschrijving · Descrizione · Beskrivning · Beskrivelse · Beskrivelse · Kuvaus · Описание
1	Drain Plug · Bouchon de vidange · Tapón de vaciado · Plugue de dreno · Ablassschraube · Afvoerkanal stop · Tappo di spurgo · Avtappingsplugg · Dreneringsplugg · Bundprop · Tyhjennystulppa · Комплект сливных пробок
3	Strainer basket · Panier de préfiltre · Cesto filtrante · Cesta do filtro · Filterkorb · Zeef mand · Cestino prefiltro · Silkorg · Sil kurv · Si kurv · Siivilä kori · Корзина префильтра
4	Strainer cover O-Ring · Joint torique · Junta tórica · Уплотнительное кольцо · O-Ring · De O-ring van de zeefdekking · O-Ring de tampa do filtro · Guarnizione O'ring · Silskydd O-ring · Sildeksel O-Ring · Sidæksel O-ring · Siivilä kannen O-rengas ·
5	Strainer cover · Couvercle de préfiltre · Tapa de prefiltro · Tampa do filtro · Deckel · Zeef dekking · Coperchio prefiltro · Silskydd · Sildeksel · Si dæksel · Siivilä kansi · Крышка префильтра
7	Diffuser gasket · Joint de diffuseur · Junta de difusor · Junta de difusor · Dichtung · Verbindingsstuk van verspreider · Guarnizione diffusore · Diffusor packning · Diffuserpakning · Diffuser pakning · Hajotimen tiiviste · Прокладка
8	Diffuser · Diffuseur · Difusor · Difusor · Leitapparat · Verspreide · Diffusore · Diffusor · Spreder · Diffuser · Hajotin · Диффузор
9	Impeller · Turbine · Turbina · Turbina · Laufrad · Turbine · Girante · Impeller · Impeller · Løbehjul · Juoksupyörä · Крыльчатка
9 bis	Ring for impeller · Bague pour turbine · Anillo para turbina · Anel para turbina · Ring für Laufrad · Ring voor Turbine · Anello · Ring för pumphjul · Ring for impeller · Ring til pumpehjul · Rengas juoksupyörälle · Уплотнительное кольцо
10	Seal assembly · Obturateur mécanique · Cierre mecánico · Conjunto de selo · Motorhalterung · Verbindings assemblage · Tenuta meccanica · Tättningsmontering · Tøttningsmontering · Tætningssamling · Tiivisteen kokoonpano · Сальник в сборе
11	Housing gasket · Joint de corps · Junta · Gaxeta da carcaça · Dichtung · Huisvestings pakking · Guarnizione corpo · Huspackning · Huspakning · Kotelon tiiviste · Прокладка
12	Motor mounting plate · Support moteur · Soporte motor · Apoio a motor · Motorhalterung · Motorsteun · Supporto motore · Motor monteringsplatta · Motor monteringsplate · Motor monteringsplade · Moottorin asennuslevy · Фланец электродвигателя
13	Motor cap screw · Vis moteur · Tornillo · Tornillos a motor · Sechskrantschraube · Schroef motor · Viti · Motorskruv · Motorskrue · Motor hætteskruer · Moottorin kannen ruuvi · Комплект винтов
14	Slinger · Larmier · Arandela Separación · Arandela Separación · Tropfing · Tropfing · Rondella di separazione · Slinger · Slinger · Slinger · Slinger · Маслосъемное кольцо
15	Housing cap screws · Vis corps de pompe · Tornillo cabeza exagonal · Tornillos de tampão da carcaça · Sechskantschraube · Huisvestings GLB schroeven · Viti a testa esagonale · Kârans skruvar · Husets hodeskruer · Husets hætteskruer · Kotelon kannen ruuvit · Комплект винтов
16	Cap screw · Vis support de pompe · Tornillo cabeza exagonal · Tornillos apoio de bomba · Sechskantschraube · Schroef steun van pomp · Viti · Kapselskruv · Toppskrue · Skruelåg · Kantaruuvi · Комплект винтов
17	Motor · Moteur · Motor · Motor · Motor · Motor · Motore · Motor · Motor · Motor · Moottori · Электродвигатель
18	Seal plate · Plateau d'étanchéité · Plato de cierre · Placa do selo · Flansch · Verbindings plaa · Supporto di fissaggio · Tättningsplatta · Forseglingsplate · Tættningsplade · Tiivistelevy · Фланец
19+6	Swivel nut + Hand knob · Erou rotule + Vis papillon · Rótula + Tornillo maripó · Tuerca de giro+ Parafuso borboleta · Gewindezapfen + Flügelschraube · Wartel noot + Schroef vliinder · Perno Manopola di chiusura · Svängmutter + Handknopp · Svingmutter + håndknapp · Drejemøtrik + Håndknop · Käätömutteri + käsinuppi · Комплект втулок и винтов
20	Mounting bracket · Support de pompe · Soporte bomba · Suporte de montagem · Socketteil · Opzettende steun · Supporto pompa · Monteringsfäste · Monteringsbrakett · Monteringsbeslag · Kiinnike · Монтажная стойка
21	Assembly Body RS II (body, basket, cover, feets) · Corps assemblé RS II (Corps, panier, couvercle, pieds) · Cuerpo montado RS II (cuerpo, cesta, tapa, pie) · Corpo armado RSII (corpo, cesto, tampa, pé) · Zusammengesetzler Körper RS II (körper, korb, deckel, fub) · Assemblage lichaam RS II (Lichaam, Zeef mand, Zeef dekking, Voeten) · Corpo riunito RS II (corpo, canestro, coperchio, piede) · Monteringskropp RS II (kropp, korg, lock, fötter) · Monteringskropp RS II (kropp, kurv, deksel, fötter) · Samlingskrop RS II (krop, kurv, dæksel, fødder) · Asennusrunko RS II (runko, kori, kansi, jalat) · Корпус насоса в
4+7+10+11 14	Set of gaskets · Pack de joints · Juego de juntas · Conjunto de juntas · Satz Dichtungen · Set van pakkingen · Set di guarnizioni · Uppsättning packningar · Sett med pakninger · Sæt med pakninger · Tiivistesarja · Комплект прокладок

MAX FLO XL VSTD SERIES

SP2310VSTD

SP2315VSTD

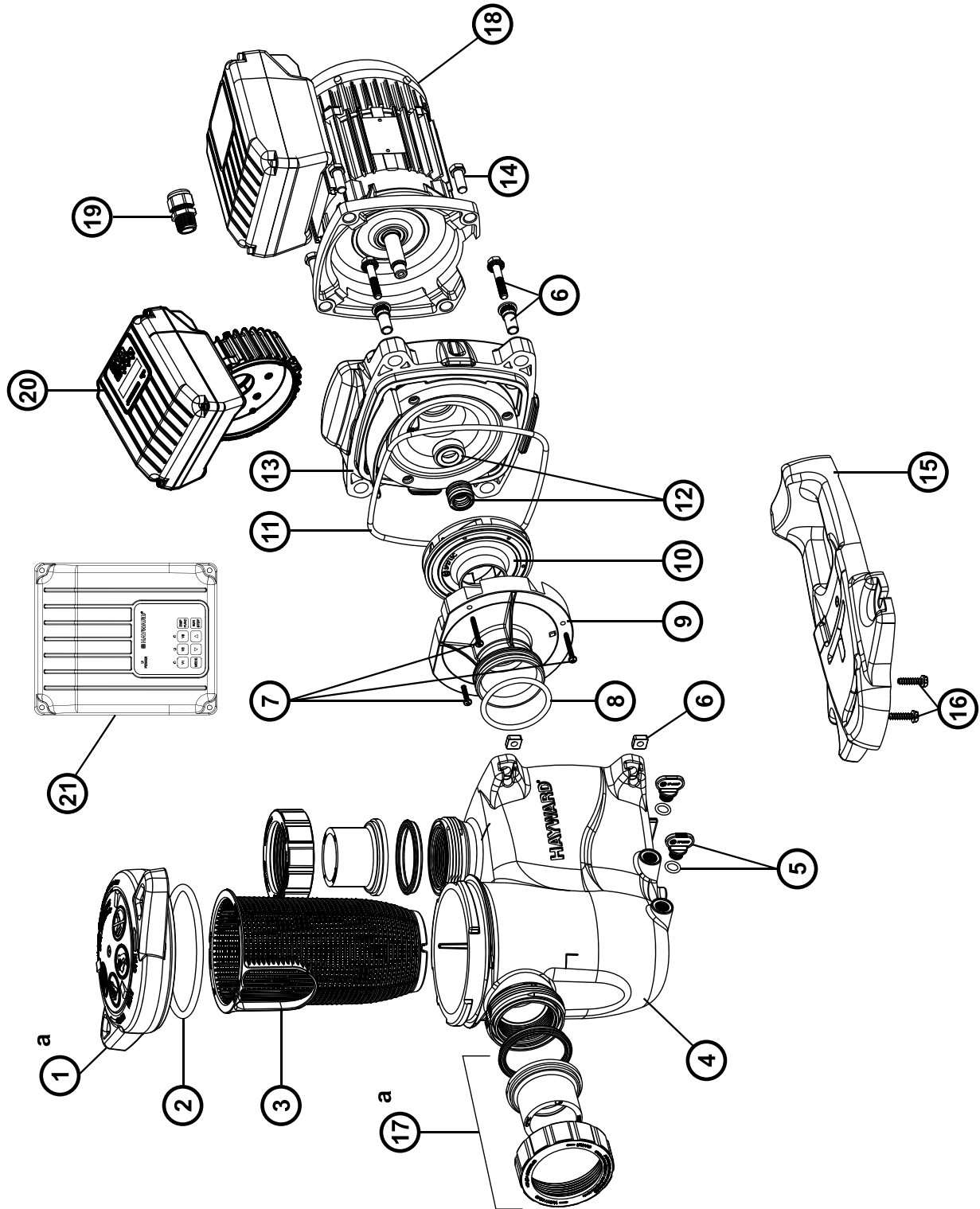

Nº	Description · Description · Descripción · Descrição · Bezeichnung · Beschrijving · Descrizione · Beskrivning · Beskrivelse · Beskrivelse · Kuvaus · Описание
1	Locking nut · Écrou couvercle préfiltre · Tuerca de cierre · Porca da tampa do pré-filtro · Mutter Vorfilterdeckel · Moer deksel voorfilter · Dado coperchio prefiltro · Låsmutter · Låsemutter · Låsemøtrik · Lukitusmutteri · Гайка крышки грубой фильтрации
2+3	Cover kit (cover + o-ring) · Kit couvercle (couvercle + joint torique) · Conjunto tapa + junta · Kit da tampa (tampa + junta tórica) · Deckelset (Deckel + O-Ring) · Dekselset (deksel + O-ring) · Kit coperchio (coperchio + guarnizione torica) · Skyddssats (hölje + o-ring) · Dekselsett (deksel + o-ring) · Dæksæt (cover + o-ring) · Kansisarja (kansi + O-rengas) · Комплект крышки (крышка + кольцевое уплотнение)
3	Cover o-ring · Joint torique couvercle · Junta de tapa · Junta tórica da tampa · O-Ring Deckel · O-ring van deksel · Guarnizione torica coperchio · Täck o-ring · Dekk o-ring · Dæk o-ring · Kannen O-rengas · Кольцевое уплотнение крышки
4+5	Strainer basket · Panier de préfiltre · Cestillo prefiltro · Cesto do pré-filtro · Vorfilterkorb · Mand van voorfilter · Cesto prefiltro · Silkorg · Sil kurv · Si kurv · Siivilä kori · Малая корзина грубой фильтрации
7+8	Drain kit · Kit vidange · Kit tapon desague · Kit de vazamento · Entleerungsset · Aftapset · Kit di spurgo · 7+8 Avloppssats · 7+8 Avløpssett · 7+8 Afløbssæt · 7+8 Viemärisarja · Набор опорожнения
3+8+ 11+16 24	Pump gasket kit · Jeu complet de joints pompe · Juego completo juntas · Jogo completo de juntas da bomba · Kompletter Satz Pumpendichtungen · Compleet set van pompringen · Set completo di guarnizioni pompa · Pumpackningssats · Pumpepakningssett · Pumpepakningssæt · Pumpun tiivistesarja · Полный набор уплотнений для насоса
10	Pump casing · Corps de pompe · Cuerpo de bomba · Corpo da bomba · Pumpengehäuse · Pomphuis · Corpo della pompa · Pumphus · Pumpehus · Pumpehus · Pumpun kotelo · Корпус насоса
11	Diffuser o-ring · Joint torique de diffuseur · Junta difusor · Junta tórica do difusor · O-Ring Diffusor · O-ring van diffusor · Guarnizione torica diffusore · Diffusor o-ring · Diffusor o-ring · Diffusor o-ring · Hajottimen O-rengas · Кольцевое уплотнение диффузора
12	Diffuser · Diffuseur · Difusor · Difusor · Diffusor · Diffusor · Diffusore · Diffusor · Spreder · Diffuser · Hajotin · Диффузор
13	Impeller VS 1,5HP · Turbine VS 1,5 CV · Rodete VS 1,5 CV · Turbina VS 1,5 CV · Turbine VS 1,5 PS · Rotor VS 1,5 PK · Turbina VS 1,5 CV · Impeller VS 1,5HP · Impeller VS 1,5HK · Løbehjul VS 1,5HK · Juoksupyörä VS 1,5hv · Турбина VS 1,5 л.с.
14+15	Mechanical seal kit · Garniture mécanique · Conjunto retén · Vedação mecânica · Mechanische Dichtung · Mechanische dichtingen · Tenuta meccanica · Mekanisk tätningssats · Mekanisk tetningssett · Mekanisk tætningsæt · Mekaaninen tiivistesarja · Механическое уплотнение
16	Casing flange o-ring · Joint plateau d'étanchéité · Junta cuerpo union · Junta do disco de vedação · Dichtung Dichtplatte · O-ring afdichtingsflens · Guarnizione flangia · Husfläns o-ring · Husflens o-ring · Husflange o-ring · Kotelon laipan O-rengas · Прокладка уплотнительной пластины
17	Casing flange · Plateau d'étanchéité · Cuerpo union · Disco de vedação · Dichtplatte · Afdichtingsflens · Flangia di tenuta · Husfläns · Husflens · Husflange · Kotelon laippa · Уплотнительная пластина
18+48	Pump support · Support de pompe · Base de bomba · Suporte da bomba · Pumpenträger · Pompbasis · Supporto della pompa · Pumpstöd · Pumpestøtte · Pumpestøtte · Pumpun tuki · Опора насоса
18	Motor 1.5HP VS · Moteur 1,5 CV VS · Motor 1.5 CV VS · Motor 1,5 CV VS · Motor 1,5 PS VS · Motor 1,5 PK VS · Motore 1,5 CV VS · Motor 1,5 hk VS · Motor 1,5HK VS · Motor 1,5HK VS · Moottori 1,5hv VS · Двигатель 1,5 л.с. VS
19	Gland · Presse-étoupe · Prensa estopas · Bucim de empanque · Stopfbüchse · Pakkingbus · Pressacavo · Körtel · Kjertel · Kirtel · Gland · Уплотненный кабельный ввод
20	Electronic module · Module électronique · Modulo elettronico · Módulo eletrônico · Elektronikmodul · Elektronische module · Modulo elettronico · Elektronisk modul · Elektronisk modul · Elektronisk modul · Elektroninen moduuli · Электронный модуль
21	User interface VSTD · Interface utilisateur VSTD · Interfaz de usuario VSTD · Interface do utilizador VSTD · Benutzerschnittstelle VSTD · Gebruikersinterface VSTD · Interfaccia utente VSTD · Användargränssnitt VSTD · Brukergrensesnitt VSTD · Brugergrænseflade VSTD · Käyttöliittymä VSTD · Пользовательский интерфейс VSTD
24+25	Set of unions · Kit raccord union · Kit enlacs · Kit de unioes de ligacao · Verschraubungssatz · Set koppelstukken · Kit raccordi di collegamento · Uppsättning av fackföreningar · Sett med fagforeninger · Sæt af fagforeninger · Joukko ammattiliittoa · Набор соединения union
31+39 +42 +47	Hardware kit · Kit visserie · Kit tornilleria completa · Kit de peças de fixação · Schraubensatz · Schroeven en moeren · Kit bulloneria · Hårdvarusats · Maskinvareset · Hardware sæt · Laitteistosarja · Комплект резьбовых деталей
41	Slinger · Pare-goutte · Paragotero · Anel defletor · Tropfschutz · Morsring · Anello paracqua · Slinger · Slinger · Slinger · Slinger · Капельное кольцо
-	Fan HG 0.50-1.50HP M · Ventilateur HG 0,50-1,50 CV M · Ventilador HG 0.50-1.50 CV M · Ventoinha HG 0,50-1.50 CV M · Lüfter HG 0,50-1,50 PS M · Ventilator HG 0,50-1,50 PK M · Ventilatore HG 0,50-1,50 CV M · Fläkt HG 0,50-1,50HP M · Vifte HG 0,50-1,50 HK M · Ventilator HG 0,50-1,50HK M · Tuuletin HG 0,50-1,50HP M · Вентилятор HG 0,50-1,50 л.с. M
-	Fan cover VS · Capot ventilateur VS · Tapa ventilador VS · Tampa da ventoinha VS · Lüfterabdeckung VS · Ventilatorkap VS · Coperchio ventilatore VS · Fläktkåpa VS · Viftedeksel VS · Ventilatordæksel VS · Tuulettimen kansi VS · Крышка вентилятора VS
-	Bearings kit Motor RF 1 · Kit roulements moteur RF 1 · Kit rodamientos Motor RF 1 · Kit de rolamentos do motor RF 1 · Lagerset Motor RF 1 · Set lagers voor motor RF 1 · Kit cuscinetti motore RF 1 · Lagersats Motor RF 1 · Lagersett Motor RF 1 · Lejesæt Motor RF 1 · Laakerisarja Moottori RF 1 · Набор подшипников двигателя RF 1

Ordre de serrage des boulons - Bolt tightening order - Orden de apriete de los pernos - Ordem de aperto dos parafusos
- Anzugsreihenfolge der Bolzen - Volgorde waarin de bouten vastgedraaid moeten worden - Ordine di stringimento bulloni -
Ordning för att dra åt bultarna - Spændingsrækkefølge for bolte - Rekkefølge for tiltrekking av boltene - Pulttien kiristysjärjestys
- Порядок затяжки болтов

185 INCH LBS

20.9 N m

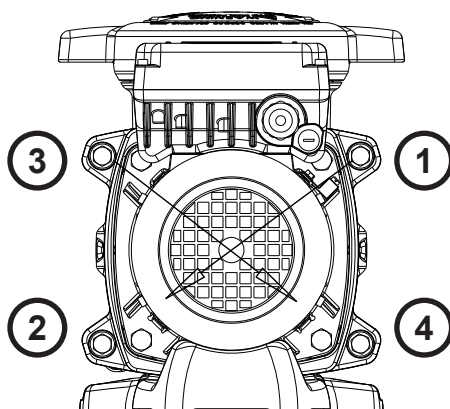

SUPERPUMP VSTD
SP2611VSTD
SP2616VSTD

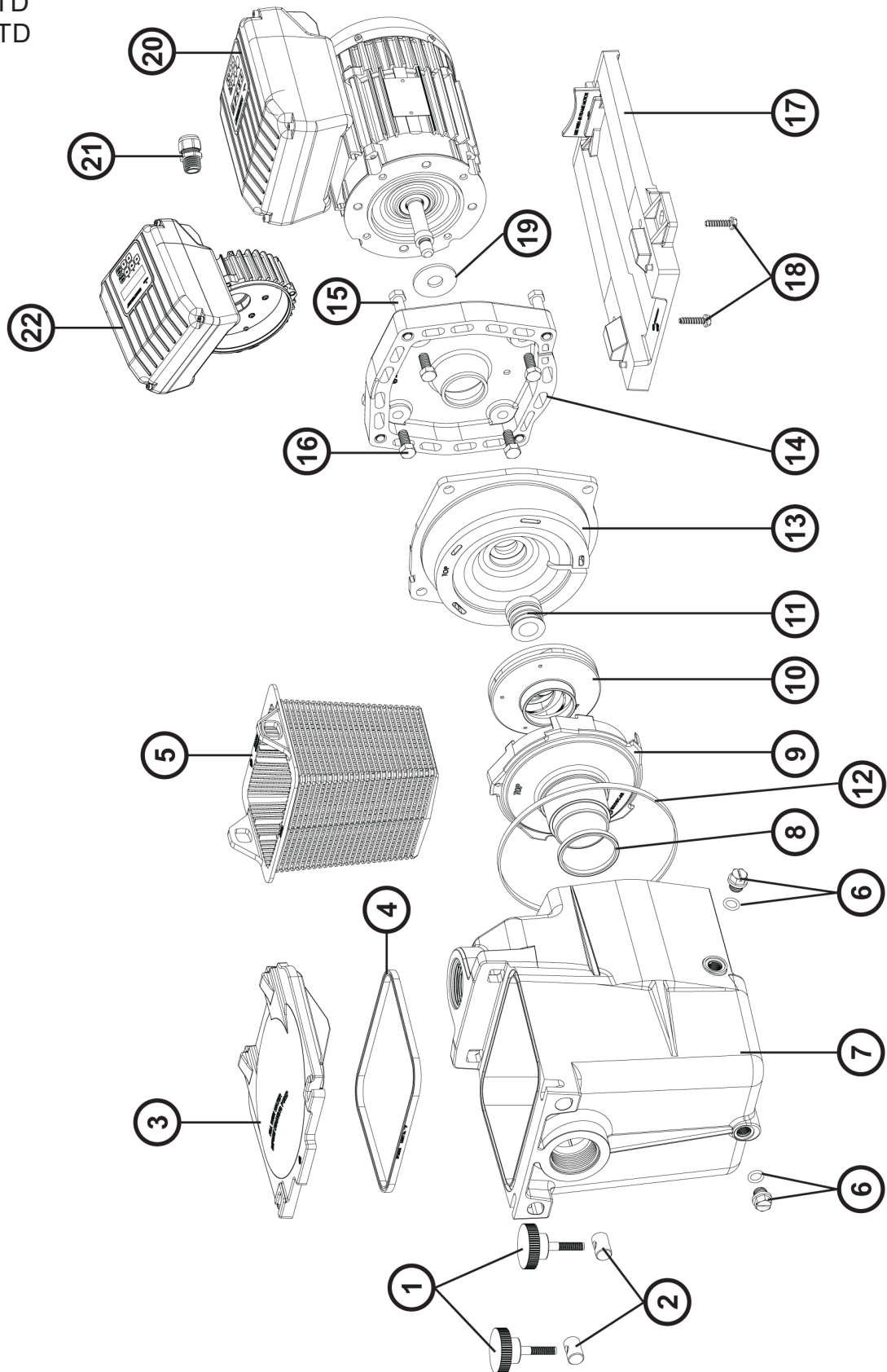

N°	Description · Description · Descripción · Descrição · Bezeichnung · Beschrijving · Descrizione · Beskrivning · Beskrivelse · Beskrivelse · Киваус · Описание
1+2	Swivel nut + Hand knob · Ecrou rotule + Vis papillon · Rótula + Tornillo mariposa · Tuerca de giro+ Parafuso borboleta · Gewindezapfen + Flügelschraube · Wartel noot + Schroef vlinder · Perno girevole + Manopola di chiusura · Svängmutter + Handknopp · Svingmutter + håndknapp · Drejemøtrik + Håndknop · Käöntömutteri + käsinuppi · Комплект втулок и винтов
3	Strainer cover · Couvercle de préfiltre · Tapa de prefiltro · Tampa do filtro · Deckel · Zeef dekking · Coperchio prefiltro · Silskydd · Sildeksel · Si dæksel · Siivilä kansi · Крышка префильтра
4	Lid gasket · Joint de préfiltre · Junta de prefiltro · Junta préfiltre · Dichtung · Verbindingsstuk van préfiltre · Guarnizione prefiltro · Lockets packning · Lokkpakning · Lågpakning · Kannen tiiviste · Прокладка
5	Strainer basket · Panier de préfiltre · Cesto filtrante · Cesta do filtro · Filterkorb · Zeef mand · Cestino prefiltro · Silkorg · Sil kurv · Si kurv · Siivilä kori · Корзина префильтра
6	Drain Plug · Bouchon de vidange · Tapón de vaciado · Plugue de dreno · Ablassschraube · Afvoerkanal stop · Tappo di spurgo · Avtappingsplugg · Dreneringsplugg · Bundprop · Tyhjennystulppa · Комплект сливных пробок
7	Pump Housing/Strainer · Corps de pompe et préfiltre · Cuerpo bomba y prefiltro · Corpo de bomba e préfiltre · Pumpengehäuse/Vorfilter · Lichaam van pomp en préfiltre · Corpo pompa/ Prefiltro · Pumphus/sil · Pumpehus/sil · Pumpehus/si · Pumpun kotelo/siivilä · Копныц насоса
8	Diffuser gasket · Joint de diffuseur · Junta de difusor · Junta de difusor · Dichtung · Verbindingsstuk van verspreider · Guarnizione diffusore · Diffusor packning · Diffuserpakning · Diffuser pakning · Hajottimen tiiviste · рокладка
9	Diffuser · Diffuseur · Difusor · Difusor · Leitapparat · Verspreide · Diffusore · Diffusor · Spreder · Diffuser · Hajotin · Диффузор
10	Impeller · Turbine · Turbina · Turbina · Laufrad · Turbine · Girante · Impeller · Impeller · Løbehjul · Juoksupyörä · Крыльчатка
11	Seal assembly · Obturateur mécanique · Cierre mecánico · Conjunto de selo · Motorhalterung · Verbindings assemblage · Tenuta meccanica · Tätningsmontering · Tetningsmontering · Tætningssamling · Tiivisteen kokoonpano · Сальник в сборе
12	Housing gasket · Joint de corps · Junta · Gaxeta da carcaça · Dichtung · Huisvestings pakking · Guarnizione corpo · Huspackning · Huspakning · Kotelon tiiviste · Прокладка
13+14	Seal plate+Motor mounting plate · Plateau d'étancheité+Support moteur · Plato de cierre+Soporte motor · Placa do selo+Apoio a motor · Flansch+Motorhalterung · Verbindings plaat+Motorsteun · Supporto di fissaggio+Supporto motore · Tätningsplatta+Motormonteringsplatta · Tetningsplate+Motormonteringsplate · Tætningssplate+Motor monteringsplade · Tiivistelevy + moottorin asennuslevy · Фланец+Фланец электродвигателя
15	Housing screw · Vis plateau d'étanchéité · Tornillo de cabeza hexagonal · Tornillos de carcaça · Sechskantschraube · Huisvestings schroeven · Viti esagonali · Husskrøv · Husskrue · Husskrue · Kotelon ruuvi · Набор винтов
16	Motor cap screw · Vis moteur · Tornillo · Tornillos a motor · Sechskantschraube · Schroef motor · Viti · Motorskrøv · Motorskrue · Motor hætteskrue · Moottorin kannen ruuvi · Набор винтов
17	Mounting bracket · Support de pompe · Soporte bomba · Suporte de montagem · Socketteil · Opzettende steun · Supporto pompa · Monteringsfäste · Monteringsbrakett · Monteringsbeslag · Kiinnike · Монтажная стойка
18	Cap screw · Vis support de pompe · Tornillo cabeza exagonal · Parafuso apoio de bomba · Sechskantschraube · Schroef steun van pomp · Viti · Kapselskrøv · Toppskrue · Skruelåg · Kantaruuvi · Набор винтов
19	Slinger · Larmier · Arandela Separación · Arandela Separación · Tropfing · Tropfing · Rondella di separazione · Slinger · Slinger · Slinger · Slinger · Маслосъемное кольцо
20	Motor · Moteur · Motor · Motor · Motor · Motor · Motore · Motor · Motor · Motor · Moottori · Электродвигатель
21	Gland · Presse étoupe · Prensa estopas · Imprensa estopa · Kabel-Klemme · Klier · Pressacavo · Körtel · Kjertel · Kirtel · Gland · Сальник 1 SPX1100PE 71,19
22	Electronic module · Module électronique · Módulo electrónico · Módulo electrónico · Elektronik-Modul · Elektronische module · Modulo elettronico · Elektronisk modul · Elektronisk modul · Elektronisk modul · Elektroninen moduuli · Электронный модуль
23	User interface · Interface utilisateur · interfaz de usuario · Interface do usuário · Benutzerschnittstelle · gebruikersinterface · interfaccia utente · Användargränssnitt · Brukergrensesnitt · brugergrænseflade · Käyttöliittymä · интерфейс пользователя
4+8+11+12+19	Set of gaskets · Pack de joints · Juego de juntas · Conjunto de juntas · Satz Dichtungen · Set van pakkingen · Set di guarnizioni · Upsättning packningar · Sett med pakninger · Sæt med pakninger · Tiivistesarja · Комплект прокладок
-	Fan · Ventilateur · Ventilador · Fan · Fan · Ventilador · Fan · Fläkt · Fan · Ventilator · Tuuletin · вентилятор
-	Fan cover · Capot ventilateur · Cubierta del ventilador · Ventilatordeksel · Lüfterhaube · Fan cobertura · Copriventola · Fläktkåpa · Viftedeksel · Ventilatordæksel · Tuulettimen kansi · Кожух вентилятора
	Motor Bearings Kit · Kit Roulements moteur · Kit de rodamientos de motor · Kit rolamentos do motor · Motorlager-Kit · Motorlagers kit · Kit cuscinetto del motore · Motorlagersats · Motorlagersett · Motor lejesæt · Moottorin laakerit · Подшипники двигателя комплект
	Superpump 2" male to 1,5" female retrofit kit · Superpump 2" / 1,5" kit adaptateur · Superpump kit adaptador 2" / 1,5" · Superpump kit adaptador 2" / 1,5" · Superpump 2" / 1,5" adapter-Kit · Superpump 2" / 1,5" adapterkit · Superpump kit adattatore 2" / 1,5" · Superpump 2" hane till 1,5" hona eftermonteringsatts · Superpump 2" hann til 1,5" hun ettermonteringssett · Superpump 2" han til 1,5" hun eftermonteringssett · Superpump 2" uros-1,5" naaras jälkiasennussarja · Комплект переходников Superpump 2" / 1,5"

CONDITIONS DE GARANTIE ET EXCLUSIONS POUR LES PAYS DE L'UNION EUROPÉENNE

Les produits HAYWARD® sont garantis contre tous défauts de fabrication ou de matières pendant 3 ans, à compter de la date d'achat. Toute demande d'application de la garantie devra s'accompagner de la preuve d'achat, portant mention de la date. Nous vous conseillons donc de conserver votre facture.

Dans le cadre de sa garantie, HAYWARD® choisira de réparer ou de remplacer les produits défectueux, sous condition d'avoir été utilisés selon les instructions du guide correspondant, de n'avoir subi aucune modification, et de ne comporter que des pièces et composants d'origine. La garantie ne couvre pas les dommages dus au gel et aux produits chimiques. Tous les autres coûts (transport, main-d'oeuvre, etc.) sont exclus de la garantie.

HAYWARD® ne pourra être tenue pour responsable des dommages directs ou indirects résultant d'une installation, d'un raccordement ou d'une utilisation incorrecte du produit.

Pour toute demande de bénéfice de la garantie et de réparation ou remplacement d'un article, contacter votre revendeur.

Le retour de l'équipement en usine ne sera accepté qu'avec notre accord préalable.

Les pièces d'usure ne sont pas couvertes par la garantie.

WARRANTY CONDITIONS AND EXCLUSIONS FOR EU COUNTRIES

All HAYWARD® products are covered for manufacturing defects or material defects for a warranty period of 3 years as of date of purchases. Any warranty claim should be accompanied by evidence of purchase, indicating date of purchase. We would therefore advise you to keep your invoice.

The HAYWARD® warranty is limited to repair or replacement, as chosen by HAYWARD®, of the faulty products, provided that they have been subjected to normal use, in compliance with the guidelines given in their user guides, provided that the products have not been altered in any way, and provided that they have been used exclusively with HAYWARD® parts and components. The warranty does not cover damage due to frost and to chemicals. Any other costs (transport, labour, etc.) are excluded from the warranty.

HAYWARD® may not be held liable for any direct or indirect damage resulting from incorrect installation, incorrect connection, or incorrect operation of a product.

In order to claim on a warranty and in order to request repair or replacement of an article, please ask your dealer.

No equipment returned to our factory will be accepted without our prior written approval.

Wearing parts are not covered by the warranty.

CONDICIONES DE GARANTÍA Y EXCLUSIONES PARA PAÍSES DE LA UNIÓN EUROPEA

Todos los productos HAYWARD® están cubiertos contra defectos de fabricación o del material por un periodo de garantía de 3 años a partir de la fecha de la compra. Cualquier reclamación de garantía debe acompañarse de una prueba de compra, que indique la fecha de compra. Por consiguiente, le aconsejamos que conserve su factura.

La garantía HAYWARD® está limitada a reparaciones o sustituciones, a juicio de HAYWARD®, de los productos defectuosos, siempre que hayan sido sometidos a un uso normal, de acuerdo con las directrices ofrecidas en sus guías de usuario, y siempre que los productos no hayan sido alterados de ninguna forma, y que se hayan utilizado exclusivamente con piezas y componentes HAYWARD®. La garantía no cubre averías debidas a congelaciones o productos químicos. Cualquier otro coste (transporte, mano de obra, etc.) está excluido de la garantía.

HAYWARD® puede no asumir ninguna responsabilidad por cualquier avería directa o indirecta derivada de la instalación, conexión u operación incorrecta de un producto.

Para realizar una reclamación sobre la garantía y para solicitar la reparación o sustitución de un artículo, pregunte a su distribuidor.

No se admitirá ninguna devolución de equipos a nuestra fábrica sin nuestra aprobación previa por escrito.

La piezas sometidas a desgaste no están cubiertas por la garantía.

CONDIÇÕES DE GARANTIA E EXCLUSÕES PARA PAÍSES DA UNIÃO EUROPEIA

Todos os produtos HAYWARD® estão cobertos contra defeitos de fabrico ou de materiais através de uma garantia de 3 anos a contar da data de compra. Qualquer pedido ao abrigo da garantia deve ser acompanhado pelo comprovativo de compra, indicando a data de compra. Portanto, aconselhamos que guarde a sua factura.

A garantia HAYWARD® está limitada a reparação ou substituição, mediante critério da HAYWARD®, dos produtos com defeito, desde que tenham sido sujeitos a uma utilização normal, de acordo com as linhas de orientação indicadas no manual do utilizador e desde que não tenham sido alterados de qualquer forma que seja e tenham sido utilizados exclusivamente com peças e componentes HAYWARD®. A garantia não cobre danos provocados pelo frio ou por químicos. Quaisquer outros encargos (transporte, mão-de-obra, etc.) estão excluídos da garantia.

A HAYWARD® não pode ser responsabilizada por quaisquer danos resultantes, directa ou indirectamente, de instalação incorrecta, ligações incorrectas ou utilização incorrecta de um produto.

Para apresentar um pedido ao abrigo da garantia e para solicitar reparação ou substituição de um artigo, informe-se junto do seu agente.

Nenhum equipamento devolvido à nossa fábrica será aceite sem a nossa prévia aprovação por escrito.

Peças de desgaste não são cobertas pela garantia.

GARANTIEBEDINGUNGEN UND AUSSCHLÜSSE FÜR LÄNDER DER EUROPÄISCHEN UNION

Für ALLE Produkte von HAYWARD® gilt ab Kaufdatum eine 3-jährige Garantie auf Herstellungs- oder Materialfehler. Zur Geltendmachung der Garantie legen Sie bitte den Kaufnachweis mit dem Kaufdatum vor. Daher empfehlen wir Ihnen, den Kaufbeleg gut aufzubewahren.

Die von HAYWARD® gewährte Garantie beschränkt sich nach HAYWARD® Wahl auf die Reparatur oder den Ersatz der mangelhaften Produkte, vorausgesetzt, dass diese entsprechend den in der Benutzeranleitung gemachten Anweisungen einer normalen Benutzung unterzogen wurden, auf keinerlei Weise verändert wurden und unter der Bedingung, dass diese ausschließlich mit Bau- und Ersatzteilen von HAYWARD® verwendet wurden. Auf Frost und Chemikalien zurückzuführende Schäden sind von der Garantie ausgeschlossen. Alle anderen Kosten (Transport, Arbeitszeit etc.) sind von der Garantie ausgeschlossen.

HAYWARD® haftet nicht für direkte oder indirekte Schäden, die durch unsachgemäße Installation bzw. fehlerhaften Anschluss oder Betrieb eines Produkts entstehen.

Um einen Garantieanspruch geltend zu machen und Reparatur oder Ersatz eines Artikels anzufordern, wenden Sie sich bitte an Ihren Händler.

Ohne unsere vorherige schriftliche Zustimmung nehmen wir keine an unser Werk gesendeten Geräte an.

Verschleißteile sind von der Garantie ausgeschlossen.

GARANTIEVOORWAARDEN EN UITSLUITINGEN VOOR LANDE VAN DE EUROPESE UNIE

Op alle HAYWARD®-producten geldt een garantie van 3 jaar vanaf de aankoop voor alle materiaal- of fabricagefouten. Indien u gebruik wil maken van deze garantie, moet u het aankoopbewijs waarop de aankoopdatum vermeld staat meesturen. We raden u daarom aan uw factuur te bewaren.

De garantie van HAYWARD® is beperkt tot het herstellen of vervangen, zoals gekozen door HAYWARD®, van defecte producten, voor zover ze in normale gebruiksomstandigheden en in overeenstemming met de richtlijnen van het gebruikershandboek gebruikt werden, ze niet gewijzigd werden en uitsluitend met HAYWARD®-onderdelen en -componenten gebruikt werden. De garantie geldt niet voor schade door vorst en chemicaliën. Alle andere kosten (transport, werkuren, enz.) zijn uitgesloten van garantie.

HAYWARD® kan niet aansprakelijk worden gesteld voor directe of indirecte schade die voortvloeit uit een verkeerde installatie, een verkeerde aansluiting of een verkeerd gebruik van een product.

Om uw recht op garantie uit te oefenen en de herstelling of vervanging van een artikel aan te vragen, moet u contact met uw verdeler opnemen.

Geen enkele uitrusting die naar onze fabriek teruggestuurd wordt, wordt zonder onze voorafgaande schriftelijke goedkeuring aanvaard.

De garantie geldt niet voor reserveonderdelen

CONDIZIONI DI GARANZIA ED ESCLUSIONI PER I PAESI DELL'UNIONE EUROPEA

Tutti i prodotti HAYWARD® sono coperti contro difetti di produzione o difetti sul materiale per un periodo di 3 anni dalla data di acquisto. Ogni eventuale richiesta di intervento in garanzia deve essere accompagnata da una prova di acquisto riportante la data. Si consiglia, pertanto, di conservare la fattura o lo scontrino fiscale.

La garanzia HAYWARD® è limitata alla riparazione o sostituzione, a discrezione di HAYWARD®, dei prodotti difettosi, se oggetto di uso normale condotto secondo le istruzioni riportate nel manuale d'uso, se non alterati in alcun modo e utilizzati esclusivamente con componenti e parti originali HAYWARD®. La presente garanzia non copre i danni dovuti al gelo o legati all'azione di prodotti chimici. Ogni altro costo (trasporto, manodopera, ecc.) è escluso dalla presente garanzia.

HAYWARD® non è da ritenersi responsabile per qualsiasi danno, diretto o indiretto, derivante da un'installazione non corretta, da collegamenti erronei o da un uso improprio del prodotto.

Per usufruire della presente garanzia e richiedere un intervento di riparazione o sostituzione di un articolo, contattare il proprio rivenditore.

Nessun sistema sarà autorizzato al rientro in fabbrica senza accordo scritto preliminare.

Le parti usurabili non sono coperte da garanzia.

GARANTIVILLKOR OCH UNDANTAG FÖR EUROPEISKA UNIONENS LÄNDER

Alla produkter från Hayward® omfattas av en garanti för tillverknings- och materialfel under tre år från inköpsdagen. Vid eventuellt garantikrav ska inköpsbevis med datum bifogas. Vi rekommenderar därför att du sparar kvitto/faktura.

Garantin från Hayward är begränsad till reparation eller byte, efter Hayward® eget skön, av defekt produkt, förutsatt att denna använts på normalt sätt enligt anvisningarna i respektive användarhandledning och inte har ändrats på något sätt samt att uteslutande Hayward delar och komponenter har använts. Garantin omfattar inte skada på grund av frost eller kemikalier. Inga ytterligare kostnader (frakt, arbete m.m.) omfattas av garantin.

Hayward® kan inte hållas ansvarigt för direkt eller indirekt skada på grund felaktig installation, anslutning eller användning av produkten.

Kontakta din återförsäljare för eventuellt garantikrav, reparation eller byte av artikel.

Ingen utrustning som återsänds till vår fabrik kommer att accepteras utan vårt skriftliga godkännande i förväg.

Slitdelar omfattas inte av garantin.

GARANTIBETINGELSER OG UNDTAGELSER FOR EUROPÆISKE UNIONSLENDE

Alle HAYWARD® produkter er dækket af en garanti mod fabriktions- og materialefejl i 3 år at regne fra købsdatoen. Forskringskrav skal ledsages af et købsbevis, der viser købsdatoen. Vi anbefaler derfor, at De opbevarer fakturaen.

HAYWARD® garanti er begrænset til reparation eller ombytning efter HAYWARD® valg, af de fejlbehæftede produkter, såfremt de har været anvendt under normale forhold, og instruktionerne i brugervejledningen har været overholdt, såfremt produkterne ikke på nogen måde er blevet modificeret og såfremt de udelukkende har været anvendt sammen med HAYWARD® reservedele og komponenter. Garantien dækker ikke frost- og kemikalieskader. Alle øvrige omkostninger (transport, arbejdskraft osv.) er ikke omfattet af denne garanti.

HAYWARD® kan ikke holdes ansvarlig for direkte eller indirekte skade, der skyldes ukorrekt installation, ukorrekt tilslutning eller ukorrekt betjening af produktet.

Ved krav om garantierstatning og krav om reparation eller ombytning af en vare, bedes De henvende Dem til Deres forhandler.

Fabrikken modtager ikke returneret udstyr uden forudgående skriftlig godkendelse.

Sliddele er ikke dækket af garantien.

GARANTIBETINGELSER OG UNDTAGELSER FOR EUROPEISKE UNIONSLAND

Alle HAYWARD®-produkter dekkes med hensyn til fabriktionsfeil eller materialfeil i en periode på 3 år fra innkjøpsdatoen. Ved krav i henhold til garantien må det legges ved kjøpebevis som angir innkjøpsdato. Det anbefales derfor å ta vare på fakturaen.

HAYWARD® garanti er begrenset til reparasjon eller utskiftning, etter HAYWARD® bedømmelse, av defekte produkter, dersom disse er blitt brukt på normal måte i samsvar med retningslinjene i veiledningene, forutsatt at produktene ikke er blitt endret på noen måte og utelukkende er blitt brukt sammen med deler og komponenter fra HAYWARD®. Garantien dekker ikke skader forårsaket av frost eller kjemikalier. Alle andre kostnader (transport, arbeidstid osv.) er utelukket fra garantien.

HAYWARD® kan ikke holdes ansvarlig for direkte eller indirekte skader som skyldes feil installasjon, tilkobling eller bruk av produktet.

Vennligst ta kontakt med din forhandler med sikte på å gjøre gjeldende et krav i henhold til garantien eller be om reparasjon eller utskiftning av en artikkel.

Vi aksepterer ingen retur til fabrikken uten at vi først har gitt skriftlig samtykke.

Slitedeler dekkes ikke av garantien.

TAKUUEHDOT JA RAJOITUKSET EUROOPAN UNIONIN MAILLE

HAYWARD®IN tuotteilla on takuu valmistus- ja materiaalivikojen varalta 3 vuodelle ostopäivästä laskettuna. Kaikkien takuun sovelluspyyntöjen mukana on oltava ostotodistus, josta selviää päivämäärä. Suosittelemme siis, että säilytätte laskun.

Takuun puitteissa HAYWARD® korjaa tai vaihtaa vialliset tuotteet sillä ehdolla, että niitä on käytetty vastaavan oppaan ohjeiden mukaisesti eikä niihin ole tehty muutoksia eikä niissä ole kuin alkuperäisiä osia. Takuu ei kata jääytymisen tai kemikaalien aiheuttamia vaurioita. Mitkään muut kulut (kuljetus, työ jne.) eivät kuulu takuuseen.

HAYWARD®IA ei voida pitää vastuussa suorista tai epäsuorista vahingoista johtuen tuotteen vääränlaisesta asennuksesta, liitoksesta tai käytöstä.

Tuotteen takuusta, korjauksesta tai vaihdosta hyötymispyyntöjä varten ota yhteys jälleenmyyjääsi.

Laitteiston takaisinlähetystä tehtaalle ei hyväksytä kuin meidän etukäteen antamallamme suostumuksella.

Kuluvat osat eivät kuulu takuuseen.

ГАРАНТИЙНЫЕ УСЛОВИЯ И ИСКЛЮЧЕНИЯ ДЛЯ СТРАН ЕВРОПЕЙСКОГО СОЮЗА

На ВСЕ изделия компании «HAYWARD®» распространяется гарантия в случае обнаружения производственных либо материальных дефектов сроком на 3 года, начиная с даты покупки. К любым претензиям по гарантии следует в обязательном порядке прилагать доказательство покупки изделия, включая дату ее совершения. Поэтому мы настоятельно рекомендуем Вам сохранять и счет-фактуру вместе с товарной накладной на изделие.

Гарантия, предоставляемая на изделия компании «HAYWARD®», ограничивается ремонтом или заменой дефектных изделий по выбору компании «HAYWARD®», при условии их нормальной эксплуатации с соблюдением требований, приведенных в их «Руководствах», а также подразумевая, что изделия эти не подвергались каким-либо конструктивным изменениям и модификациям, и что использовались они исключительно вкупе с компонентами и принадлежностями, поставляемыми компанией «HAYWARD®». Гарантия не распространяется на повреждения, причиненные воздействием низких температур или химикатов. Все прочие расходы (транспорт, обслуживание и т.п.) из гарантии исключены.

Компания «HAYWARD®» не несет ответственности за любой прямой либо косвенный ущерб, понесенный вследствие ненадлежащей установки, соединения или эксплуатации изделия.

Для того, чтобы предъявить претензии по гарантии, равно как и потребовать ремонта либо замены изделия, рекомендуем Вам обращаться к своему дилеру.

Изделия, возвращенные на наш завод-изготовитель, не будут приняты без нашего предварительного письменного согласия.

Настоящая гарантия не распространяется на изнашиваемые части.

EN - ENVIRONMENTAL INFORMATION:

Provision on waste electrical and electronic equipment from professionals. In accordance with Directive 2012/19/EU on the management of waste electrical and electronic equipment, this pump must be taken to a separate collection point. ==> Contact your distributor for more information.



The proper management of electrical and electronic equipment helps to prevent damage to the environment and harm to human health. In accordance with Directive 2006/66/EC of the Council of the European Union of 6 September 2006 and with the waste that electrical and electronic equipment generates, the symbol accompanying this manual indicates that the battery incorporated in the pump must be disposed of separately.



When the battery reaches the end of its life, it should be removed and taken to a separate collection point.

FR - INFORMATIONS ENVIRONNEMENTALES:

Disposition sur les déchets d'équipements électriques et électroniques des professionnels. Conformément à la directive 2012/19/UE relative à la gestion des déchets d'équipements électriques et électroniques, cette pompe doit être déposée dans un point de collecte sélective. ==> pour plus d'informations contactez votre distributeur.



La bonne gestion des équipements électriques et électroniques contribue à prévenir les dommages à l'environnement et à la santé humaine.

Conformément à la Directive 2006/66/CE du Conseil de l'Union Européenne du 6 septembre 2006 et à leurs déchets, le symbole qui accompagne ce manuel indique la collecte sélective de la pile incorporée dans la pompe.



Lorsque la batterie arrive en fin de vie, la batterie qu'elle contient doit être retirée et déposée dans un point de collecte sélective.

Dans les pages suivantes est indiqué comment procéder pour extraire la batterie

ES - INFORMACIÓN MEDIOAMBIENTAL:

Disposición sobre residuos de aparatos eléctricos y electrónicos de profesionales. De conformidad con la Directiva 2012/19/UE sobre la gestión de residuos de aparatos eléctricos y electrónicos, esta bomba debe llevarse a un punto de recogida selectiva. ==> Póngase en contacto con su distribuidor para obtener más información.



La correcta gestión de los aparatos eléctricos y electrónicos contribuye a evitar daños al medio ambiente y a la salud humana.

De conformidad con la Directiva 2006/66/CE del Consejo de la Unión Europea de 6 de septiembre de 2006 y con los residuos que generan los equipos eléctricos y electrónicos, el símbolo que acompaña a este manual indica que la pila que incluye la bomba debe desecharse por separado.



Cuando la pila llegue al final de su vida útil, debe retirarse y llevarse a un punto de recogida selectiva.

PT - INFORMAÇÃO AMBIENTAL:

Provisão sobre resíduos de equipamentos elétricos e eletrônicos para profissionais. Em conformidade com a Diretiva 2012/19/UE relativa à gestão de resíduos de equipamentos elétricos e eletrônicos, esta bomba deve ser levada para um ponto de recolha seletiva. ==> Contacte o seu distribuidor para mais informações.



A gestão adequada de equipamentos elétricos e eletrônicos ajuda a prevenir danos ambientais e para a saúde humana.

Em conformidade com a Diretiva 2006/66/CE do Conselho da União Europeia de 6 de setembro de 2006 e com os resíduos que os equipamentos elétricos e eletrônicos geram, o símbolo que acompanha este manual indica que a bateria incorporada na bomba deve ser eliminada separadamente.



Quando a bateria atinge o fim da sua vida útil, deve ser removida e levada para um ponto de recolha seletiva.

DE - Informationen zum Umweltschutz:

Vorschriften zur Entsorgung von Elektro- und Elektronik-Altgeräten aus gewerblichem Einsatz. Gemäß der Richtlinie 2012/19/EU über Elektro- und Elektronik-Altgeräte müssen Sie diese Pumpe an eine separate Entsorgungsstelle übergeben. ==> Wenden Sie sich für weitere Informationen an Ihre Vertriebsstelle.



Die sachgerechte Entsorgung von Elektro- und Elektronik-Altgeräten vermeidet Umweltschäden und Gefahren für die Gesundheit.

Gemäß der Richtlinie 2006/66/EG des Rates der Europäischen Union vom 6. September 2006 und unter Berücksichtigung der aus Elektro- und Elektronik-Altgeräten entstehenden Abfälle schreibt das in dieser Anleitung wiedergegebene Symbol vor, die Batterie der Pumpe getrennt zu entsorgen.



Entnehmen Sie die Batterie, sobald das Ende ihrer Nutzlebensdauer erreicht ist, und übergeben Sie sie einer separaten Entsorgungsstelle.

NL - MILIEU-INFORMATIE:

Bepaling betreffende afgedankte elektrische en elektronische apparatuur. Overeenkomstig Richtlijn 2012/19/EU betreffende het beheer van afgedankte elektrische en elektronische apparatuur moet deze pomp naar een apart verzamelpunt worden gebracht. ==> Neem contact op met uw distributeur voor meer informatie.



Een goed beheer van elektrische en elektronische apparatuur draagt bij aan het voorkomen van schade aan milieu en gezondheid.

In overeenstemming met de Richtlijn 2006/66/EG van de Raad van de Europese Unie van 6 september 2006 en met het afval dat door elektrische en elektronische apparatuur wordt gegenereerd, geeft het symbool bij deze handleiding aan dat de in de pomp ingebouwde accu apart moet worden afgevoerd. Wanneer de batterij het einde van zijn levensduur heeft bereikt, moet hij worden verwijderd en naar een apart inzamelpunt worden gebracht.



IT - INFORMAZIONI AMBIENTALI:

Disposizione relativa ai rifiuti di apparecchiature elettriche ed elettroniche da parte dei professionisti. La Direttiva 2012/19/UE sulla gestione dei rifiuti di apparecchiature elettriche e elettroniche prevede il conferimento della presente pompa presso un apposito centro di raccolta. ==> Contattare il proprio distributore per ulteriori informazioni.



La gestione corretta delle apparecchiature elettriche ed elettroniche contribuisce a prevenire i danni ambientali e alla salute umana. In ottemperanza alla Direttiva 2006/66/CE del Consiglio dell'Unione Europea del 6 settembre 2006, e in considerazione dei rifiuti generati dalle apparecchiature elettriche ed elettroniche, il simbolo riportato sul presente manuale indica che la batteria incorporata nella pompa deve essere smaltita separatamente.



Una volta che si è esaurita la durata della batteria, rimuovere quest'ultima e conferirla presso un apposito centro di raccolta.

SWE - MILJÖINFORMATION:

Bestämmelse gällande avfallshantering av elektrisk och elektronisk utrustning. I enlighet med direktiv 2012/19/EU om hantering av avfall från elektrisk och elektronisk utrustning måste denna pump lämnas till en separat insamlingsplats. ==> Kontakta din distributör för mer information.



Korrekt hantering av elektrisk och elektronisk utrustning hjälper till att förhindra skador på miljön och människors hälsa. I enlighet med direktiv 2006/66/EC från Europeiska unionens råd av den 6 september 2006 och med det avfall som elektrisk och elektronisk utrustning genererar, indikerar symbolen som medföljer denna bruksanvisning att batteriet som ingår i pumpen måste kasseras separat. När batteriet når slutet av sin livslängd ska det tas bort och lämnas till en separat insamlingsplats.



DA - MILJØMÆSSIGE OPLYSNINGER:

Tilvejrbringelse af affald af elektrisk og elektronisk udstyr fra erhvervsdrivende. I overensstemmelse med direktiv 2012/19/EU om håndtering af affald af elektrisk og elektronisk udstyr skal denne pumpe afleveres til et separat indsamlingssted. ==> Kontakt din forhandler for at få flere oplysninger.



Korrekt håndtering af elektrisk og elektronisk udstyr er med til at forebygge miljøskader og skader på menneskers sundhed. I overensstemmelse med Rådets direktiv 2006/66/EF fra 6. september 2006 og med det affald, som elektrisk og elektronisk udstyr genererer, angiver det symbol, der ledsager denne manual, at batteriet i pumpen skal bortskaffes separat. Når batteriet har udtjent sin levetid, skal det fjernes og bringes til et separat indsamlingssted.



NO - MILJØINFORMASJON:

Bestemmelse om avfall av elektrisk og elektronisk utstyr fra fagfolk. I henhold til direktiv 2012/19/EU om behandling av brukt elektrisk og elektronisk utstyr må denne pumpen leveres inn til et separat innsamlingssted. ==> Ta kontakt med din distributør for mer informasjon. Riktig håndtering av elektrisk og elektronisk utstyr bidrar til å forhindre skade på miljøet og skade på menneskers helse.



I henhold til Europaparlaments- og rådsdirektiv 2006/66/EF av 6. september 2006 og med avfallet som elektrisk og elektronisk utstyr genererer, indikerer symbolet som følger med denne håndboken at batteriet som er innebygd i pumpen, må kasseres separat. Når batteriet når slutten av levetiden, må det tas ut og leveres inn til et eget innsamlingspunkt.



FI - YMPÄRISTÖTIETOJA:

Sähkö- ja elektroniikkajätettä koskeva säännös. Sähkö- ja elektroniikkajätettä käsittelevän direktiivin 2012/19/EU mukaisesti tämä pumppu on toimitettava erilliseen keräyspisteeseen. ==> Ota yhteyttä jakelijasi saadaksesi lisätietoja. Sähkö- ja elektroniikkalaitteiden asianmukainen käsittely auttaa estämään ympäristövahingot ja terveyshaitat.



Euroopan unionin neuvoston 6 päivänä syyskuuta 2006 antaman direktiivin 2006/66/EY mukaisesti sekä sähkö- ja elektroniikkalaitteiden synnyttämien jätteiden kanssa tässä käsikirjassa käytetty symboli ilmaisee, että pumpun sisältämä akku on hävitettävä erikseen. Kun akku tulee käyttöikänsä päätepisteeseen, se tulisi irrottaa ja toimittaa erilliseen keräyspisteeseen.



RU - ЭКОЛОГИЧЕСКАЯ ИНФОРМАЦИЯ

Постановление об утилизации отработанного электрического и электронного оборудования профессионального применения. В соответствии с Директивой ЕС 2012/19/EU об организации сбора и удаления отходов отработанного электрического и электронного оборудования, этот насос необходимо передать в пункт раздельного сбора отходов. ==> Дополнительную информацию можно получить у дистрибьютора.



Правильная организация сбора и удаления отходов отработанного электрического и электронного оборудования поможет избежать нанесения ущерба окружающей среде и вреда здоровью человека.

В соответствии с Директивой Совета Европейского союза 2006/66/ЕС от 6 сентября 2006 года и с учетом отходов, образующихся в результате использования электрического и электронного оборудования, условное обозначение, приведенное в этом руководстве, указывает на то, что находящуюся внутри насоса батарею необходимо утилизировать отдельно.

По окончании срока службы батареи ее следует извлечь и передать в пункт раздельного сбора отходов.



EN - Describe the procedure steps to remove the battery from the VS motor for recycling purposes.

FR - Description des étapes de la procédure de démontage de la batterie du moteur à vitesse variable, à des fins de recyclage.

ES - Descripción de los pasos del procedimiento para la retirada de la pila del motor de velocidad variable, a efectos de reciclaje.

PT - Descrição dos passos do procedimento para remover a bateria do motor de velocidade variável para fins de reciclagem.

DE - Beschreibung des Vorgehens zur Entnahme der Batterien aus dem Motor variabler Drehzahl zum Recycling.

NL - De stappen van de procedure beschrijven om de batterij uit de motor van de pomp met variabel toerental te verwijderen voor recycling.

IT - Descrizione delle fasi della procedura di rimozione della batteria del motore a velocità variabile a fini di riciclaggio.

SWE - Beskriver förfarandestegen för att ta bort batteriet från VS-motorn för återvinningsändamål.

DA - Beskriv de forskellige trin i processen for at fjerne batteriet fra VS-motoren (motor med variabel omdrejningshastighed) med henblik på genbrug.

NO - Beskriver trinnene i prosedyren med å fjerne batteriene fra motoren med variabel hastighet for resirkuleringsformål.

FI - Kuvaa prosessin vaiheet akun poistamiseksi vaihtelevanopeuksisesta moottorista kierrätystä varten.

RU - Описание шагов процедуры извлечения батареи из моторов с регулируемой частотой вращения для переработки.

EN - DESCRIPTION OF THE STEPS

•**STEP 1:** Remove the power of the pump

•**STEP 2:** Remove the user interface lid

Unscrew the four screws of the corners. After it, carefully remove the lid. A wire is connected between the UI board and the PFC board.

A Philips screwdriver should be necessary.

FR - DESCRIPTION DES ÉTAPES

•**ÉTAPE 1 :** Coupez l'alimentation à la pompe

•**ÉTAPE 2 :** Retirez le couvercle de l'interface utilisateur

Dévissez les quatre vis d'angle. Retirez ensuite délicatement le couvercle. Un câble est connecté entre la carte UI, l'interface utilisateur et la carte PFC.

Un tournevis Philips est nécessaire.

ES - DESCRIPCIÓN DE LOS PASOS

•**PASO 1:** Desconectar la alimentación de la bomba

•**PASO 2:** Retirar la tapa de la interfaz de usuario

Desatornillar los cuatro tornillos de las esquinas. A continuación, retirar con cuidado la tapa. Hay un cable conectado entre la placa UI, interfaz de usuario, y la placa PFC.

Es necesario un destornillador Philips.

PT - DESCRIÇÃO DOS PASSOS

•**PASSO 1:** Desligar a bomba da corrente elétrica

•**PASSO 2:** Remover a tampa da interface do utilizador

Desaparafuse os quatro parafusos dos cantos. Em seguida, remova cuidadosamente a tampa. Está ligado um fio entre a placa da IU e a placa PFC.

É necessária uma chave de fendas Philips.

DE - BESCHREIBUNG DER ARBEITSSCHRITTE

•**Schritt 1:** Abtrennen der Stromversorgung von der Pumpe

•**Schritt 2:** Abnehmen des Deckels der Benutzerschnittstelle

Drehen Sie die vier Schrauben an den Ecken heraus. Nehmen Sie dann den Deckel vorsichtig ab. Ein Kabel verbindet die Platinen von Benutzerschnittstelle und Leistungsfaktor-Korrektur.

Hierfür benötigen Sie einen Philips-Schraubendreher.

NL - BESCHRIJVING VAN DE STAPPEN

•**STAP 1:** De voeding van de pomp verwijderen

•**STAP 2:** Het deksel van het bedieningspaneel verwijderen

Draai de vier schroeven op de hoeken los. Verwijder daarna voorzichtig het deksel. De printplaat van het bedieningspaneel en de printplaat van de vermogensfactorcorrectie zijn met een draad verbonden.

Hiervoor hebt u een Philips schroevendraaier nodig.

IT - DESCRIZIONE DELLE FASI

•**FASE 1:** Scollegare la pompa dall'alimentazione di corrente

•**FASE 2:** Rimuovere il coperchio dell'interfaccia utente

Svitare le quattro viti dagli angoli. Dopodiché rimuovere il coperchio con cautela. La scheda dell'interfaccia utente e la scheda PFC sono collegate da un cavo.

A tal fine sarà necessario utilizzare un cacciavite Phillips.



SWE - BESKRIVNING AV STEG

•**STEG 1:** Koppla bort strömmen från pumpen

•**STEG 2:** Ta bort användargränssnittets lock

Skruva loss de fyra skruvarna i hörnen. Ta därefter försiktigt bort locket. En kabel är ansluten mellan användargränssnittets panel och effektfaktorkorrigeringskortet (PFC).

Det behövs en platt skruvmejsel.



DA - BESKRIVELSE AF DE ENKELTE TRIN

•**TRIN 1:** Afbryd pumpens strømforsyning

•**TRIN 2:** Fjerne låget til brugergrensefladen

Løsn de fire skruer i hjørnerne. Fjern derefter forsigtigt låget. Der er tilsluttet en ledning mellem UI-kortet og PFC-kortet.

Der skal bruges en Phillips skruetrækker.

NO - BESKRIVELSE AV TRINNENE

•**TRINN 1:** Koble fra strømmen til pumpen

•**TRINN 2:** Fjern brukergrensesnittlokket

Skru ut de fire skruene i hjørnene. Fjern deretter lokket forsiktig. En ledning er koblet til mellom kretskortet for brukergrensesnitt og kretskortet for effektfaktorkorrigerings.

Du vil trenge et krysskrudjern.



FI - VAIHEIDEN KUVAAUS:

•**VAIHE 1:** Poista virta pumpusta

•**VAIHE2:** Poista käyttöliitännän kansi

Kierrä irti kulmien neljä ruuvia. Poista sen jälkeen kansi varovasti. Johto on liitetty UI-piirikortin ja PFC-piirikortin väliin.

Tähän tarvitaan ristikantaruuvimeisseliä

RU - ПОШАГОВОЕ ОПИСАНИЕ

•**ШАГ 1.** Отключить электропитание насоса

•**ШАГ 2.** Извлечь логическое устройство ввода пользовательского интерфейса

Выкрутить четыре винта по углам. После этого аккуратно извлечь логическое устройство ввода.

Печатная плата пользовательского интерфейса и печатная плата компенсации коэффициента мощности соединены проводом.

Для работы потребуется крестовая отвертка.

• **EN - STEP3:** Find the battery location.

• **FR - ÉTAPE 3:** Trouvez l'emplacement de la pile.

• **ES - PASO 3:** Encontrar la ubicación de la pila.

• **PT - PASSO 3:** Encontrar a localização da bateria.

• **DE - SCHRITT 3:** Suchen sie die installationsstelle der batterie.

• **NL - STAP 3:** De plaats van de batterij zoeken.

• **IT - FASE 3:** Individuare l'ubicazione della batteria.

• **SWE - STEG 3:** Lokalisera batteriet.

• **DA - TRIN 3:** Find batteriets placering.

• **NO - TRINN 3:** Finn ut hvor batteriet sitter.

• **FI - VAIHE3:** Etsi akun sijaintipaikka.

• **RU - ШАГ 3.** Найти место установки батареи

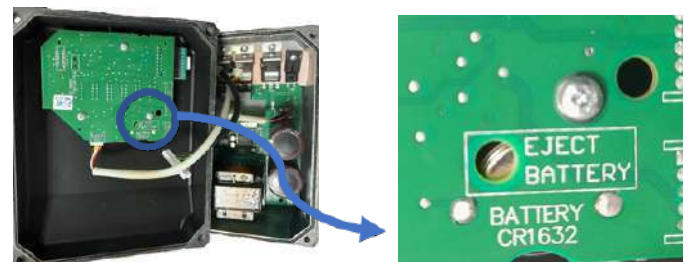

EN - STEP4: REMOVE THE BATTERY

Using a tool (small screwdriver or similar) introduce it into the hole indicated in the board for this purpose and carefully push the battery from its place.

FR - ÉTAPE 4 : RETIREZ LA BATTERIE

A l'aide d'un outil (petit tournevis ou similaire), insérez-le dans le trou indiqué sur la plaque à cet effet et retirez délicatement la batterie de son emplacement.

ES - PASO 4: RETIRAR LA PILA

Utilizando una herramienta (destornillador pequeño o similar), introducirla en el orificio indicado en la placa a tal efecto y sacar con cuidado la pila de su lugar.

PT - PASSO 4: REMOVER A BATERIA

Use uma ferramenta (chave de fendas pequena ou semelhante) e introduza-a no orifício indicado na placa para este fim e empurre cuidadosamente a bateria para fora do seu lugar.

DE - SCHRITT 4: ENTNEHMEN SIE DIE BATTERIE

Fügen Sie einen kleinen Schraubendreher oder ein ähnliches Werkzeug in die an der Platine gekennzeichnete Öffnung ein und drücken Sie die Batterie vorsichtig aus ihrer Stelle heraus

NL - STAP 4: DE BATTERIJ VERWIJDEREN

Steek een gereedschap (kleine schroevendraaier of iets dergelijks) in het daarvoor bestemde gat in de printplaat en duw de batterij voorzichtig van zijn plaats.

IT - FASE 4: RIMUOVERE LA BATTERIA

Introdurre un utensile (un piccolo cacciavite o simile) nel foro indicato sulla scheda per questa operazione, e spingere con cautela la batteria da questo punto.

SWE - STEG 4: TA UR BATTERIET

Använd ett verktyg (liten skruvmejsel eller liknande) för att föra in i hålet som anges för detta ändamål på panelen, och tryck försiktigt batteriet ut från sin plats.

DA - TRIN 4: FJERN BATTERIET

Brug et værktøj (en lille skrueetrækker eller lignende) til at føre det ind i det hul, der er angivet til dette formål, og skub forsigtigt batteriet ud

NO - TRINN 4: FJERN BATTERIET

Bruk et verktøy (lite skrujern eller lignende) og stikk det inn i hullet som indikeres i kortet til dette formål og skyv forsiktig batteriet ut av posisjon.

FI - VAIHE4: POISTA AKKU

Käytä työkalua (pieni ruuvimeisseli tai vastaava) ja vie se tähän tarkoitukseen levyssä olevaan reikään ja paina akku varovasti paikoiltaan.

RU - ШАГ 4. ИЗВЛЕЧЬ БАТАРЕЮ

Вставить инструмент (маленькую отвертку или что-то похожее) в указанное на плате отверстие и аккуратно сдвинуть батарею с места ее установки.





EN - Now, you can pick up the battery with your fingers and put it in the right place for the recycling.

FR - À ce moment-là, prenez la batterie avec vos doigts et placez-la à l'endroit approprié pour le recyclage.

ES - En ese momento, coger la pila con los dedos y colocarla en el lugar adecuado para el reciclaje de la misma.

PT - Agora, pode pegar na bateria com os dedos e colocá-la no local certo para a reciclagem.

DE - Nun können Sie sie von Hand herausnehmen und anschließend recyceln.

NL - Nu kunt u de batterij met uw vingers pakken en op de juiste plaats leggen voor de recycling.

IT - Ora sarà possibile prendere la batteria con le dita e predisporla per il riciclaggio.

SWE - Nu kan du plocka upp batteriet med fingrarna och lämna det på korrekt plats för återvinning.

DA - Nu kan batteriet samles op med fingrene og lægges på det rigtige sted til genbrug.

NO - Nå kan du plukke opp batteriet med fingrene og plassere det på riktig sted for resirkulering.

FI - Nyt voit poistaa akun sormillasi ja toimittaa sen oikeaan paikkaan kierrätystä varten.

RU - Извлечь батарею пальцами и поместить в надлежащее место для последующей переработки.

